

Yeniliđi Hisset

Işıđa Yn Ver

Feel the Innovation Direct the Light

2024/25

RN KATALOĐU
PRODUCT CATALOGUE

since 1983
Mutlusan®
electric

YENİ
NEW

Mutlusan®
CHARGEBOX

Elektrikli Araç
ŞARJ CİHAZI
Electric Vehicle Charger



"Mutlusan ChargeBox
Sürdürülebilir Güç"
"Sustainable Power"

Mutlusan®
electric

Mutlusan Chargebox ile elektrikli aracınız için güvenli, hızlı ve kolay bir şarj deneyimi yaşayın. Kalite ve güvenlikten ödün vermeden tasarlanan Chargebox, her türlü hava koşulunda yüksek performans gösterir ve şarj ihtiyacınızı en üst düzeyde karşılar.

Safe, fast, and easy charging experience for your electric vehicle with Mutlusan Chargebox. Designed without compromising on quality and safety, Chargebox delivers high performance in all weather conditions and meets your charging needs at the highest level.



Detaylı bilgi için...
For more information

f @mutlusanplastikelektrik

ig @mutlusanelectric

X @mutlusanelk

in @mutlusanelektrik

ŞALT ÜRÜNLERİ / SWITCHGEAR	02
ARAÇ ŞARJ CİHAZI / CAR CHARGER	28
MODÜLER SİSTEM / MODULAR SYSTEM	36
LİVA SERİSİ / LIVA SERIES	52
RİTA SERİSİ / RİTA SERIES	60
ELİTRA SERİSİ / ELİTRA SERIES	76
CANDELA SERİSİ / CANDELA SERIES	86
NORA SERİSİ / NORA SERIES	96
BELLA SERİSİ / BELLA SERIES	100
BRON SERİSİ / BRON SERIES	102
GRUP PRİZ VE AKSESUARLAR/ GROUP SOCKETS AND ACCESSORIES	104
KABLO KANALLARI / CABLE TRUNKING	116
İÇTEN KAPAKLI KABLO KANALLARI / CABLE TRUNKING WITH INTERNAL COVER	122
DIŞTAN KAPAKLI KABLO KANALLARI / CABLE TRUNKING WITH EXTERNAL COVER	122
MEKSPLUS SERİSİ İÇTEN KAPAKLI KANALLAR / MEKSPLUS SERIES CABLE TRUNKING WITH INTERNAL COVER	132
İÇTEN KAPAKLI KANALLAR İÇİN PRİZ MONTAJ SETLERİ / SOCKET ASSEMBLY ADAPTOR FOR INTERNAL COVER TRUNKINGS	134
BALIK SIRTİ KABLO KANALLARI / FLOOR CABLE TRUNKING	137
SİDEM SERİSİ KABLO KANALLARI / SIDEM SERIES CABLE TRUNKING	139
COMFORT W OTOMAT KUTULARI / COMFORT FUSE BOXES	140
COMFORT ZAYIF AKIM KUTULARI / COMFORT LOW CURRENT BOXES	144
MEKSBOX W OTOMAT KUTULARI / MEKSBOX FUSE BOXES	146
HALOJEN FREE SİRALLER / HALOGEN FREE SPIRALS	150
ÇELİK SİRALLER / STEEL SPIRALS	154
PLASTİK SİRALLER / PLASTIC SPIRALS	156
KORUGE BORULAR / CORRUGATED PIPES	157
LOGAR KUTULARI / MANHOLE BOXES	157
HALOJEN FREE BORULAR / HALOGEN FREE PIPES	162
PVC BORULAR VE AKSESUARLARI / PVC PIPES AND ACCESSORIES	160
PLASTİK VE ÇELİK SUSTALAR / PLASTIC CABLE PULLER AND STEEL CABLE PULLER	161
PLASTİK BORULAR / PLASTIC PIPES	167
KASA BUAT VE KAPAKLARI / JUNCTION BOXES AND JUNCTION BOX COVERS	168
KROŞE VE TOPRAKLAMA ÇUBUĞU / CABLESTRAPS AND	172
ELEKTRİK İZOLASYON BANTLARI / ELECTRICAL INSULATION TAPES	174
AKILLI KAPI KİLİDİ / SMART DOOR LOCK	176
İKAZ KORNASI, YANGIN İHBAR BUTONLARI, SİRENLER / CODE	177
ME-FAN ASPİRATÖRLER / ME-FAN FANS	180
MUTLUSAN ASPİRATÖRLER / MUTLUSAN FANS	181
EXIT ACİL AYDINLATMA ARMATÜRLERİ / CODE	182

YENİ
NEW

Şalt Grubu Switchgear



Güvenliğiniz İçin For Your Safety



Made in Türkiye



@mutusanplastikelektrik



@mutusanelectric



@mutusanelk



@mutusanelektrik



Otomatik Sigorta

Miniature Circuit Breaker (MCB)

Farklı amper değerlerinde üretilmiş olan bu otomatik sigortalar ya da diğer adıyla minyatür devre kesiciler, elektrik tesisatını ve sistemi aşırı akım ve kısa devrelere karşı korumak amacıyla tasarlanmış koruma ve anahtarlama devre elemanlarıdır. Devreden geçen akım, sigortaların nominal akımlarının belirli bir seviye üstüne çıkması durumunda ya da devrede bir kısa devre meydana gelmesi durumunda otomatik sigortalar elektrik bağlantısını keserek kendinden sonraki sistemi korumaya almaktadır.

Miniature circuit breakers, produced in different amperage values, are protection and switching circuit elements designed to protect the electrical installation and system against overcurrent and short circuits. If the current flowing through the circuit exceeds a certain level of the nominal current of the MCBs or if a short circuit occurs in the circuit, automatic MCBs protect the next system by cutting off the electrical connection.

YENİ
NEW



Yüksek kaliteli, yanmaz, 960 C polyamid 66 malzeme
The high quality unflam- mable, 960 C polyamide 66 material

Renkli kontak konumu göstergesi, cihazın durumunun ve yalıtım fonksiyonunun görsel olarak gösterilmesini sağlar.
Color coded contact position indicator provides visual indication of the device status and insulation function

B ve C tipi seçenekleriyle.
B and C type tripping curve selections.

10kA'e kadar kesme kapasitesi.
Breaking capacity up to 10kA

Kırma kolunun pozisyonu ON-I konumunda akıma açık, O-OFF durumunda akıma kapalıdır.
The position of the handle is open to current in the ON-I position, and closed to current in the O-OFF position.

- Yüksek çerçeve seviyeli çift kırılma noktası (18mm genişlik, 125A'ya kadar modül), yüksek kesme kapasitesi (10kA'e kadar).
- Hata korumalı terminal bloklarına sahip terminal ve kontak konumu gösteren pencere ile daha yüksek güvenlik.
- Akım korumalı kontak sistemi, manyetik üfleme ark seperatörü, ürünü ve ekipmanları yüksek kısa devre akımından korur, ürünlerin ark söndürme yeteneğini geliştirir, ardından kesme kapasitesinin artırılmasını sağlar.
- Gövde ve fonksiyon parçalarının tümü, yüksek alev geciktirici ve yüksek sıcaklık dayanımı, aynı zamanda darbeye dayanıklı PA66 polyamid malzemeden yapılmıştır.
- High frame level double breaking point (18mm width, module up to 125A), high breaking capacity (up to 10kA).
- Terminal with error protected terminal blocks, and higher safety with contact position indicating window.
- Current limited contact system, magnetic blow-out type arc extinguishing device, can avoid products and equipment from large short circuit current, and improve the arc extinguishing ability of products, then make sure the enhancement of breaking capacity.
- The mold and function parts are all made of PA66 polyamide material, which is highly flame retardant and high temperature resistance, also impact resistant.

İÇ YAPI STRUCTURE

Kablo bağlantısı için yüksek torklu terminal
High torque terminal for line / load power.

Bimetal
Bi-metallic strip.

Kurma kolu mekanizması
Quick make actuator mechanism

Gümüş/Bakır alaşımli kontak
Silver alloy contact

Bobin Sargısı
Coil selenoid

Hızlı&Verimli söndürücü ark
Quick & Efficient arc extinguisher

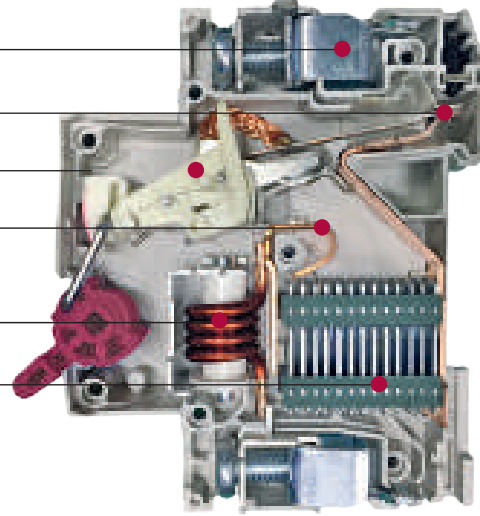

Boyutlar Dimensions

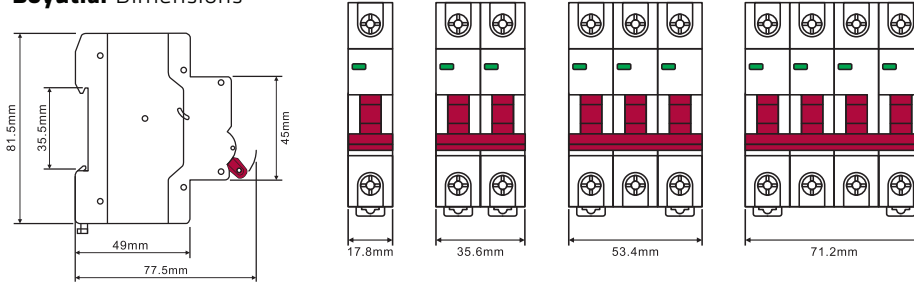

TEKNİK ÖZELLİKLER TECHNICAL SPECIFICATIONS

TIP TYPE	MTS-6				MTS-10				MTS-10H			
KUTUP SAYISI NO OF POLES	1	2	3	4	1	2	3	4	1	2	3	4
NOMINAL AKIM DERECESİ (30°C'de) RATED NOMINAL CURRENT (at 30°C)	In	A	1,2,3,4,5,6,10,16, 20,25,32,40,50,63		1,2,3,4,5,6,10,16, 20,25,32,40,50,63				80,100,125			
ANLIK TRİPPING SINIFI INSTANT TRIPPING CLASS			(B:3-5xIn) (C:5-10xIn) (D:10-20xIn)		(B:3-5xIn) (C:5-10xIn) (D:10-20xIn)				(C:5-10xIn)			
NOMINAL ÇALIŞMA GERİLİMİ RATED OPERATING VOLTAGE	Ue	AC (V)	230/400	400	230/400	400			230/400	400		
GÜÇ KAYNAĞI POWER SUPPLY			AC		AC				AC			
YALITIM GERİLİMİ DERECESİ RATED INSULATION VOLTAGE	Ui	V	690		690				690			
DARBE DAYANIM GERİLİMİ RATED IMPULSE WITHSTANDING VOLTAGE	Uimp	kV	6		6				6			
KISA DEVRE KESME KAPASİTESİ DERECESİ RATED SHORT CIRCUIT BREAKING CAPACITY	Ics	kA	6		6				6			
ENERJİ SINIRLAYICI SINIF ENERGY LIMITING CLASS			3		3				3			
ELEKTRİKSEL ÖMÜR (ÇALIŞMA) ELECTRICAL LIFE (WORKING)	op.	230V	5000		6000				5000			
MEKANİK ÖMÜR (ÇALIŞMA) MECHANICAL LIFE (WORKING)	op.		20000		20000				20000			
KORUMA SINIFI PROTECTION CLASS			IP 20		IP 20				IP 20			
ÇALIŞMA SICAKLIĞI OPERATING TEMPERATURE		°C	-30 to +60		-30 to +60				-30 to +60			
DEPOLAMA SICAKLIĞI STORAGE TEMPERATURE		°C	-40 to +70		-40 to +70				-40 to +70			
RENK COLOUR			RAL 7035		RAL 7035				RAL 7035			
MONTAJ (EN 60715) ASSEMBLY (EN 60715)			35mm DIN Rail		35mm DIN Rail				35mm DIN Rail			
MIN. MAX. BAĞLANTI KESİTİ MIN. MAX. CONNECTION SECTION		mm ²	1-25		1-25				1-25			
MAKSİMUM SIKMA TORKU MAXIMUM CLAMPING TORQUE		Nm	2,5		2,5				3,5			

B TİPİ OTOMATİK SİGORTALAR - 6kA

B TYPE MINIATURE CIRCUIT BREAKER (MCB)

YENİ
NEW

MTS06 SERİSİ

TEKNİK BİLGİLER

TECHNICAL INFORMATION



KOD CODE	KUTUP SAYISI NO OF POLES	AÇIKLAMA DESCRIPTION	KUTU BOX	KOLİ PARCEL	KUTU AĞIRLIK WEIGHT kg	KUTU HACİM VOLUME m ³
MTS06-1001B	1P	6KA 1P 1A B TİPİ OTOMATİK SİGORTA B TYPE MINIATURE CIRCUIT BREAKER (MCB)	12	240	1,164	0,001845984
MTS06-1002B	1P	6KA 1P 2A B TİPİ OTOMATİK SİGORTA B TYPE MINIATURE CIRCUIT BREAKER (MCB)	12	240	1,16196	0,001845984
MTS06-1003B	1P	6KA 1P 3A B TİPİ OTOMATİK SİGORTA B TYPE MINIATURE CIRCUIT BREAKER (MCB)	12	240	1,16196	0,001845984
MTS06-1004B	1P	6KA 1P 4A B TİPİ OTOMATİK SİGORTA B TYPE MINIATURE CIRCUIT BREAKER (MCB)	12	240	1,19796	0,001845984
MTS06-1005B	1P	6KA 1P 5A B TİPİ OTOMATİK SİGORTA B TYPE MINIATURE CIRCUIT BREAKER (MCB)	12	240	1,22196	0,001845984
MTS06-1006B	1P	6KA 1P 6A B TİPİ OTOMATİK SİGORTA B TYPE MINIATURE CIRCUIT BREAKER (MCB)	12	240	1,176	0,001845984
MTS06-1010B	1P	6KA 1P 10A B TİPİ OTOMATİK SİGORTA B TYPE MINIATURE CIRCUIT BREAKER (MCB)	12	240	1,176	0,001845984
MTS06-1016B	1P	6KA 1P 16A B TİPİ OTOMATİK SİGORTA B TYPE MINIATURE CIRCUIT BREAKER (MCB)	12	240	1,176	0,001845984
MTS06-1020B	1P	6KA 1P 20A B TİPİ OTOMATİK SİGORTA B TYPE MINIATURE CIRCUIT BREAKER (MCB)	12	240	1,188	0,001845984
MTS06-1025B	1P	6KA 1P 25A B TİPİ OTOMATİK SİGORTA B TYPE MINIATURE CIRCUIT BREAKER (MCB)	12	240	1,188	0,001845984
MTS06-1032B	1P	6KA 1P 32A B TİPİ OTOMATİK SİGORTA B TYPE MINIATURE CIRCUIT BREAKER (MCB)	12	240	1,2	0,001845984
MTS06-1040B	1P	6KA 1P 40A B TİPİ OTOMATİK SİGORTA B TYPE MINIATURE CIRCUIT BREAKER (MCB)	12	240	1,188	0,001845984
MTS06-1050B	1P	6KA 1P 50A B TİPİ OTOMATİK SİGORTA B TYPE MINIATURE CIRCUIT BREAKER (MCB)	12	240	1,188	0,001845984
MTS06-1063B	1P	6KA 1P 63A B TİPİ OTOMATİK SİGORTA B TYPE MINIATURE CIRCUIT BREAKER (MCB)	12	240	1,188	0,001845984
MTS06-2001B	2P	6KA 2P 1A B TİPİ OTOMATİK SİGORTA B TYPE MINIATURE CIRCUIT BREAKER (MCB)	6	120	1,17402	0,00184599
MTS06-2002B	2P	6KA 2P 2A B TİPİ OTOMATİK SİGORTA B TYPE MINIATURE CIRCUIT BREAKER (MCB)	6	120	1,17402	0,00184599
MTS06-2003B	2P	6KA 2P 3A B TİPİ OTOMATİK SİGORTA B TYPE MINIATURE CIRCUIT BREAKER (MCB)	6	120	1,158	0,00184599
MTS06-2004B	2P	6KA 2P 4A B TİPİ OTOMATİK SİGORTA B TYPE MINIATURE CIRCUIT BREAKER (MCB)	6	120	1,24002	0,00184599
MTS06-2005B	2P	6KA 2P 5A B TİPİ OTOMATİK SİGORTA B TYPE MINIATURE CIRCUIT BREAKER (MCB)	6	120	1,24002	0,00184599
MTS06-2006B	2P	6KA 2P 6A B TİPİ OTOMATİK SİGORTA B TYPE MINIATURE CIRCUIT BREAKER (MCB)	6	120	1,17402	0,00184599
MTS06-2010B	2P	6KA 2P 10A B TİPİ OTOMATİK SİGORTA B TYPE MINIATURE CIRCUIT BREAKER (MCB)	6	120	1,236	0,00184599
MTS06-2016B	2P	6KA 2P 16A B TİPİ OTOMATİK SİGORTA B TYPE MINIATURE CIRCUIT BREAKER (MCB)	6	120	1,296	0,00184599
MTS06-2020B	2P	6KA 2P 20A B TİPİ OTOMATİK SİGORTA B TYPE MINIATURE CIRCUIT BREAKER (MCB)	6	120	1,22202	0,00184599
MTS06-2025B	2P	6KA 2P 25A B TİPİ OTOMATİK SİGORTA B TYPE MINIATURE CIRCUIT BREAKER (MCB)	6	120	1,224	0,00184599
MTS06-2032B	2P	6KA 2P 32A B TİPİ OTOMATİK SİGORTA B TYPE MINIATURE CIRCUIT BREAKER (MCB)	6	120	1,206	0,00184599
MTS06-2040B	2P	6KA 2P 40A B TİPİ OTOMATİK SİGORTA B TYPE MINIATURE CIRCUIT BREAKER (MCB)	6	120	1,128	0,00184599
MTS06-2050B	2P	6KA 2P 50A B TİPİ OTOMATİK SİGORTA B TYPE MINIATURE CIRCUIT BREAKER (MCB)	6	120	1,19802	0,00184599
MTS06-2063B	2P	6KA 2P 63A B TİPİ OTOMATİK SİGORTA B TYPE MINIATURE CIRCUIT BREAKER (MCB)	6	120	1,14402	0,00184599
MTS06-3001B	3P	6KA 3P 1A B TİPİ OTOMATİK SİGORTA B TYPE MINIATURE CIRCUIT BREAKER (MCB)	4	80	1,166	0,001845988
MTS06-3002B	3P	6KA 3P 2A B TİPİ OTOMATİK SİGORTA B TYPE MINIATURE CIRCUIT BREAKER (MCB)	4	80	1,166	0,001845988
MTS06-3003B	3P	6KA 3P 3A B TİPİ OTOMATİK SİGORTA B TYPE MINIATURE CIRCUIT BREAKER (MCB)	4	80	1,17	0,001845988
MTS06-3004B	3P	6KA 3P 4A B TİPİ OTOMATİK SİGORTA B TYPE MINIATURE CIRCUIT BREAKER (MCB)	4	80	1,226	0,001845988
MTS06-3005B	3P	6KA 3P 5A B TİPİ OTOMATİK SİGORTA B TYPE MINIATURE CIRCUIT BREAKER (MCB)	4	80	1,202	0,001845988
MTS06-3006B	3P	6KA 3P 6A B TİPİ OTOMATİK SİGORTA B TYPE MINIATURE CIRCUIT BREAKER (MCB)	4	80	1,134	0,001845988
MTS06-3010B	3P	6KA 3P 10A B TİPİ OTOMATİK SİGORTA B TYPE MINIATURE CIRCUIT BREAKER (MCB)	4	80	1,176	0,001845988
MTS06-3016B	3P	6KA 3P 16A B TİPİ OTOMATİK SİGORTA B TYPE MINIATURE CIRCUIT BREAKER (MCB)	4	80	1,196	0,001845988
MTS06-3020B	3P	6KA 3P 20A B TİPİ OTOMATİK SİGORTA B TYPE MINIATURE CIRCUIT BREAKER (MCB)	4	80	1,116	0,001845988
MTS06-3025B	3P	6KA 3P 25A B TİPİ OTOMATİK SİGORTA B TYPE MINIATURE CIRCUIT BREAKER (MCB)	4	80	1,096	0,001845988
MTS06-3032B	3P	6KA 3P 32A B TİPİ OTOMATİK SİGORTA B TYPE MINIATURE CIRCUIT BREAKER (MCB)	4	80	1,104	0,001845988
MTS06-3040B	3P	6KA 3P 40A B TİPİ OTOMATİK SİGORTA B TYPE MINIATURE CIRCUIT BREAKER (MCB)	4	80	1,112	0,001845988
MTS06-3050B	3P	6KA 3P 50A B TİPİ OTOMATİK SİGORTA B TYPE MINIATURE CIRCUIT BREAKER (MCB)	4	80	1,168	0,001845988
MTS06-3063B	3P	6KA 3P 63A B TİPİ OTOMATİK SİGORTA B TYPE MINIATURE CIRCUIT BREAKER (MCB)	4	80	1,172	0,001845988
MTS06-4001B	4P	6KA 4P 1A B TİPİ OTOMATİK SİGORTA B TYPE MINIATURE CIRCUIT BREAKER (MCB)	3	60	1,22199	0,001845987
MTS06-4002B	4P	6KA 4P 2A B TİPİ OTOMATİK SİGORTA B TYPE MINIATURE CIRCUIT BREAKER (MCB)	3	60	1,16799	0,001845987
MTS06-4003B	4P	6KA 4P 3A B TİPİ OTOMATİK SİGORTA B TYPE MINIATURE CIRCUIT BREAKER (MCB)	3	60	1,15299	0,001845987
MTS06-4004B	4P	6KA 4P 4A B TİPİ OTOMATİK SİGORTA B TYPE MINIATURE CIRCUIT BREAKER (MCB)	3	60	1,23099	0,001845987
MTS06-4005B	4P	6KA 4P 5A B TİPİ OTOMATİK SİGORTA B TYPE MINIATURE CIRCUIT BREAKER (MCB)	3	60	1,19199	0,001845987
MTS06-4006B	4P	6KA 4P 6A B TİPİ OTOMATİK SİGORTA B TYPE MINIATURE CIRCUIT BREAKER (MCB)	3	60	1,17699	0,001845987
MTS06-4010B	4P	6KA 4P 10A B TİPİ OTOMATİK SİGORTA B TYPE MINIATURE CIRCUIT BREAKER (MCB)	3	60	1,14699	0,001845987
MTS06-4016B	4P	6KA 4P 16A B TİPİ OTOMATİK SİGORTA B TYPE MINIATURE CIRCUIT BREAKER (MCB)	3	60	1,12899	0,001845987
MTS06-4020B	4P	6KA 4P 20A B TİPİ OTOMATİK SİGORTA B TYPE MINIATURE CIRCUIT BREAKER (MCB)	3	60	1,15299	0,001845987
MTS06-4025B	4P	6KA 4P 25A B TİPİ OTOMATİK SİGORTA B TYPE MINIATURE CIRCUIT BREAKER (MCB)	3	60	1,092	0,001845987
MTS06-4032B	4P	6KA 4P 32A B TİPİ OTOMATİK SİGORTA B TYPE MINIATURE CIRCUIT BREAKER (MCB)	3	60	1,095	0,001845987
MTS06-4040B	4P	6KA 4P 40A B TİPİ OTOMATİK SİGORTA B TYPE MINIATURE CIRCUIT BREAKER (MCB)	3	60	1,125	0,001845987
MTS06-4050B	4P	6KA 4P 50A B TİPİ OTOMATİK SİGORTA B TYPE MINIATURE CIRCUIT BREAKER (MCB)	3	60	1,206	0,001845987
MTS06-4063B	4P	6KA 4P 63A B TİPİ OTOMATİK SİGORTA B TYPE MINIATURE CIRCUIT BREAKER (MCB)	3	60	1,19199	0,001845987

C TİPİ OTOMATİK SİGORTALAR - 6kA

C TYPE MINIATURE CIRCUIT BREAKER (MCB)

YENİ
NEW



MTS06 SERİSİ

TEKNİK BİLGİLER
TECHNICAL INFORMATION

KOD CODE	KUTUP SAYISI NO OF POLES	AÇIKLAMA DESCRIPTION	KUTU BOX	KOLİ PARCEL	KUTU AĞIRLIK BOX WEIGHT kg	KUTU HACİM BOX VOLUME m ³
MTS06-1001C	1P	6KA 1P 1A C TİPİ OTOMATİK SİGORTA C TYPE MINIATURE CIRCUIT BREAKER (MCB)	12	240	1,16196	0,001845984
MTS06-1002C	1P	6KA 1P 2A C TİPİ OTOMATİK SİGORTA C TYPE MINIATURE CIRCUIT BREAKER (MCB)	12	240	1,16196	0,001845984
MTS06-1003C	1P	6KA 1P 3A C TİPİ OTOMATİK SİGORTA C TYPE MINIATURE CIRCUIT BREAKER (MCB)	12	240	1,16196	0,001845984
MTS06-1004C	1P	6KA 1P 4A C TİPİ OTOMATİK SİGORTA C TYPE MINIATURE CIRCUIT BREAKER (MCB)	12	240	1,19796	0,001845984
MTS06-1005C	1P	6KA 1P 5A C TİPİ OTOMATİK SİGORTA C TYPE MINIATURE CIRCUIT BREAKER (MCB)	12	240	1,22196	0,001845984
MTS06-1006C	1P	6KA 1P 6A C TİPİ OTOMATİK SİGORTA C TYPE MINIATURE CIRCUIT BREAKER (MCB)	12	240	1,176	0,001845984
MTS06-1010C	1P	6KA 1P 10A C TİPİ OTOMATİK SİGORTA C TYPE MINIATURE CIRCUIT BREAKER (MCB)	12	240	1,176	0,001845984
MTS06-1016C	1P	6KA 1P 16A C TİPİ OTOMATİK SİGORTA C TYPE MINIATURE CIRCUIT BREAKER (MCB)	12	240	1,176	0,001845984
MTS06-1020C	1P	6KA 1P 20A C TİPİ OTOMATİK SİGORTA C TYPE MINIATURE CIRCUIT BREAKER (MCB)	12	240	1,188	0,001845984
MTS06-1025C	1P	6KA 1P 25A C TİPİ OTOMATİK SİGORTA C TYPE MINIATURE CIRCUIT BREAKER (MCB)	12	240	1,188	0,001845984
MTS06-1032C	1P	6KA 1P 32A C TİPİ OTOMATİK SİGORTA C TYPE MINIATURE CIRCUIT BREAKER (MCB)	12	240	1,19796	0,001845984
MTS06-1040C	1P	6KA 1P 40A C TİPİ OTOMATİK SİGORTA C TYPE MINIATURE CIRCUIT BREAKER (MCB)	12	240	1,188	0,001845984
MTS06-1050C	1P	6KA 1P 50A C TİPİ OTOMATİK SİGORTA C TYPE MINIATURE CIRCUIT BREAKER (MCB)	12	240	1,18596	0,001845984
MTS06-1063C	1P	6KA 1P 63A C TİPİ OTOMATİK SİGORTA C TYPE MINIATURE CIRCUIT BREAKER (MCB)	12	240	1,18596	0,001845984
MTS06-2001C	2P	6KA 2P 1A C TİPİ OTOMATİK SİGORTA C TYPE MINIATURE CIRCUIT BREAKER (MCB)	6	120	1,17402	0,00184599
MTS06-2002C	2P	6KA 2P 2A C TİPİ OTOMATİK SİGORTA C TYPE MINIATURE CIRCUIT BREAKER (MCB)	6	120	1,17402	0,00184599
MTS06-2003C	2P	6KA 2P 3A C TİPİ OTOMATİK SİGORTA C TYPE MINIATURE CIRCUIT BREAKER (MCB)	6	120	1,15602	0,00184599
MTS06-2004C	2P	6KA 2P 4A C TİPİ OTOMATİK SİGORTA C TYPE MINIATURE CIRCUIT BREAKER (MCB)	6	120	1,24002	0,00184599
MTS06-2005C	2P	6KA 2P 5A C TİPİ OTOMATİK SİGORTA C TYPE MINIATURE CIRCUIT BREAKER (MCB)	6	120	1,24002	0,00184599
MTS06-2006C	2P	6KA 2P 6A C TİPİ OTOMATİK SİGORTA C TYPE MINIATURE CIRCUIT BREAKER (MCB)	6	120	1,17402	0,00184599
MTS06-2010C	2P	6KA 2P 10A C TİPİ OTOMATİK SİGORTA C TYPE MINIATURE CIRCUIT BREAKER (MCB)	6	120	1,23402	0,00184599
MTS06-2016C	2P	6KA 2P 16A C TİPİ OTOMATİK SİGORTA C TYPE MINIATURE CIRCUIT BREAKER (MCB)	6	120	1,29402	0,00184599
MTS06-2020C	2P	6KA 2P 20A C TİPİ OTOMATİK SİGORTA C TYPE MINIATURE CIRCUIT BREAKER (MCB)	6	120	1,22202	0,00184599
MTS06-2025C	2P	6KA 2P 25A C TİPİ OTOMATİK SİGORTA C TYPE MINIATURE CIRCUIT BREAKER (MCB)	6	120	1,22202	0,00184599
MTS06-2032C	2P	6KA 2P 32A C TİPİ OTOMATİK SİGORTA C TYPE MINIATURE CIRCUIT BREAKER (MCB)	6	120	1,20402	0,00184599
MTS06-2040C	2P	6KA 2P 40A C TİPİ OTOMATİK SİGORTA C TYPE MINIATURE CIRCUIT BREAKER (MCB)	6	120	1,12602	0,00184599
MTS06-2050C	2P	6KA 2P 50A C TİPİ OTOMATİK SİGORTA C TYPE MINIATURE CIRCUIT BREAKER (MCB)	6	120	1,19802	0,00184599
MTS06-2063C	2P	6KA 2P 63A C TİPİ OTOMATİK SİGORTA C TYPE MINIATURE CIRCUIT BREAKER (MCB)	6	120	1,146	0,00184599
MTS06-3001C	3P	6KA 3P 1A C TİPİ OTOMATİK SİGORTA C TYPE MINIATURE CIRCUIT BREAKER (MCB)	4	80	1,166	0,001845988
MTS06-3002C	3P	6KA 3P 2A C TİPİ OTOMATİK SİGORTA C TYPE MINIATURE CIRCUIT BREAKER (MCB)	4	80	1,168	0,001845988
MTS06-3003C	3P	6KA 3P 3A C TİPİ OTOMATİK SİGORTA C TYPE MINIATURE CIRCUIT BREAKER (MCB)	4	80	1,17	0,001845988
MTS06-3004C	3P	6KA 3P 4A C TİPİ OTOMATİK SİGORTA C TYPE MINIATURE CIRCUIT BREAKER (MCB)	4	80	1,226	0,001845988
MTS06-3005C	3P	6KA 3P 5A C TİPİ OTOMATİK SİGORTA C TYPE MINIATURE CIRCUIT BREAKER (MCB)	4	80	1,202	0,001845988
MTS06-3006C	3P	6KA 3P 6A C TİPİ OTOMATİK SİGORTA C TYPE MINIATURE CIRCUIT BREAKER (MCB)	4	80	1,134	0,001845988
MTS06-3010C	3P	6KA 3P 10A C TİPİ OTOMATİK SİGORTA C TYPE MINIATURE CIRCUIT BREAKER (MCB)	4	80	1,174	0,001845988
MTS06-3016C	3P	6KA 3P 16A C TİPİ OTOMATİK SİGORTA C TYPE MINIATURE CIRCUIT BREAKER (MCB)	4	80	1,196	0,001845988
MTS06-3020C	3P	6KA 3P 20A C TİPİ OTOMATİK SİGORTA C TYPE MINIATURE CIRCUIT BREAKER (MCB)	4	80	1,114	0,001845988
MTS06-3025C	3P	6KA 3P 25A C TİPİ OTOMATİK SİGORTA C TYPE MINIATURE CIRCUIT BREAKER (MCB)	4	80	1,16052	0,001845988
MTS06-3032C	3P	6KA 3P 32A C TİPİ OTOMATİK SİGORTA C TYPE MINIATURE CIRCUIT BREAKER (MCB)	4	80	1,16	0,001845988
MTS06-3040C	3P	6KA 3P 40A C TİPİ OTOMATİK SİGORTA C TYPE MINIATURE CIRCUIT BREAKER (MCB)	4	80	1,16052	0,001845988
MTS06-3050C	3P	6KA 3P 50A C TİPİ OTOMATİK SİGORTA C TYPE MINIATURE CIRCUIT BREAKER (MCB)	4	80	1,168	0,001845988
MTS06-3063C	3P	6KA 3P 63A C TİPİ OTOMATİK SİGORTA C TYPE MINIATURE CIRCUIT BREAKER (MCB)	4	80	1,172	0,001845988
MTS06-4001C	4P	6KA 4P 1A C TİPİ OTOMATİK SİGORTA C TYPE MINIATURE CIRCUIT BREAKER (MCB)	3	60	1,22199	0,001845987
MTS06-4002C	4P	6KA 4P 2A C TİPİ OTOMATİK SİGORTA C TYPE MINIATURE CIRCUIT BREAKER (MCB)	3	60	1,16799	0,001845987
MTS06-4003C	4P	6KA 4P 3A C TİPİ OTOMATİK SİGORTA C TYPE MINIATURE CIRCUIT BREAKER (MCB)	3	60	1,15299	0,001845987
MTS06-4004C	4P	6KA 4P 4A C TİPİ OTOMATİK SİGORTA C TYPE MINIATURE CIRCUIT BREAKER (MCB)	3	60	1,23099	0,001845987
MTS06-4005C	4P	6KA 4P 5A C TİPİ OTOMATİK SİGORTA C TYPE MINIATURE CIRCUIT BREAKER (MCB)	3	60	1,19199	0,001845987
MTS06-4006C	4P	6KA 4P 6A C TİPİ OTOMATİK SİGORTA C TYPE MINIATURE CIRCUIT BREAKER (MCB)	3	60	1,17699	0,001845987
MTS06-4010C	4P	6KA 4P 10A C TİPİ OTOMATİK SİGORTA C TYPE MINIATURE CIRCUIT BREAKER (MCB)	3	60	1,14699	0,001845987
MTS06-4016C	4P	6KA 4P 16A C TİPİ OTOMATİK SİGORTA C TYPE MINIATURE CIRCUIT BREAKER (MCB)	3	60	1,128	0,001845987
MTS06-4020C	4P	6KA 4P 20A C TİPİ OTOMATİK SİGORTA C TYPE MINIATURE CIRCUIT BREAKER (MCB)	3	60	1,15299	0,001845987
MTS06-4025C	4P	6KA 4P 25A C TİPİ OTOMATİK SİGORTA C TYPE MINIATURE CIRCUIT BREAKER (MCB)	3	60	1,164	0,001845987
MTS06-4032C	4P	6KA 4P 32A C TİPİ OTOMATİK SİGORTA C TYPE MINIATURE CIRCUIT BREAKER (MCB)	3	60	1,1625	0,001845987
MTS06-4040C	4P	6KA 4P 40A C TİPİ OTOMATİK SİGORTA C TYPE MINIATURE CIRCUIT BREAKER (MCB)	3	60	1,164	0,001845987
MTS06-4050C	4P	6KA 4P 50A C TİPİ OTOMATİK SİGORTA C TYPE MINIATURE CIRCUIT BREAKER (MCB)	3	60	1,206	0,001845987
MTS06-4063C	4P	6KA 4P 63A C TİPİ OTOMATİK SİGORTA C TYPE MINIATURE CIRCUIT BREAKER (MCB)	3	60	1,191	0,001845987

C TİPİ OTOMATİK SİGORTALAR - 10kA

C TYPE MINIATURE CIRCUIT BREAKER (MCB)

YENİ
NEW



MTS10H SERİSİ

TEKNİK BİLGİLER
TECHNICAL INFORMATION

KOD CODE	KUTUP SAYISI NO OF POLES	AÇIKLAMA DESCRIPTION	KUTU BOX	KOLİ PARCEL	KUTU AĞIRLIK BOX WEIGHT kg	KUTU HACİM BOX VOLUME m ³
MTS10-1080C	1P	10KA 1P 80A C TİPİ OTOMATİK SİGORTA C TYPE MINIATURE CIRCUIT BREAKER (MCB)	12	240	1,52196	0,001845984
MTS10-1100C	1P	10KA 1P 100A C TİPİ OTOMATİK SİGORTA C TYPE MINIATURE CIRCUIT BREAKER (MCB)	12	240	1,52196	0,001845984
MTS10-1125C	1P	10KA 1P 125A C TİPİ OTOMATİK SİGORTA C TYPE MINIATURE CIRCUIT BREAKER (MCB)	12	240	1,52196	0,001845984
MTS10-2080C	2P	10KA 2P 80A C TİPİ OTOMATİK SİGORTA C TYPE MINIATURE CIRCUIT BREAKER (MCB)	6	120	1,52802	0,00184599
MTS10-2100C	2P	10KA 2P 100A C TİPİ OTOMATİK SİGORTA C TYPE MINIATURE CIRCUIT BREAKER (MCB)	6	120	1,52802	0,00184599
MTS10-2125C	2P	10KA 2P 125A C TİPİ OTOMATİK SİGORTA C TYPE MINIATURE CIRCUIT BREAKER (MCB)	6	120	1,54002	0,00184599
MTS10-3080C	3P	10KA 3P 80A C TİPİ OTOMATİK SİGORTA C TYPE MINIATURE CIRCUIT BREAKER (MCB)	4	80	1,518	0,001845988
MTS10-3100C	3P	10KA 3P 100A C TİPİ OTOMATİK SİGORTA C TYPE MINIATURE CIRCUIT BREAKER (MCB)	4	80	1,522	0,001845988
MTS10-3125C	3P	10KA 3P 125A C TİPİ OTOMATİK SİGORTA C TYPE MINIATURE CIRCUIT BREAKER (MCB)	4	80	1,534	0,001845988
MTS10-4080C	4P	10KA 4P 80A C TİPİ OTOMATİK SİGORTA C TYPE MINIATURE CIRCUIT BREAKER (MCB)	3	60	1,50999	0,001845987
MTS10-4100C	4P	10KA 4P 100A C TİPİ OTOMATİK SİGORTA C TYPE MINIATURE CIRCUIT BREAKER (MCB)	3	60	1,50999	0,001845987
MTS10-4125C	4P	10KA 4P 125A C TİPİ OTOMATİK SİGORTA C TYPE MINIATURE CIRCUIT BREAKER (MCB)	3	60	1,52199	0,001845987

OTOMATİK SİGORTA YARDIMCI KONTAKLARI

AUTOMATIC FUSE AUXILIARY CONTACTS

TEKNİK BİLGİLER
TECHNICAL INFORMATION

KOD CODE	AÇIKLAMA DESCRIPTION	KUTU BOX	KOLİ PARCEL	KUTU AĞIRLIK BOX WEIGHT kg	KUTU HACİM BOX VOLUME m ³
MTSAUX-AC12	OTOMATİK SİGORTA YARDIMCI KONTAK 12VAC AUTOMATIC FUSE AUXILIARY CONTACTS	10	396	0,3535	0,00086584



FAZ+NÖTR SİGORTA

MINIATURE CIRCUIT BREAKER PHASE+NEUTRAL
(DPN MCB)

Tek fazlı elektrik devrelerinde kullanılan bu tür minyatür devre kesiciler aşırı akım ve kısa devre durumunda hem fazı hem de nötrü koruma altına alırlar.

Circuit breakers of this type used in single-phase electrical circuits protect both phase and neutral in case of overcurrent and short circuit.



YENİ
NEW

- Aşırı akım ve kısa devre durumlarında devreyi güvenli bir şekilde keserler.
- Otomatik sigorta faz+nötr devre kesiciler genellikle konut ve hafif ticari alanlarda, özellikle de faz ve nötr hattının birlikte korunması gereken durumlarda tercih edilir.
- Kompakt tasarımı kolay kurulum sağlarken, hızlı tepki süresi aşırı akım ve kısa devre risklerine karşı etkin koruma yapar.
- Aşırı akım/kısa devre koruması yangın ve elektrik çarpması riskini azaltır.
- They safely break the circuit in cases of overcurrent and short circuit.
- DPN MCB phase+neutral circuit breakers are generally preferred in residential and light commercial areas, especially in cases where the phase and neutral lines must be protected together.
- While its compact design provides easy installation, its fast response time provides effective protection against current and short circuit risks.
- Overcurrent/short circuit protection reduces the risk of fire and electric shock.

MTS04LN SERİSİ

TEKNİK BİLGİLER
TECHNICAL INFORMATION

KOD CODE	KUTUP SAYISI NO OF POLES	AÇIKLAMA DESCRIPTION	KUTU BOX	KOLİ PARCEL	KUTU AĞIRLIK BOX WEIGHT kg	KUTU HACİM BOX VOLUME m3
MTS04-106CN	1P + N	4.5KA 1P+N 6A OTOMATİK SİGORTA MINIATURE CIRCUIT BREAKER	12	240	1,17504	0,0017487
MTS04-110CN	1P + N	4.5KA 1P+N 10A OTOMATİK SİGORTA MINIATURE CIRCUIT BREAKER	12	240	1,17504	0,0017487
MTS04-116CN	1P + N	4.5KA 1P+N 16A OTOMATİK SİGORTA MINIATURE CIRCUIT BREAKER	12	240	1,17504	0,0017487
MTS04-120CN	1P + N	4.5KA 1P+N 20A OTOMATİK SİGORTA MINIATURE CIRCUIT BREAKER	12	240	1,17504	0,0017487
MTS04-125CN	1P + N	4.5KA 1P+N 25A OTOMATİK SİGORTA MINIATURE CIRCUIT BREAKER	12	240	1,17504	0,0017487
MTS04-132CN	1P + N	4.5KA 1P+N 32A OTOMATİK SİGORTA MINIATURE CIRCUIT BREAKER	12	240	1,17504	0,0017487
MTS04-140CN	1P + N	4.5KA 1P+N 40A OTOMATİK SİGORTA MINIATURE CIRCUIT BREAKER	12	240	1,17504	0,0017487

**"Kaçak Akımda Güvenlik,
Devrede Güvence."**
"Security in Leakage,
Security in Circuit Current."



Kaçak Akım Devre Koruma Residual Current Circuit Breaker (RCCB)

Elektrik devrelerinde insanları elektrik çarpmasına karşı korumak için tasarlanmış bir güvenlik cihazıdır. Devredeki faz ve nötr akımlarını sürekli olarak izler ve bu akımlar arasında bir dengesizlik (kaçak akım) tespit ettiğinde, elektrik akışını otomatik olarak keserek devreyi güvenli bir hale getirir. Elektrik çarpmalarının yanı sıra elektrik yangınlarının önlenmesine de yardımcı olur. AC ve A tipi olmak üzere 30mA-300mA aralığında 6A den 100A e kadar mevcuttur..

It is a safety device designed to protect people against electric shock in electrical circuits. It constantly monitors the phase and neutral currents in the circuit, and when it detects an imbalance (leakage current) between these currents, it automatically cuts off the electrical flow and makes the circuit safe. It helps prevent electrical fires as well as electric shocks. It is available in the range of 30mA-300mA, from 6A to 100A, including AC and A type.

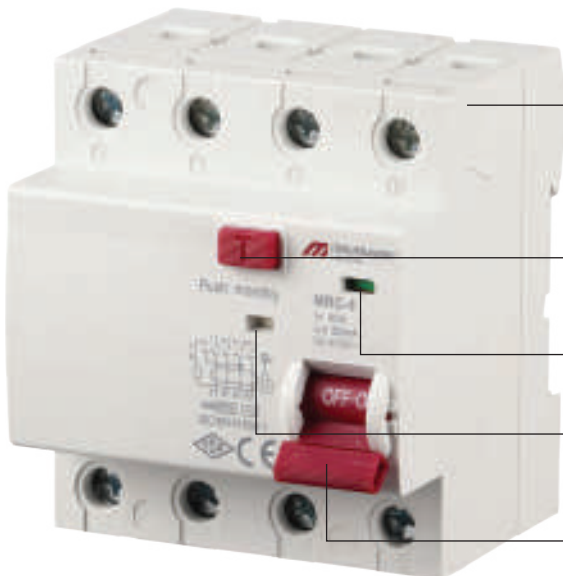

Yüksek kaliteli, yanmaz,
960 C polyamid 66 malzeme
The high quality unflam- mable,
960 C polyamide 66 material

Test Butonu
Test button

Kontakt Durumu Göstergesi
Contact position indicator

Gösterge
Trip indicator

Ergonomik Kurma Kolu
Ergonomic On/Off Lever

Çift İndikatör (Eğer cihaz, kaçak akım nedeniyle trip ettiyse test butonunun altındaki indikatör kırmızıya dönmektedir. Bu şekilde hattın kaçak nedeniyle mi yoksa el ile mi şalterin indirildiği anlaşıl- maktadır.

Double Indicator (If the device has tripped due to leakage current, the indicator under the test button turns red. In this way, it is understood whether the line is due to leakage or whether the switch is turned off manually.

KAÇAK AKIM DEVRE KORUMA

RESIDUAL CURRENT CIRCUIT BREAKER (RCCB)

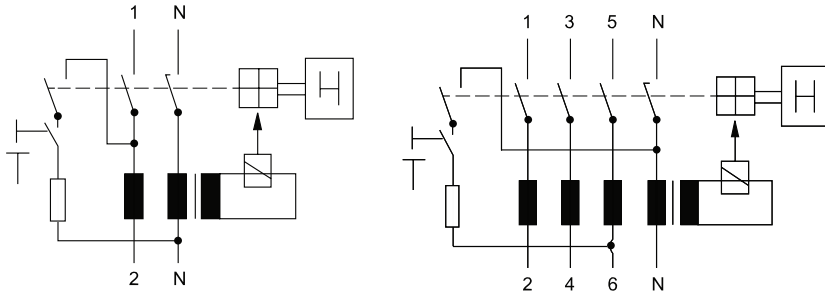

BOYUTLAR DIMENSIONS

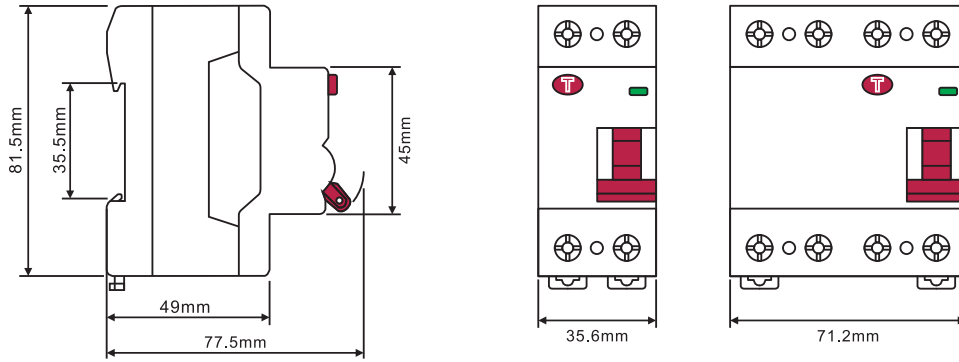

TEKNİK ÖZELLİKLER TECHNICAL SPECIFICATIONS

TİP TYPE			MRC-2/AC	MRC-4/AC
KUTUP SAYISI NUMBER OF POLES			2	4
NOMİNAL AKIM NOMINAL CURRENT	I_n	A	16,20, 25, 32, 40, 50, 63, 80, 100	16,20, 25, 32, 40, 50, 63, 80, 100
NOMİNAL ATIK AKIM NOMINAL RESIDUE CURRENT	I_{Δ}	mA	10, 30, 100, 300	10, 30, 100, 300
NOMİNAL FREKANS NOMINAL FREQUENCY		Hz	50-60	50-60
TİP TYPE			AC	AC
AÇMA ÜNİTESİ TRIP UNIT			ELEKTRO-MEKANİK	ELEKTRO-MEKANİK
ÇALIŞMA KARAKTERİSTİĞİ OPERATING CHARACTERISTICS			GENEL	GENEL
NOMİNAL ÇALIŞMA GERİLİMİ NOMINAL OPERATING VOLTAGE	U_e	(AC)V	230	400
NOMİNAL İZOLASYON GERİLİMİ NOMINAL INSULATION VOLTAGE	U_i	V	500	500
NOMİNAL DARBE DAYANIM GERİLİMİ NOMINAL IMPULSE WITHSTAND VOLTAGE	U_{imp}	kV	6	6
SIGORTALI NOMİNAL KISA DEVRE DAYANIM AKIMI ($I_{nc}/I_{\Delta c}$) NOMINAL FUSED SHORT CIRCUIT WITHSTAND CURRENT ($I_{nc}/I_{\Delta c}$)		kA	6	6
ELEKTRİKSEL ÖMÜR ELECTRICAL LIFE	op.	(230V)	6000	6000
MEKANİK ÖMÜR MECHANICAL LIFE	op.		20000	20000
KORUMA DERESESİ PROTECTION DEGREE			IP20	IP20
ORTAM ÇALIŞMA SICAKLIĞI AMBIENT OPERATING TEMPERATURE		°C	-25 to +60	-25 to +60
MAKS. DEPOLAMA SICAKLIĞI MAX. STORAGE TEMPERATURE		°C	-40 to +70	-40 to +70
BOYUTLAR DIMENSIONS	Genişlik Width	mm	35	70
	Uzunluk Length	mm	80	80
RENK COLOR			RAL7035	RAL7035
MONTAJ TİPİ (EN60715) MOUNTING TYPE (EN60715)			35mm DIN rayı	35mm DIN rayı
MİN.MAKS. BAĞLANTI BÖLÜMÜ MIN.MAX. CONNECTION SECTION		mm ²	2.5...25	2.5...25

KAÇAK AKIM DEVRE KORUMA RESIDUAL CURRENT CIRCUIT BREAKER (RCCB)

MRC06 SERİSİ

TEKNİK BİLGİLER TECHNICAL INFORMATION



KOD CODE	KUTUP SAYISI NO OF POLES	AÇIKLAMA DESCRIPTION	KUTU BOX	KOLİ PARCEL	KUTU AĞIRLIK BOX WEIGHT kg	KUTU HACİM BOX VOLUME m ³
MRC06-201016	2P	6KA AC 10MA 16A KAÇAK AKIM KORUMA RESIDUAL CURRENT CIRCUIT BREAKER	1	100	0,195	0,000343403
MRC06-201025	2P	6KA AC 10MA 25A KAÇAK AKIM KORUMA RESIDUAL CURRENT CIRCUIT BREAKER	1	100	0,195	0,000343403
MRC06-203016	2P	6KA AC 30MA 16A KAÇAK AKIM KORUMA RESIDUAL CURRENT CIRCUIT BREAKER	1	100	0,195	0,000343403
MRC06-203020	2P	6KA AC 30MA 20A KAÇAK AKIM KORUMA RESIDUAL CURRENT CIRCUIT BREAKER	1	100	0,195	0,000343403
MRC06-203025	2P	6KA AC 30MA 25A KAÇAK AKIM KORUMA RESIDUAL CURRENT CIRCUIT BREAKER	1	100	0,195	0,000343403
MRC06-203032	2P	6KA AC 30MA 32A KAÇAK AKIM KORUMA RESIDUAL CURRENT CIRCUIT BREAKER	1	100	0,195	0,000343403
MRC06-203040	2P	6KA AC 30MA 40A KAÇAK AKIM KORUMA RESIDUAL CURRENT CIRCUIT BREAKER	1	100	0,195	0,000343403
MRC06-203050	2P	6KA AC 30MA 50A KAÇAK AKIM KORUMA RESIDUAL CURRENT CIRCUIT BREAKER	1	100	0,215	0,000343403
MRC06-203063	2P	6KA AC 30MA 63A KAÇAK AKIM KORUMA RESIDUAL CURRENT CIRCUIT BREAKER	1	100	0,215	0,000343403
MRC06-203080	2P	6KA AC 30MA 80A KAÇAK AKIM KORUMA RESIDUAL CURRENT CIRCUIT BREAKER	1	100	0,215	0,000343403
MRC06-2030100	2P	6KA AC 30MA 100A KAÇAK AKIM KORUMA RESIDUAL CURRENT CIRCUIT BREAKER	1	100	0,215	0,000343403
MRC06-210016	2P	6KA AC 100MA 16A KAÇAK AKIM KORUMA RESIDUAL CURRENT CIRCUIT BREAKER	1	100	0,227	0,000343403
MRC06-210020	2P	6KA AC 100MA 20A KAÇAK AKIM KORUMA RESIDUAL CURRENT CIRCUIT BREAKER	1	100	0,227	0,000343403
MRC06-210025	2P	6KA AC 100MA 25A KAÇAK AKIM KORUMA RESIDUAL CURRENT CIRCUIT BREAKER	1	100	0,227	0,000343403
MRC06-210032	2P	6KA AC 100MA 32A KAÇAK AKIM KORUMA RESIDUAL CURRENT CIRCUIT BREAKER	1	100	0,227	0,000343403
MRC06-210040	2P	6KA AC 100MA 40A KAÇAK AKIM KORUMA RESIDUAL CURRENT CIRCUIT BREAKER	1	100	0,227	0,000343403
MRC06-210050	2P	6KA AC 100MA 50A KAÇAK AKIM KORUMA RESIDUAL CURRENT CIRCUIT BREAKER	1	100	0,227	0,000343403
MRC06-210063	2P	6KA AC 100MA 63A KAÇAK AKIM KORUMA RESIDUAL CURRENT CIRCUIT BREAKER	1	100	0,227	0,000343403
MRC06-210080	2P	6KA AC 100MA 80A KAÇAK AKIM KORUMA RESIDUAL CURRENT CIRCUIT BREAKER	1	100	0,227	0,000343403
MRC06-2100100	2P	6KA AC 100MA 100A KAÇAK AKIM KORUMA RESIDUAL CURRENT CIRCUIT BREAKER	1	100	0,227	0,000343403
MRC06-230016	2P	6KA AC300MA 16A KAÇAK AKIM KORUMA RESIDUAL CURRENT CIRCUIT BREAKER	1	100	0,227	0,000343403
MRC06-230020	2P	6KA AC 300MA 20A KAÇAK AKIM KORUMA RESIDUAL CURRENT CIRCUIT BREAKER	1	100	0,227	0,000343403
MRC06-230025	2P	6KA AC 300MA 25A KAÇAK AKIM KORUMA RESIDUAL CURRENT CIRCUIT BREAKER	1	100	0,227	0,000343403
MRC06-230032	2P	6KA AC 300MA 32A KAÇAK AKIM KORUMA RESIDUAL CURRENT CIRCUIT BREAKER	1	100	0,227	0,000343403
MRC06-230040	2P	6KA AC 300MA 40A KAÇAK AKIM KORUMA RESIDUAL CURRENT CIRCUIT BREAKER	1	100	0,227	0,000343403
MRC06-230050	2P	6KA AC 300MA 50A KAÇAK AKIM KORUMA RESIDUAL CURRENT CIRCUIT BREAKER	1	100	0,227	0,000343403
MRC06-230063	2P	6KA AC 300MA 63A KAÇAK AKIM KORUMA RESIDUAL CURRENT CIRCUIT BREAKER	1	100	0,227	0,000343403
MRC06-230080	2P	6KA AC 300MA 80A KAÇAK AKIM KORUMA RESIDUAL CURRENT CIRCUIT BREAKER	1	100	0,227	0,000343403
MRC06-2300100	2P	6KA AC 300MA 100A KAÇAK AKIM KORUMA RESIDUAL CURRENT CIRCUIT BREAKER	1	100	0,227	0,000343403
MRC06-403016	4P	6KA AC 30MA 16A KAÇAK AKIM KORUMA RESIDUAL CURRENT CIRCUIT BREAKER	1	50	0,227	0,000343403
MRC06-403020	4P	6KA AC 30MA 20A KAÇAK AKIM KORUMA RESIDUAL CURRENT CIRCUIT BREAKER	1	50	0,396	0,000686805
MRC06-403025	4P	6KA AC 30MA 25A KAÇAK AKIM KORUMA RESIDUAL CURRENT CIRCUIT BREAKER	1	50	0,396	0,000686805
MRC06-403032	4P	6KA AC 30MA 32A KAÇAK AKIM KORUMA RESIDUAL CURRENT CIRCUIT BREAKER	1	50	0,396	0,000686805
MRC06-403040	4P	6KA AC 30MA 40A KAÇAK AKIM KORUMA RESIDUAL CURRENT CIRCUIT BREAKER	1	50	0,396	0,000686805
MRC06-403050	4P	6KA AC 30MA 50A KAÇAK AKIM KORUMA RESIDUAL CURRENT CIRCUIT BREAKER	1	50	0,396	0,000686805
MRC06-403063	4P	6KA AC 30MA 63A KAÇAK AKIM KORUMA RESIDUAL CURRENT CIRCUIT BREAKER	1	50	0,432	0,000686805
MRC06-403080	4P	6KA AC 30MA 80A KAÇAK AKIM KORUMA RESIDUAL CURRENT CIRCUIT BREAKER	1	50	0,432	0,000686805
MRC06-4030100	4P	6KA AC 30MA 100A KAÇAK AKIM KORUMA RESIDUAL CURRENT CIRCUIT BREAKER	1	50	0,432	0,000686805
MRC06-410016	4P	6KA AC 100MA 16A KAÇAK AKIM KORUMA RESIDUAL CURRENT CIRCUIT BREAKER	1	50	0,432	0,000686805
MRC06-410020	4P	6KA AC 100MA 20A KAÇAK AKIM KORUMA RESIDUAL CURRENT CIRCUIT BREAKER	1	50	0,432	0,000686805
MRC06-410025	4P	6KA AC 100MA 25A KAÇAK AKIM KORUMA RESIDUAL CURRENT CIRCUIT BREAKER	1	50	0,432	0,000686805
MRC06-410032	4P	6KA AC 100MA 32A KAÇAK AKIM KORUMA RESIDUAL CURRENT CIRCUIT BREAKER	1	50	0,432	0,000686805
MRC06-410040	4P	6KA AC 100MA 40A KAÇAK AKIM KORUMA RESIDUAL CURRENT CIRCUIT BREAKER	1	50	0,432	0,000686805
MRC06-410050	4P	6KA AC 100MA 50A KAÇAK AKIM KORUMA RESIDUAL CURRENT CIRCUIT BREAKER	1	50	0,432	0,000686805
MRC06-410063	4P	6KA AC 100MA 63A KAÇAK AKIM KORUMA RESIDUAL CURRENT CIRCUIT BREAKER	1	50	0,432	0,000686805
MRC06-410080	4P	6KA AC 100MA 80A KAÇAK AKIM KORUMA RESIDUAL CURRENT CIRCUIT BREAKER	1	50	0,432	0,000686805
MRC06-4100100	4P	6KA AC 100MA 100A KAÇAK AKIM KORUMA RESIDUAL CURRENT CIRCUIT BREAKER	1	50	0,432	0,000686805
MRC06-430016	4P	6KA AC 300MA 16A KAÇAK AKIM KORUMA RESIDUAL CURRENT CIRCUIT BREAKER	1	50	0,373	0,000686805
MRC06-430020	4P	6KA AC 300MA 20A KAÇAK AKIM KORUMA RESIDUAL CURRENT CIRCUIT BREAKER	1	50	0,373	0,000686805
MRC06-430025	4P	6KA AC300MA 25A KAÇAK AKIM KORUMA RESIDUAL CURRENT CIRCUIT BREAKER	1	50	0,373	0,000686805
MRC06-430032	4P	6KA AC 300MA 32A KAÇAK AKIM KORUMA RESIDUAL CURRENT CIRCUIT BREAKER	1	50	0,373	0,000686805
MRC06-430040	4P	6KA AC 300MA 40A KAÇAK AKIM KORUMA RESIDUAL CURRENT CIRCUIT BREAKER	1	50	0,373	0,000686805
MRC06-430050	4P	6KA AC 300MA 50A KAÇAK AKIM KORUMA RESIDUAL CURRENT CIRCUIT BREAKER	1	50	0,373	0,000686805
MRC06-430063	4P	6KA AC 300MA 63A KAÇAK AKIM KORUMA RESIDUAL CURRENT CIRCUIT BREAKER	1	50	0,373	0,000686805
MRC06-430080	4P	6KA AC 300MA 80A KAÇAK AKIM KORUMA RESIDUAL CURRENT CIRCUIT BREAKER	1	50	0,373	0,000686805
MRC06-4300100	4P	6KA AC 300MA 100A KAÇAK AKIM KORUMA RESIDUAL CURRENT CIRCUIT BREAKER	1	50	0,373	0,000686805

SİGORTALI KAÇAK AKIM KORUMA

RESIDUAL CURRENT BREAKER with OVERCURRENT PROTECTION (RCBO)



MRC006 SERİSİ

TEKNİK BİLGİLER
TECHNICAL INFORMATION

KOD CODE	KUTUP SAYISI NO OF POLES	AÇIKLAMA DESCRIPTION	KUTU BOX	KOLİ PARCEL	KUTU AĞIRLIK BOX WEIGHT kg	KUTU HACİM BOX VOLUME m ³
MRC006-403006AC	4P	6KA AC TİPİ 30MA 6A SİGORTALI KAÇAK AKIM KORUMA	1	30	0,195	0,0007252
MRC006-403016AC	4P	6KA AC TİPİ 30MA 16A SİGORTALI KAÇAK AKIM KORUMA	1	30	0,195	0,0007252
MRC006-403020AC	4P	6KA AC TİPİ 30MA 20A SİGORTALI KAÇAK AKIM KORUMA	1	30	0,195	0,0007252
MRC006-403025AC	4P	6KA AC TİPİ 30MA 25A SİGORTALI KAÇAK AKIM KORUMA	1	30	0,195	0,0007252
MRC006-403032AC	4P	6KA AC TİPİ 30MA 32A SİGORTALI KAÇAK AKIM KORUMA	1	30	0,195	0,0007252
MRC006-403040AC	4P	6KA AC TİPİ 30MA 40A SİGORTALI KAÇAK AKIM KORUMA	1	30	0,195	0,0007252
MRC006-403063AC	4P	6KA AC TİPİ 30MA 63A SİGORTALI KAÇAK AKIM KORUMA	1	30	0,195	0,0007252
MRC006-410006AC	4P	6KA AC TİPİ 100MA 6A SİGORTALI KAÇAK AKIM KORUMA	1	30	0,195	0,0007252
MRC006-410016AC	4P	6KA AC TİPİ 100MA 16A SİGORTALI KAÇAK AKIM KORUMA	1	30	0,195	0,0007252
MRC006-410020AC	4P	6KA AC TİPİ 100MA 20A SİGORTALI KAÇAK AKIM KORUMA	1	30	0,195	0,0007252
MRC006-410025AC	4P	6KA AC TİPİ 100MA 25A SİGORTALI KAÇAK AKIM KORUMA	1	30	0,195	0,0007252
MRC006-410032AC	4P	6KA AC TİPİ 100MA 32A SİGORTALI KAÇAK AKIM KORUMA	1	30	0,195	0,0007252
MRC006-410040AC	4P	6KA AC TİPİ 100MA 40A SİGORTALI KAÇAK AKIM KORUMA	1	30	0,195	0,0007252
MRC006-410063AC	4P	6KA AC TİPİ 100MA 63A SİGORTALI KAÇAK AKIM KORUMA	1	30	0,195	0,0007252
MRC006-430006AC	4P	6KA AC TİPİ 300MA 6A SİGORTALI KAÇAK AKIM KORUMA	1	30	0,195	0,0007252
MRC006-430016AC	4P	6KA AC TİPİ 300MA 16A SİGORTALI KAÇAK AKIM KORUMA	1	30	0,195	0,0007252
MRC006-430020AC	4P	6KA AC TİPİ 300MA 20A SİGORTALI KAÇAK AKIM KORUMA	1	30	0,195	0,0007252
MRC006-430025AC	4P	6KA AC TİPİ 300MA 25A SİGORTALI KAÇAK AKIM KORUMA	1	30	0,195	0,0007252
MRC006-430032AC	4P	6KA AC TİPİ 300MA 32A SİGORTALI KAÇAK AKIM KORUMA	1	30	0,195	0,0007252
MRC006-430040AC	4P	6KA AC TİPİ 300MA 40A SİGORTALI KAÇAK AKIM KORUMA	1	30	0,195	0,0007252
MRC006-430063AC	4P	6KA AC TİPİ 300MA 63A SİGORTALI KAÇAK AKIM KORUMA	1	30	0,195	0,0007252
MRC006-403006A	4P	6KA A TİPİ 30MA 6A SİGORTALI KAÇAK AKIM KORUMA	1	30	0,195	0,0007252
MRC006-403016A	4P	6KA A TİPİ 30MA 16A SİGORTALI KAÇAK AKIM KORUMA	1	30	0,195	0,0007252
MRC006-403020A	4P	6KA A TİPİ 30MA 20A SİGORTALI KAÇAK AKIM KORUMA	1	30	0,195	0,0007252
MRC006-403025A	4P	6KA A TİPİ 30MA 25A SİGORTALI KAÇAK AKIM KORUMA	1	30	0,195	0,0007252
MRC006-403032A	4P	6KA A TİPİ 30MA 32A SİGORTALI KAÇAK AKIM KORUMA	1	30	0,195	0,0007252
MRC006-403040A	4P	6KA A TİPİ 30MA 40A SİGORTALI KAÇAK AKIM KORUMA	1	30	0,195	0,0007252
MRC006-403063A	4P	6KA A TİPİ 30MA 63A SİGORTALI KAÇAK AKIM KORUMA	1	30	0,195	0,0007252
MRC006-410006A	4P	6KA A TİPİ 100MA 6A SİGORTALI KAÇAK AKIM KORUMA	1	30	0,195	0,0007252
MRC006-410016A	4P	6KA A TİPİ 100MA 16A SİGORTALI KAÇAK AKIM KORUMA	1	30	0,195	0,0007252
MRC006-410020A	4P	6KA A TİPİ 100MA 20A SİGORTALI KAÇAK AKIM KORUMA	1	30	0,195	0,0007252
MRC006-410025A	4P	6KA A TİPİ 100MA 25A SİGORTALI KAÇAK AKIM KORUMA	1	30	0,195	0,0007252
MRC006-410032A	4P	6KA A TİPİ 100MA 32A SİGORTALI KAÇAK AKIM KORUMA	1	30	0,195	0,0007252
MRC006-410040A	4P	6KA A TİPİ 100MA 40A SİGORTALI KAÇAK AKIM KORUMA	1	30	0,195	0,0007252
MRC006-410063A	4P	6KA A TİPİ 100MA 63A SİGORTALI KAÇAK AKIM KORUMA	1	30	0,195	0,0007252
MRC006-430006A	4P	6KA A TİPİ 300MA 6A SİGORTALI KAÇAK AKIM KORUMA	1	30	0,195	0,0007252
MRC006-430016A	4P	6KA A TİPİ 300MA 16A SİGORTALI KAÇAK AKIM KORUMA	1	30	0,195	0,0007252
MRC006-430020A	4P	6KA A TİPİ 300MA 20A SİGORTALI KAÇAK AKIM KORUMA	1	30	0,195	0,0007252
MRC006-430025A	4P	6KA A TİPİ 300MA 25A SİGORTALI KAÇAK AKIM KORUMA	1	30	0,195	0,0007252
MRC006-430032A	4P	6KA A TİPİ 300MA 32A SİGORTALI KAÇAK AKIM KORUMA	1	30	0,195	0,0007252
MRC006-430040A	4P	6KA A TİPİ 300MA 40A SİGORTALI KAÇAK AKIM KORUMA	1	30	0,195	0,0007252
MRC006-430063A	4P	6KA A TİPİ 300MA 63A SİGORTALI KAÇAK AKIM KORUMA	1	30	0,195	0,0007252

TERMİK MANYETİK ŞALTER (TMS)

MOLDED CASE CIRCUIT BREAKER (MCCB)

YENİ
NEW

Sabit Tip
Fixed Type

Ayar Sahalı
Adjustable Type

Kaçak
Akım Korumalı
Leakage Type



Devre açma ve kapama yapan termik manyetik şalterler sabit, ayar sahalı ve kaçak akım korumalı olmak üzere 18kA-50kA aralığında ve 16A'den 800A'e kadar geniş Amper seçeneğiyle.

Thermal magnetic switches (MCCB) that open and close circuits are available with fixed, adjustable, and residual current protection, offering a wide range of Ampere options from 16A to 800A and short-circuit ratings between 18kA-50kA.

16 ile 800 amper arasında akım değerlerini destekleyerek çeşitli elektrik devreleri için çok yönlü koruma sağlar.

Farklı yük koşulları için optimum performans sağlamak amacıyla aşırı yük korumasının hassas şekilde özelleştirilmesine olanak tanır.

Hem termal hem de manyetik açma üniteleriyle donatılmıştır, aşırı yük ve kısa devrelere karşı kapsamlı koruma sağlar.

Zorlu ortamlara dayanacak şekilde sağlam malzemelerle üretilmiş olup, uzun servis ömrü ve sürekli performans sunar.

Designed to handle current ratings from 16 to 800 amps, providing versatile protection for various electrical circuits.

Allows precise customization of overload protection, ensuring optimal performance for different load conditions.

Equipped with both thermal and magnetic trip units, offering comprehensive protection against overloads and short circuits.

Built with robust materials to withstand harsh environments, ensuring long service life and consistent performance.

TERMİK MANYETİK ŞALTER (TMŞ)

SABİT TİP

MOLDED CASE CIRCUIT BREAKER (MCCB)

FIXED TYPE

MTF SERİSİ

TEKNİK BİLGİLER

TECHNICAL INFORMATION



KOD CODE	KUTUP SAYISI POLES	AÇIKLAMA DESCRIPTION	KUTU BOX	KOLİ PARCEL	KUTU AĞIRLIK BOX WEIGHT kg	KUTU HACİM BOX VOLUME m3
MTF18-2040	2P	18KA 40A TERMİK MANYETİK ŞALTER MOLDED CASE CIRCUIT BREAKER FIXED TYPE	1	36	0,547	0,00086275
MTF18-2063	2P	18KA 63A TERMİK MANYETİK ŞALTER MOLDED CASE CIRCUIT BREAKER FIXED TYPE	1	36	0,611	0,00086275
MTF18-2100	2P	18KA 100A TERMİK MANYETİK ŞALTER MOLDED CASE CIRCUIT BREAKER FIXED TYPE	1	36	0,611	0,00086275
MTF18-2125	2P	18KA 125A TERMİK MANYETİK ŞALTER MOLDED CASE CIRCUIT BREAKER FIXED TYPE	1	36	0,611	0,00086275
MTF18-2160	2P	18KA 160A TERMİK MANYETİK ŞALTER MOLDED CASE CIRCUIT BREAKER FIXED TYPE	1	36	0,611	0,00086275
MTF22-3016	3P	22KA 16A TERMİK MANYETİK ŞALTER MOLDED CASE CIRCUIT BREAKER FIXED TYPE	1	24	0,829	0,001294125
MTF22-3040	3P	22KA 40A TERMİK MANYETİK ŞALTER MOLDED CASE CIRCUIT BREAKER FIXED TYPE	1	24	0,829	0,001294125
MTF22-3063	3P	22KA 63A TERMİK MANYETİK ŞALTER MOLDED CASE CIRCUIT BREAKER FIXED TYPE	1	24	0,942	0,001294125
MTF22-3100	3P	22KA 100A TERMİK MANYETİK ŞALTER MOLDED CASE CIRCUIT BREAKER FIXED TYPE	1	24	0,942	0,001294125
MTF22-3125	3P	22KA 125A TERMİK MANYETİK ŞALTER MOLDED CASE CIRCUIT BREAKER FIXED TYPE	1	24	0,942	0,001294125
MTF22-3160	3P	22KA 160A TERMİK MANYETİK ŞALTER MOLDED CASE CIRCUIT BREAKER FIXED TYPE	1	24	0,942	0,001294125
MTF25-3016	3P	25KA 16A TERMİK MANYETİK ŞALTER MOLDED CASE CIRCUIT BREAKER FIXED TYPE	1	24	0,829	0,001294125
MTF25-3025	3P	25KA 25A TERMİK MANYETİK ŞALTER MOLDED CASE CIRCUIT BREAKER FIXED TYPE	1	24	0,829	0,001294125
MTF25-3032	3P	25KA 32A TERMİK MANYETİK ŞALTER MOLDED CASE CIRCUIT BREAKER FIXED TYPE	1	24	0,829	0,001294125
MTF25-3040	3P	25KA 40A TERMİK MANYETİK ŞALTER MOLDED CASE CIRCUIT BREAKER FIXED TYPE	1	24	0,829	0,001294125
MTF25-3050	3P	25KA 50A TERMİK MANYETİK ŞALTER MOLDED CASE CIRCUIT BREAKER FIXED TYPE	1	24	0,829	0,001294125
MTF25-3063	3P	25KA 63A TERMİK MANYETİK ŞALTER MOLDED CASE CIRCUIT BREAKER FIXED TYPE	1	24	0,942	0,001294125
MTF25-3080	3P	25KA 80A TERMİK MANYETİK ŞALTER MOLDED CASE CIRCUIT BREAKER FIXED TYPE	1	24	0,942	0,001294125
MTF25-3100	3P	25KA 100A TERMİK MANYETİK ŞALTER MOLDED CASE CIRCUIT BREAKER FIXED TYPE	1	24	0,942	0,001294125
MTF25-3125	3P	25KA 125A TERMİK MANYETİK ŞALTER MOLDED CASE CIRCUIT BREAKER FIXED TYPE	1	24	0,942	0,001294125
MTF25-3160	3P	25KA 160A TERMİK MANYETİK ŞALTER MOLDED CASE CIRCUIT BREAKER FIXED TYPE	1	24	0,942	0,001294125
MTF35-3100	3P	35KA 100A TERMİK MANYETİK ŞALTER MOLDED CASE CIRCUIT BREAKER FIXED TYPE	1	16	1,25	0,002724125
MTF35-3125	3P	35KA 125A TERMİK MANYETİK ŞALTER MOLDED CASE CIRCUIT BREAKER FIXED TYPE	1	16	1,25	0,002724125
MTF35-3160	3P	35KA 160A TERMİK MANYETİK ŞALTER MOLDED CASE CIRCUIT BREAKER FIXED TYPE	1	16	1,25	0,002724125
MTF35-3200	3P	35KA 200A TERMİK MANYETİK ŞALTER MOLDED CASE CIRCUIT BREAKER FIXED TYPE	1	16	1,25	0,002724125
MTF35-3250	3P	35KA 250A TERMİK MANYETİK ŞALTER MOLDED CASE CIRCUIT BREAKER FIXED TYPE	1	16	1,25	0,002724125
MTF42-3100	3P	42KA 100A TERMİK MANYETİK ŞALTER MOLDED CASE CIRCUIT BREAKER FIXED TYPE	1	16	1,25	0,002724125
MTF42-3125	3P	42KA 125A TERMİK MANYETİK ŞALTER MOLDED CASE CIRCUIT BREAKER FIXED TYPE	1	16	1,25	0,002724125
MTF42-3160	3P	42KA 160A TERMİK MANYETİK ŞALTER MOLDED CASE CIRCUIT BREAKER FIXED TYPE	1	16	1,25	0,002724125
MTF42-3200	3P	42KA 200A TERMİK MANYETİK ŞALTER MOLDED CASE CIRCUIT BREAKER FIXED TYPE	1	16	1,25	0,002724125
MTF42-3250	3P	42KA 250A TERMİK MANYETİK ŞALTER MOLDED CASE CIRCUIT BREAKER FIXED TYPE	1	16	1,25	0,002724125
MTF50-30315	3P	50KA 315A TERMİK MANYETİK ŞALTER MOLDED CASE CIRCUIT BREAKER FIXED TYPE	1	12	1,917	0,003131333
MTF50-30400	3P	50KA 400A TERMİK MANYETİK ŞALTER MOLDED CASE CIRCUIT BREAKER FIXED TYPE	1	12	1,917	0,003131333
MTF50-30500	3P	50KA 500A TERMİK MANYETİK ŞALTER MOLDED CASE CIRCUIT BREAKER FIXED TYPE	1	12	1,917	0,003131333
MTF50-30630	3P	50KA 630A TERMİK MANYETİK ŞALTER MOLDED CASE CIRCUIT BREAKER FIXED TYPE	1	12	1,917	0,003131333
MTF50-30800	3P	50KA 800A TERMİK MANYETİK ŞALTER MOLDED CASE CIRCUIT BREAKER FIXED TYPE	1	12	1,917	0,003131333
MTF22-4016	4P	22KA 16A TERMİK MANYETİK ŞALTER MOLDED CASE CIRCUIT BREAKER FIXED TYPE	1	18	1,033	0,0017255
MTF22-4040	4P	22KA 40A TERMİK MANYETİK ŞALTER MOLDED CASE CIRCUIT BREAKER FIXED TYPE	1	18	1,033	0,0017255
MTF22-4063	4P	22KA 63A TERMİK MANYETİK ŞALTER MOLDED CASE CIRCUIT BREAKER FIXED TYPE	1	18	1,183	0,0017255
MTF22-4100	4P	22KA 100A TERMİK MANYETİK ŞALTER MOLDED CASE CIRCUIT BREAKER FIXED TYPE	1	18	1,183	0,0017255
MTF22-4125	4P	22KA 125A TERMİK MANYETİK ŞALTER MOLDED CASE CIRCUIT BREAKER FIXED TYPE	1	18	1,183	0,0017255
MTF22-4160	4P	22KA 160A TERMİK MANYETİK ŞALTER MOLDED CASE CIRCUIT BREAKER FIXED TYPE	1	18	1,183	0,0017255
MTF25-4016	4P	25KA 16A TERMİK MANYETİK ŞALTER MOLDED CASE CIRCUIT BREAKER FIXED TYPE	1	18	1,033	0,0017255
MTF25-4025	4P	25KA 25A TERMİK MANYETİK ŞALTER MOLDED CASE CIRCUIT BREAKER FIXED TYPE	1	18	1,033	0,0017255
MTF25-4032	4P	25KA 32A TERMİK MANYETİK ŞALTER MOLDED CASE CIRCUIT BREAKER FIXED TYPE	1	18	1,033	0,0017255
MTF25-4040	4P	25KA 40A TERMİK MANYETİK ŞALTER MOLDED CASE CIRCUIT BREAKER FIXED TYPE	1	18	1,033	0,0017255
MTF25-4063	4P	25KA 63A TERMİK MANYETİK ŞALTER MOLDED CASE CIRCUIT BREAKER FIXED TYPE	1	18	1,183	0,0017255
MTF25-4080	4P	25KA 80A TERMİK MANYETİK ŞALTER MOLDED CASE CIRCUIT BREAKER FIXED TYPE	1	18	1,183	0,0017255
MTF25-4100	4P	25KA 100A TERMİK MANYETİK ŞALTER MOLDED CASE CIRCUIT BREAKER FIXED TYPE	1	18	1,183	0,0017255
MTF25-4125	4P	25KA 125A TERMİK MANYETİK ŞALTER MOLDED CASE CIRCUIT BREAKER FIXED TYPE	1	18	1,183	0,0017255
MTF25-4160	4P	25KA 160A TERMİK MANYETİK ŞALTER MOLDED CASE CIRCUIT BREAKER FIXED TYPE	1	18	1,183	0,0017255
MTF35-4100	4P	35KA 100A TERMİK MANYETİK ŞALTER MOLDED CASE CIRCUIT BREAKER FIXED TYPE	1	12	1,917	0,003131333
MTF35-4125	4P	35KA 125A TERMİK MANYETİK ŞALTER MOLDED CASE CIRCUIT BREAKER FIXED TYPE	1	12	1,917	0,003131333
MTF35-4160	4P	35KA 160A TERMİK MANYETİK ŞALTER MOLDED CASE CIRCUIT BREAKER FIXED TYPE	1	12	1,917	0,003131333
MTF35-4200	4P	35KA 200A TERMİK MANYETİK ŞALTER MOLDED CASE CIRCUIT BREAKER FIXED TYPE	1	12	1,917	0,003131333
MTF35-4250	4P	35KA 250A TERMİK MANYETİK ŞALTER MOLDED CASE CIRCUIT BREAKER FIXED TYPE	1	12	1,917	0,003131333
MTF42-4100	4P	42KA 100A TERMİK MANYETİK ŞALTER MOLDED CASE CIRCUIT BREAKER FIXED TYPE	1	12	1,917	0,003131333
MTF42-4125	4P	42KA 125A TERMİK MANYETİK ŞALTER MOLDED CASE CIRCUIT BREAKER FIXED TYPE	1	12	1,917	0,003131333
MTF42-4160	4P	42KA 160A TERMİK MANYETİK ŞALTER MOLDED CASE CIRCUIT BREAKER FIXED TYPE	1	12	1,917	0,003131333
MTF42-4200	4P	42KA 200A TERMİK MANYETİK ŞALTER MOLDED CASE CIRCUIT BREAKER FIXED TYPE	1	12	1,917	0,003131333
MTF42-4250	4P	42KA 250A TERMİK MANYETİK ŞALTER MOLDED CASE CIRCUIT BREAKER FIXED TYPE	1	12	1,917	0,003131333
MTF50-40315	4P	50KA 315A TERMİK MANYETİK ŞALTER MOLDED CASE CIRCUIT BREAKER FIXED TYPE	1	12	1,917	0,003131333
MTF50-40400	4P	50KA 400A TERMİK MANYETİK ŞALTER MOLDED CASE CIRCUIT BREAKER FIXED TYPE	1	12	1,917	0,003131333
MTF50-40500	4P	50KA 500A TERMİK MANYETİK ŞALTER MOLDED CASE CIRCUIT BREAKER FIXED TYPE	1	12	1,917	0,003131333
MTF50-40630	4P	50KA 630A TERMİK MANYETİK ŞALTER MOLDED CASE CIRCUIT BREAKER FIXED TYPE	1	12	1,917	0,003131333
MTF50-40800	4P	50KA 800A TERMİK MANYETİK ŞALTER MOLDED CASE CIRCUIT BREAKER FIXED TYPE	1	12	1,917	0,003131333

TERMİK MANYETİK ŞALTER (TMŞ)

AYAR SAHALI TİP

MOLDED CASE CIRCUIT BREAKER (MCCB)
ADJUSTABLE TYPE



MTA SERİSİ

TEKNİK BİLGİLER

TECHNICAL INFORMATION

KOD CODE	KUTUP SAYISI POLES	AÇIKLAMA DESCRIPTION	TERMİK AYAR SAHASI (A) THERMAL ADJUSTMENT RANGE	KUTU BOX	KOLİ PARCEL	KUTU AĞIRLIK BOX WEIGHT kg	KUTU HACİM BOX VOLUME m3
MTA18-2040	2P	18KA 40A TERMİK MANYETİK ŞALTER MOLDED CASE CIRCUIT BREAKER ADJUSTABLE TYPE	32-40	1	36	0,547	0,00086275
MTA18-2063	2P	18KA 63A TERMİK MANYETİK ŞALTER MOLDED CASE CIRCUIT BREAKER ADJUSTABLE TYPE	50-63	1	36	0,611	0,00086275
MTA18-2100	2P	18KA 100A TERMİK MANYETİK ŞALTER MOLDED CASE CIRCUIT BREAKER ADJUSTABLE TYPE	80-100	1	36	0,611	0,00086275
MTA18-2125	2P	18KA 125A TERMİK MANYETİK ŞALTER MOLDED CASE CIRCUIT BREAKER ADJUSTABLE TYPE	100-125	1	36	0,611	0,00086275
MTA18-2160	2P	18KA 160A TERMİK MANYETİK ŞALTER MOLDED CASE CIRCUIT BREAKER ADJUSTABLE TYPE	125-160	1	36	0,611	0,00086275
MTA22-3016	3P	22KA 16A TERMİK MANYETİK ŞALTER MOLDED CASE CIRCUIT BREAKER ADJUSTABLE TYPE	12-16	1	24	0,829	0,001294125
MTA22-3040	3P	22KA 40A TERMİK MANYETİK ŞALTER MOLDED CASE CIRCUIT BREAKER ADJUSTABLE TYPE	32-40	1	24	0,829	0,001294125
MTA22-3063	3P	22KA 63A TERMİK MANYETİK ŞALTER MOLDED CASE CIRCUIT BREAKER ADJUSTABLE TYPE	50-63	1	24	0,942	0,001294125
MTA22-3100	3P	22KA 100A TERMİK MANYETİK ŞALTER MOLDED CASE CIRCUIT BREAKER ADJUSTABLE TYPE	80-100	1	24	0,942	0,001294125
MTA22-3125	3P	22KA 125A TERMİK MANYETİK ŞALTER MOLDED CASE CIRCUIT BREAKER ADJUSTABLE TYPE	100-125	1	24	0,942	0,001294125
MTA22-3160	3P	22KA 160A TERMİK MANYETİK ŞALTER MOLDED CASE CIRCUIT BREAKER ADJUSTABLE TYPE	125-160	1	24	0,942	0,001294125
MTA25-3016	3P	25KA 16A TERMİK MANYETİK ŞALTER MOLDED CASE CIRCUIT BREAKER ADJUSTABLE TYPE	12-16	1	24	0,82917	0,001294125
MTA25-3025	3P	25KA 25A TERMİK MANYETİK ŞALTER MOLDED CASE CIRCUIT BREAKER ADJUSTABLE TYPE	16-25	1	24	0,829	0,001294125
MTA25-3032	3P	25KA 32A TERMİK MANYETİK ŞALTER MOLDED CASE CIRCUIT BREAKER ADJUSTABLE TYPE	25-32	1	24	0,829	0,001294125
MTA25-3040	3P	25KA 40A TERMİK MANYETİK ŞALTER MOLDED CASE CIRCUIT BREAKER ADJUSTABLE TYPE	32-40	1	24	0,829	0,001294125
MTA25-3050	3P	25KA 50A TERMİK MANYETİK ŞALTER MOLDED CASE CIRCUIT BREAKER ADJUSTABLE TYPE	40-50	1	24	0,829	0,001294125
MTA25-3063	3P	25KA 63A TERMİK MANYETİK ŞALTER MOLDED CASE CIRCUIT BREAKER ADJUSTABLE TYPE	50-63	1	24	0,94167	0,001294125
MTA25-3080	3P	25KA 80A TERMİK MANYETİK ŞALTER MOLDED CASE CIRCUIT BREAKER ADJUSTABLE TYPE	63-80	1	24	0,942	0,001294125
MTA25-3100	3P	25KA 100A TERMİK MANYETİK ŞALTER MOLDED CASE CIRCUIT BREAKER ADJUSTABLE TYPE	80-100	1	24	0,942	0,001294125
MTA25-3125	3P	25KA 125A TERMİK MANYETİK ŞALTER MOLDED CASE CIRCUIT BREAKER ADJUSTABLE TYPE	100-125	1	24	0,942	0,001294125
MTA25-3160	3P	25KA 160A TERMİK MANYETİK ŞALTER MOLDED CASE CIRCUIT BREAKER ADJUSTABLE TYPE	125-160	1	24	0,942	0,001294125
MTA35-3100	3P	35KA 100A TERMİK MANYETİK ŞALTER MOLDED CASE CIRCUIT BREAKER ADJUSTABLE TYPE	80-100	1	16	1,25	0,002724125
MTA35-3125	3P	35KA 125A TERMİK MANYETİK ŞALTER MOLDED CASE CIRCUIT BREAKER ADJUSTABLE TYPE	100-125	1	16	1,25	0,002724125
MTA35-3160	3P	35KA 160A TERMİK MANYETİK ŞALTER MOLDED CASE CIRCUIT BREAKER ADJUSTABLE TYPE	125-160	1	16	1,25	0,002724125
MTA35-3200	3P	35KA 200A TERMİK MANYETİK ŞALTER MOLDED CASE CIRCUIT BREAKER ADJUSTABLE TYPE	160-200	1	16	1,25	0,002724125
MTA35-3250	3P	35KA 250A TERMİK MANYETİK ŞALTER MOLDED CASE CIRCUIT BREAKER ADJUSTABLE TYPE	200-250	1	16	1,25	0,002724125
MTA42-3100	3P	42KA 100A TERMİK MANYETİK ŞALTER MOLDED CASE CIRCUIT BREAKER ADJUSTABLE TYPE	80-100	1	16	1,25	0,002724125
MTA42-3125	3P	42KA 125A TERMİK MANYETİK ŞALTER MOLDED CASE CIRCUIT BREAKER ADJUSTABLE TYPE	100-125	1	16	1,25	0,002724125
MTA42-3160	3P	42KA 160A TERMİK MANYETİK ŞALTER MOLDED CASE CIRCUIT BREAKER ADJUSTABLE TYPE	125-160	1	16	1,25	0,002724125
MTA42-3200	3P	42KA 200A TERMİK MANYETİK ŞALTER MOLDED CASE CIRCUIT BREAKER ADJUSTABLE TYPE	160-200	1	16	1,25	0,002724125
MTA42-3250	3P	42KA 250A TERMİK MANYETİK ŞALTER MOLDED CASE CIRCUIT BREAKER ADJUSTABLE TYPE	200-250	1	16	1,25	0,002724125
MTA50-30315	3P	50KA 315A TERMİK MANYETİK ŞALTER MOLDED CASE CIRCUIT BREAKER ADJUSTABLE TYPE	250-315	1	4	5,726	0,014112866
MTA50-30400	3P	50KA 400A TERMİK MANYETİK ŞALTER MOLDED CASE CIRCUIT BREAKER ADJUSTABLE TYPE	315-400	1	4	5,726	0,014112866
MTA50-30630	3P	50KA 630A TERMİK MANYETİK ŞALTER MOLDED CASE CIRCUIT BREAKER ADJUSTABLE TYPE	500-630	1	2	7,571	0,016883285
MTA50-30800	3P	50KA 800A TERMİK MANYETİK ŞALTER MOLDED CASE CIRCUIT BREAKER ADJUSTABLE TYPE	630-800	1	2	8,877	0,0185024
MTA22-4016	4P	22KA 16A TERMİK MANYETİK ŞALTER MOLDED CASE CIRCUIT BREAKER ADJUSTABLE TYPE	12-16	1	18	1,033	0,0017255
MTA22-4040	4P	22KA 40A TERMİK MANYETİK ŞALTER MOLDED CASE CIRCUIT BREAKER ADJUSTABLE TYPE	32-40	1	18	1,033	0,0017255
MTA22-4063	4P	22KA 63A TERMİK MANYETİK ŞALTER MOLDED CASE CIRCUIT BREAKER ADJUSTABLE TYPE	50-63	1	18	1,183	0,0017255
MTA22-4100	4P	22KA 100A TERMİK MANYETİK ŞALTER MOLDED CASE CIRCUIT BREAKER ADJUSTABLE TYPE	80-100	1	18	1,183	0,0017255
MTA22-4125	4P	22KA 125A TERMİK MANYETİK ŞALTER MOLDED CASE CIRCUIT BREAKER ADJUSTABLE TYPE	100-125	1	18	1,183	0,0017255
MTA22-4160	4P	22KA 160A TERMİK MANYETİK ŞALTER MOLDED CASE CIRCUIT BREAKER ADJUSTABLE TYPE	125-160	1	18	1,18333	0,0017255
MTA25-4016	4P	25KA 16A TERMİK MANYETİK ŞALTER MOLDED CASE CIRCUIT BREAKER ADJUSTABLE TYPE	12-16	1	18	1,03333	0,0017255
MTA25-4025	4P	25KA 25A TERMİK MANYETİK ŞALTER MOLDED CASE CIRCUIT BREAKER ADJUSTABLE TYPE	16-25	1	18	1,033	0,0017255
MTA25-4032	4P	25KA 32A TERMİK MANYETİK ŞALTER MOLDED CASE CIRCUIT BREAKER ADJUSTABLE TYPE	25-32	1	18	1,033	0,0017255
MTA25-4040	4P	25KA 40A TERMİK MANYETİK ŞALTER MOLDED CASE CIRCUIT BREAKER ADJUSTABLE TYPE	32-40	1	18	1,03333	0,0017255
MTA25-4063	4P	25KA 63A TERMİK MANYETİK ŞALTER MOLDED CASE CIRCUIT BREAKER ADJUSTABLE TYPE	50-63	1	18	1,18333	0,0017255
MTA25-4080	4P	25KA 80A TERMİK MANYETİK ŞALTER MOLDED CASE CIRCUIT BREAKER ADJUSTABLE TYPE	63-80	1	18	1,183	0,0017255
MTA25-4100	4P	25KA 100A TERMİK MANYETİK ŞALTER MOLDED CASE CIRCUIT BREAKER ADJUSTABLE TYPE	80-100	1	18	1,18333	0,0017255
MTA25-4125	4P	25KA 125A TERMİK MANYETİK ŞALTER MOLDED CASE CIRCUIT BREAKER ADJUSTABLE TYPE	100-125	1	18	1,18333	0,0017255
MTA25-4160	4P	25KA 160A TERMİK MANYETİK ŞALTER MOLDED CASE CIRCUIT BREAKER ADJUSTABLE TYPE	125-160	1	18	1,18333	0,0017255
MTA35-4100	4P	35KA 100A TERMİK MANYETİK ŞALTER MOLDED CASE CIRCUIT BREAKER ADJUSTABLE TYPE	80-100	1	12	1,91667	0,003131333
MTA35-4125	4P	35KA 125A TERMİK MANYETİK ŞALTER MOLDED CASE CIRCUIT BREAKER ADJUSTABLE TYPE	100-125	1	12	1,91667	0,003131333
MTA35-4160	4P	35KA 160A TERMİK MANYETİK ŞALTER MOLDED CASE CIRCUIT BREAKER ADJUSTABLE TYPE	125-160	1	12	1,91667	0,003131333
MTA35-4200	4P	35KA 200A TERMİK MANYETİK ŞALTER MOLDED CASE CIRCUIT BREAKER ADJUSTABLE TYPE	160-200	1	12	1,91667	0,003131333
MTA35-4250	4P	35KA 250A TERMİK MANYETİK ŞALTER MOLDED CASE CIRCUIT BREAKER ADJUSTABLE TYPE	200-250	1	12	1,91667	0,003131333
MTA42-4100	4P	42KA 100A TERMİK MANYETİK ŞALTER MOLDED CASE CIRCUIT BREAKER ADJUSTABLE TYPE	80-100	1	12	1,91667	0,003131333
MTA42-4125	4P	42KA 125A TERMİK MANYETİK ŞALTER MOLDED CASE CIRCUIT BREAKER ADJUSTABLE TYPE	100-125	1	12	1,91667	0,003131333
MTA42-4160	4P	42KA 160A TERMİK MANYETİK ŞALTER MOLDED CASE CIRCUIT BREAKER ADJUSTABLE TYPE	125-160	1	12	1,91667	0,003131333
MTA42-4200	4P	42KA 200A TERMİK MANYETİK ŞALTER MOLDED CASE CIRCUIT BREAKER ADJUSTABLE TYPE	160-200	1	12	1,91667	0,003131333
MTA42-4250	4P	42KA 250A TERMİK MANYETİK ŞALTER MOLDED CASE CIRCUIT BREAKER ADJUSTABLE TYPE	200-250	1	12	1,91667	0,003131333
MTA50-40315	4P	50KA 315A TERMİK MANYETİK ŞALTER MOLDED CASE CIRCUIT BREAKER ADJUSTABLE TYPE	250-315	1	3	7,325	0,015143333
MTA50-40400	4P	50KA 400A TERMİK MANYETİK ŞALTER MOLDED CASE CIRCUIT BREAKER ADJUSTABLE TYPE	315-400	1	3	7,325	0,015143333
MTA50-40630	4P	50KA 630A TERMİK MANYETİK ŞALTER MOLDED CASE CIRCUIT BREAKER ADJUSTABLE TYPE	500-630	1	2	9,766	0,0185888
MTA50-40800	4P	50KA 800A TERMİK MANYETİK ŞALTER MOLDED CASE CIRCUIT BREAKER ADJUSTABLE TYPE	630-800	1	2	11,394	0,0232064

TERMİK MANYETİK ŞALTER (TMŞ)
KAÇAK AKIM KORUMALI TİP
 MOLDED CASE CIRCUIT BREAKER (MCCB)
 LEAKAGE TYPE



MTL SERİSİ

TEKNİK BİLGİLER
 TECHNICAL INFORMATION

KOD CODE	KUTUP SAYISI POLES	AÇIKLAMA DESCRIPTION	KAPASİTE TERMAL ADJUSTMENT RANGE (mA)	KUTU BOX	KOLİ PARCEL	KUTU AĞIRLIK BOX WEIGHT kg	KUTU HACİM BOX VOLUME m3
MTL18-2025	2P	18KA 25A TERMİK MANYETİK ŞALTER MOLDED CASE CIRCUIT BREAKER LEAKAGE TYPE	30-300-500	1	36	0,547	0,00086275
MTL18-2040	2P	18KA 40A TERMİK MANYETİK ŞALTER MOLDED CASE CIRCUIT BREAKER LEAKAGE TYPE	30-300-500	1	36	0,54722	0,00086275
MTL18-2063	2P	18KA 63A TERMİK MANYETİK ŞALTER MOLDED CASE CIRCUIT BREAKER LEAKAGE TYPE	30-300-500	1	36	0,61111	0,00086275
MTL18-2100	2P	18KA 100A TERMİK MANYETİK ŞALTER MOLDED CASE CIRCUIT BREAKER LEAKAGE TYPE	30-300-500	1	36	0,61111	0,00086275
MTL18-2125	2P	18KA 125A TERMİK MANYETİK ŞALTER MOLDED CASE CIRCUIT BREAKER LEAKAGE TYPE	30-300-500	1	36	0,61111	0,00086275
MTL22-3016	3P	22KA 16A TERMİK MANYETİK ŞALTER MOLDED CASE CIRCUIT BREAKER LEAKAGE TYPE	30-300-500	1	20	1	0,0026676
MTL22-3040	3P	22KA 40A TERMİK MANYETİK ŞALTER MOLDED CASE CIRCUIT BREAKER LEAKAGE TYPE	30-300-500	1	20	1	0,0026676
MTL22-3063	3P	22KA 63A TERMİK MANYETİK ŞALTER MOLDED CASE CIRCUIT BREAKER LEAKAGE TYPE	30-300-500	1	20	1	0,0026676
MTL22-3100	3P	22KA 100A TERMİK MANYETİK ŞALTER MOLDED CASE CIRCUIT BREAKER LEAKAGE TYPE	30-300-500	1	20	1	0,0026676
MTL22-3125	3P	22KA 125A TERMİK MANYETİK ŞALTER MOLDED CASE CIRCUIT BREAKER LEAKAGE TYPE	30-300-500	1	20	1	0,0026676
MTL25-3016	3P	25KA 16A TERMİK MANYETİK ŞALTER MOLDED CASE CIRCUIT BREAKER LEAKAGE TYPE	30-300-500	1	20	1	0,0026676
MTL25-3025	3P	25KA 25A TERMİK MANYETİK ŞALTER MOLDED CASE CIRCUIT BREAKER LEAKAGE TYPE	30-300-500	1	20	1	0,0026676
MTL25-3032	3P	25KA 32A TERMİK MANYETİK ŞALTER MOLDED CASE CIRCUIT BREAKER LEAKAGE TYPE	30-300-500	1	20	1	0,0026676
MTL25-3040	3P	25KA 40A TERMİK MANYETİK ŞALTER MOLDED CASE CIRCUIT BREAKER LEAKAGE TYPE	30-300-500	1	20	1	0,0026676
MTL25-3050	3P	25KA 50A TERMİK MANYETİK ŞALTER MOLDED CASE CIRCUIT BREAKER LEAKAGE TYPE	30-300-500	1	20	1	0,0026676
MTL25-3063	3P	25KA 63A TERMİK MANYETİK ŞALTER MOLDED CASE CIRCUIT BREAKER LEAKAGE TYPE	30-300-500	1	20	1	0,0026676
MTL25-3080	3P	25KA 80A TERMİK MANYETİK ŞALTER MOLDED CASE CIRCUIT BREAKER LEAKAGE TYPE	30-300-500	1	20	1	0,0026676
MTL25-3100	3P	25KA 100A TERMİK MANYETİK ŞALTER MOLDED CASE CIRCUIT BREAKER LEAKAGE TYPE	30-300-500	1	20	1	0,0026676
MTL25-3125	3P	25KA 125A TERMİK MANYETİK ŞALTER MOLDED CASE CIRCUIT BREAKER LEAKAGE TYPE	30-300-500	1	20	1	0,0026676
MTL35-3100	3P	35KA 100A TERMİK MANYETİK ŞALTER MOLDED CASE CIRCUIT BREAKER LEAKAGE TYPE	30-300-500	1	10	1,73	0,0042809
MTL35-3125	3P	35KA 125A TERMİK MANYETİK ŞALTER MOLDED CASE CIRCUIT BREAKER LEAKAGE TYPE	30-300-500	1	10	1,73	0,0042809
MTL35-3160	3P	35KA 160A TERMİK MANYETİK ŞALTER MOLDED CASE CIRCUIT BREAKER LEAKAGE TYPE	30-300-500	1	10	1,73	0,0042809
MTL35-3200	3P	35KA 200A TERMİK MANYETİK ŞALTER MOLDED CASE CIRCUIT BREAKER LEAKAGE TYPE	30-300-500	1	10	1,73	0,0042809
MTL35-3250	3P	35KA 250A TERMİK MANYETİK ŞALTER MOLDED CASE CIRCUIT BREAKER LEAKAGE TYPE	30-300-500	1	10	1,73	0,0042809
MTL35-3315	3P	35KA 315A TERMİK MANYETİK ŞALTER MOLDED CASE CIRCUIT BREAKER LEAKAGE TYPE	30-300-500	1	10	1,73	0,0042809
MTL35-3400	3P	35KA 400A TERMİK MANYETİK ŞALTER MOLDED CASE CIRCUIT BREAKER LEAKAGE TYPE	30-300-500	1	10	1,73	0,0042809
MTL35-3630	3P	35KA 630A TERMİK MANYETİK ŞALTER MOLDED CASE CIRCUIT BREAKER LEAKAGE TYPE	30-300-500	1	10	1,73	0,0042809
MTL42-3100	3P	42KA 100A TERMİK MANYETİK ŞALTER MOLDED CASE CIRCUIT BREAKER LEAKAGE TYPE	30-300-500	1	10	1,73	0,0042809
MTL42-3125	3P	42KA 125A TERMİK MANYETİK ŞALTER MOLDED CASE CIRCUIT BREAKER LEAKAGE TYPE	30-300-500	1	10	1,73	0,0042809
MTL42-3160	3P	42KA 160A TERMİK MANYETİK ŞALTER MOLDED CASE CIRCUIT BREAKER LEAKAGE TYPE	30-300-500	1	10	1,73	0,0042809
MTL42-3200	3P	42KA 200A TERMİK MANYETİK ŞALTER MOLDED CASE CIRCUIT BREAKER LEAKAGE TYPE	30-300-500	1	10	1,73	0,0042809
MTL42-3250	3P	42KA 250A TERMİK MANYETİK ŞALTER MOLDED CASE CIRCUIT BREAKER LEAKAGE TYPE	30-300-500	1	10	1,73	0,0042809
MTL50-30315	3P	50KA 315A TERMİK MANYETİK ŞALTER MOLDED CASE CIRCUIT BREAKER LEAKAGE TYPE	100-300-500	1	8	2,213	0,005351125
MTL50-30400	3P	50KA 400A TERMİK MANYETİK ŞALTER MOLDED CASE CIRCUIT BREAKER LEAKAGE TYPE	100-300-500	1	8	2,213	0,005351125
MTL50-30630	3P	50KA 630A TERMİK MANYETİK ŞALTER MOLDED CASE CIRCUIT BREAKER LEAKAGE TYPE	100-300-500	1	8	2,213	0,005351125
MTL50-30800	3P	50KA 800A TERMİK MANYETİK ŞALTER MOLDED CASE CIRCUIT BREAKER LEAKAGE TYPE	100-300-500	1	10	1,73	0,0042809
MTL22-4016	4P	22KA 16A TERMİK MANYETİK ŞALTER MOLDED CASE CIRCUIT BREAKER LEAKAGE TYPE	30-300-500	1	16	1,188	0,0033345
MTL22-4025	4P	22KA 25A TERMİK MANYETİK ŞALTER MOLDED CASE CIRCUIT BREAKER LEAKAGE TYPE	30-300-500	1	16	1,188	0,0033345
MTL22-4040	4P	22KA 40A TERMİK MANYETİK ŞALTER MOLDED CASE CIRCUIT BREAKER LEAKAGE TYPE	30-300-500	1	16	1,1875	0,0033345
MTL22-4063	4P	22KA 63A TERMİK MANYETİK ŞALTER MOLDED CASE CIRCUIT BREAKER LEAKAGE TYPE	30-300-500	1	16	1,3125	0,0033345
MTL22-4100	4P	22KA 100A TERMİK MANYETİK ŞALTER MOLDED CASE CIRCUIT BREAKER LEAKAGE TYPE	30-300-500	1	16	1,313	0,0033345
MTL22-4125	4P	22KA 125A TERMİK MANYETİK ŞALTER MOLDED CASE CIRCUIT BREAKER LEAKAGE TYPE	30-300-500	1	16	1,313	0,0033345
MTL25-4016	4P	25KA 16A TERMİK MANYETİK ŞALTER MOLDED CASE CIRCUIT BREAKER LEAKAGE TYPE	30-300-500	1	16	1,1875	0,0033345
MTL25-4025	4P	25KA 25A TERMİK MANYETİK ŞALTER MOLDED CASE CIRCUIT BREAKER LEAKAGE TYPE	30-300-500	1	16	1,188	0,0033345
MTL25-4032	4P	25KA 32A TERMİK MANYETİK ŞALTER MOLDED CASE CIRCUIT BREAKER LEAKAGE TYPE	30-300-500	1	16	1,188	0,0033345
MTL25-4040	4P	25KA 40A TERMİK MANYETİK ŞALTER MOLDED CASE CIRCUIT BREAKER LEAKAGE TYPE	30-300-500	1	16	1,1875	0,0033345
MTL25-4050	4P	25KA 50A TERMİK MANYETİK ŞALTER MOLDED CASE CIRCUIT BREAKER LEAKAGE TYPE	30-300-500	1	16	1,188	0,0033345
MTL25-4063	4P	25KA 63A TERMİK MANYETİK ŞALTER MOLDED CASE CIRCUIT BREAKER LEAKAGE TYPE	30-300-500	1	16	1,3125	0,0033345
MTL25-4080	4P	25KA 80A TERMİK MANYETİK ŞALTER MOLDED CASE CIRCUIT BREAKER LEAKAGE TYPE	30-300-500	1	16	1,313	0,0033345
MTL25-4100	4P	25KA 100A TERMİK MANYETİK ŞALTER MOLDED CASE CIRCUIT BREAKER LEAKAGE TYPE	30-300-500	1	16	1,3125	0,0033345
MTL25-4125	4P	25KA 125A TERMİK MANYETİK ŞALTER MOLDED CASE CIRCUIT BREAKER LEAKAGE TYPE	30-300-500	1	16	1,3125	0,0033345
MTL35-4100	4P	35KA 100A TERMİK MANYETİK ŞALTER MOLDED CASE CIRCUIT BREAKER LEAKAGE TYPE	30-300-500	1	8	2,2125	0,005351125
MTL35-4125	4P	35KA 125A TERMİK MANYETİK ŞALTER MOLDED CASE CIRCUIT BREAKER LEAKAGE TYPE	30-300-500	1	8	2,2125	0,005351125
MTL35-4160	4P	35KA 160A TERMİK MANYETİK ŞALTER MOLDED CASE CIRCUIT BREAKER LEAKAGE TYPE	30-300-500	1	8	2,2125	0,005351125
MTL35-4200	4P	35KA 200A TERMİK MANYETİK ŞALTER MOLDED CASE CIRCUIT BREAKER LEAKAGE TYPE	30-300-500	1	8	2,2125	0,005351125
MTL35-4250	4P	35KA 250A TERMİK MANYETİK ŞALTER MOLDED CASE CIRCUIT BREAKER LEAKAGE TYPE	30-300-500	1	8	2,2125	0,005351125
MTL42-4100	4P	42KA 100A TERMİK MANYETİK ŞALTER MOLDED CASE CIRCUIT BREAKER LEAKAGE TYPE	30-300-500	1	8	2,2125	0,005351125
MTL42-4125	4P	42KA 125A TERMİK MANYETİK ŞALTER MOLDED CASE CIRCUIT BREAKER LEAKAGE TYPE	30-300-500	1	8	2,2125	0,005351125
MTL42-4160	4P	42KA 160A TERMİK MANYETİK ŞALTER MOLDED CASE CIRCUIT BREAKER LEAKAGE TYPE	30-300-500	1	8	2,2125	0,005351125
MTL42-4200	4P	42KA 200A TERMİK MANYETİK ŞALTER MOLDED CASE CIRCUIT BREAKER LEAKAGE TYPE	30-300-500	1	8	2,2125	0,005351125
MTL42-4250	4P	42KA 250A TERMİK MANYETİK ŞALTER MOLDED CASE CIRCUIT BREAKER LEAKAGE TYPE	30-300-500	1	8	2,2125	0,005351125
MTL50-40315	4P	50KA 315A TERMİK MANYETİK ŞALTER MOLDED CASE CIRCUIT BREAKER LEAKAGE TYPE	100-300-500	1	8	2,213	0,005351125
MTL50-40400	4P	50KA 400A TERMİK MANYETİK ŞALTER MOLDED CASE CIRCUIT BREAKER LEAKAGE TYPE	100-300-500	1	8	2,213	0,005351125
MTL50-40630	4P	50KA 630A TERMİK MANYETİK ŞALTER MOLDED CASE CIRCUIT BREAKER LEAKAGE TYPE	100-300-500	1	8	2,213	0,005351125
MTL50-40800	4P	50KA 800A TERMİK MANYETİK ŞALTER MOLDED CASE CIRCUIT BREAKER LEAKAGE TYPE	100-300-500	1	8	2,213	0,005351125

TERMİK MANYETİK AKSESUARLARI MCCB ACCESSORIES

KOD CODE	AÇIKLAMA DESCRIPTION	KUTU BOX	KOLİ PARCEL	KUTU AĞIRLIK BOX WEIGHT kg	KUTU HACİM BOX VOLUME m3
MTAUX-11250	1NO + 1NC YARDIMCI KONTAK - 160 VE 250A 1NO + 1NC AUXILIARY CONTACT - 160 AND 250A	30	720	0,75	0,001294125
MTAUX-22250	2NO + 2NC YARDIMCI KONTAK - 160 VE 250A 2NO + 2NC AUXILIARY CONTACT - 160 AND 250A	30	540	0,9999	0,00329301
MTALR-00160	ALARM KONTAKT 160A ALARM CONTACT 160A	30	720	0,75	0,001294125
MTALR-00250	ALARM KONTAKT 250A ALARM CONTACT 250A	30	540	0,9999	0,00329301
MTSHT-230160	230V ŞANT TRIP BOBİNİ 160A 230V SHUNT TRIP COIL 160A	30	720	0,75	0,001294125
MTSHT-230250	230V ŞANT TRIP BOBİNİ 250A 230V SHUNT TRIP COIL 250A	30	540	0,9999	0,00329301

AÇIK TİP DEVRE KESİCİLER

AIR CIRCUIT BREAKERS

SABİT TİP
FIXED TYPE

MTACF SERİSİ

TEKNİK BİLGİLER
TECHNICAL INFORMATION



KOD CODE	KUTUP SAYISI POLES	AÇIKLAMA DESCRIPTION	KUTU BOX	KOLİ PARCEL	KUTU AĞIRLIK BOX WEIGHT kg	KUTU HACİM BOX VOLUME m ³
MTACF3-0651000	3P	65KA 1000A AÇIK TİP DEVRE KESİCİ AIR CIRCUIT BREAKERS	1	1	54	0,115197
MTACF3-0651250	3P	65KA 1250A AÇIK TİP DEVRE KESİCİ AIR CIRCUIT BREAKERS	1	1	54	0,115197
MTACF3-0651600	3P	65KA 1600A AÇIK TİP DEVRE KESİCİ AIR CIRCUIT BREAKERS	1	1	56,1	0,115197
MTACF3-0652000	3P	65KA 2000A AÇIK TİP DEVRE KESİCİ AIR CIRCUIT BREAKERS	1	1	56,1	0,115197
MTACF3-0652500	3P	65KA 2500A AÇIK TİP DEVRE KESİCİ AIR CIRCUIT BREAKERS	1	1	66	0,124488
MTACF3-0653200	3P	65KA 3200A AÇIK TİP DEVRE KESİCİ AIR CIRCUIT BREAKERSİ	1	1	66	0,124488
MTACF3-1204000	3P	120KA 4000A AÇIK TİP DEVRE KESİCİ AIR CIRCUIT BREAKERS	1	1	110	0,420608
MTACF3-1205000	3P	120KA 5000A AÇIK TİP DEVRE KESİCİ AIR CIRCUIT BREAKERS	1	1	120	0,420608
MTACF3-1206300	3P	120KA 6300A AÇIK TİP DEVRE KESİCİ AIR CIRCUIT BREAKERS	1	1	130	0,420608
MTACF4-0651000	4P	65KA 1000A AÇIK TİP DEVRE KESİCİ AIR CIRCUIT BREAKERS	1	1	69,3	0,124488
MTACF4-0651250	4P	65KA 1250A AÇIK TİP DEVRE KESİCİ AIR CIRCUIT BREAKERS	1	1	69,3	0,124488
MTACF4-0651600	4P	65KA 1600A AÇIK TİP DEVRE KESİCİ AIR CIRCUIT BREAKERS	1	1	69,3	0,124488
MTACF4-0652000	4P	65KA 2000A AÇIK TİP DEVRE KESİCİ AIR CIRCUIT BREAKERS	1	1	71,3	0,124488
MTACF4-0652500	4P	65KA 2500A AÇIK TİP DEVRE KESİCİ AIR CIRCUIT BREAKERS	1	1	90	0,23316
MTACF4-0653200	4P	65KA 3200A AÇIK TİP DEVRE KESİCİ AIR CIRCUIT BREAKERS	1	1	92,5	0,23316
MTACF4-1204000	4P	120KA 4000A AÇIK TİP DEVRE KESİCİ AIR CIRCUIT BREAKERS	1	1	140,3	0,420608
MTACF4-1205000	4P	120KA 5000A AÇIK TİP DEVRE KESİCİ AIR CIRCUIT BREAKERS	1	1	151,2	0,420608
MTACF4-1206300	4P	120KA 6300A AÇIK TİP DEVRE KESİCİ AIR CIRCUIT BREAKERS	1	1	162,3	0,420608

ÇEKMECELİ TİP
DRAWER TYPE

MTACD SERİSİ

TEKNİK BİLGİLER
TECHNICAL INFORMATION



KOD CODE	KUTUP SAYISI POLES	AÇIKLAMA DESCRIPTION	KUTU BOX	KOLİ PARCEL	KUTU AĞIRLIK BOX WEIGHT kg	KUTU HACİM BOX VOLUME m ³
MTACD3-0651000	3P	65KA 1000A AÇIK TİP DEVRE KESİCİ AIR CIRCUIT BREAKERS	1	1	79,5	0,14664
MTACD3-0651250	3P	65KA 1250A AÇIK TİP DEVRE KESİCİ AIR CIRCUIT BREAKERS	1	1	79,5	0,14664
MTACD3-0651600	3P	65KA 1600A AÇIK TİP DEVRE KESİCİ AIR CIRCUIT BREAKERS	1	1	79,5	0,14664
MTACD3-0652000	3P	65KA 2000A AÇIK TİP DEVRE KESİCİ AIR CIRCUIT BREAKERS	1	1	85,5	0,14664
MTACD3-0652500	3P	65KA 2500A AÇIK TİP DEVRE KESİCİ AIR CIRCUIT BREAKERS	1	1	110	0,20088
MTACD3-0653200	3P	65KA 3200A AÇIK TİP DEVRE KESİCİ AIR CIRCUIT BREAKERS	1	1	110,5	0,20088
MTACD3-1204000	3P	120KA 4000A AÇIK TİP DEVRE KESİCİ AIR CIRCUIT BREAKERS	1	1	175	0,420608
MTACD3-1205000	3P	120KA 5000A AÇIK TİP DEVRE KESİCİ AIR CIRCUIT BREAKERS	1	1	200	0,420608
MTACD3-1206300	3P	120KA 6300A AÇIK TİP DEVRE KESİCİ AIR CIRCUIT BREAKERS	1	1	220	0,420608
MTACD4-0651000	4P	65KA 1000A AÇIK TİP DEVRE KESİCİ AIR CIRCUIT BREAKERS	1	1	98,8	0,20088
MTACD4-0651250	4P	65KA 1250A AÇIK TİP DEVRE KESİCİ AIR CIRCUIT BREAKERS	1	1	98,8	0,20088
MTACD4-0651600	4P	65KA 1600A AÇIK TİP DEVRE KESİCİ AIR CIRCUIT BREAKERS	1	1	98,8	0,20088
MTACD4-0652000	4P	65KA 2000A AÇIK TİP DEVRE KESİCİ AIR CIRCUIT BREAKERS	1	1	105,9	0,20088
MTACD4-0652500	4P	65KA 2500A AÇIK TİP DEVRE KESİCİ AIR CIRCUIT BREAKERS	1	1	123	0,23316
MTACD4-0653200	4P	65KA 3200A AÇIK TİP DEVRE KESİCİ AIR CIRCUIT BREAKERS	1	1	133	0,23316
MTACD4-1204000	4P	120KA 4000A AÇIK TİP DEVRE KESİCİ AIR CIRCUIT BREAKERS	1	1	195	0,420608
MTACD4-1205000	4P	120KA 5000A AÇIK TİP DEVRE KESİCİ AIR CIRCUIT BREAKERS	1	1	215	0,420608
MTACD4-1206300	4P	120KA 6300A AÇIK TİP DEVRE KESİCİ AIR CIRCUIT BREAKERS	1	1	225	0,420608

TOROID TRAFÖ

TOROIDAL TRANSFORMER

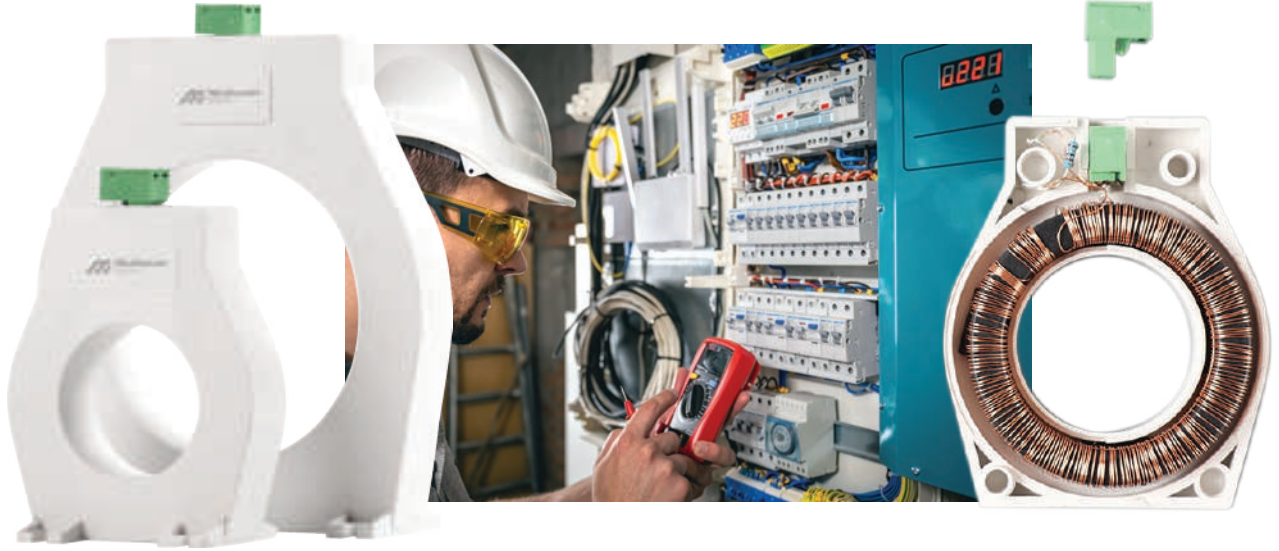

Düşük Elektromanyetik Girişim (EMI): Minimum EMI yayılımı ile hassas elektronik cihazların yanında güvenle kullanım sağlar.

Low Electromagnetic Interference (EMI): Enables safe use next to sensitive electronic devices with minimum EMI emissions.

MTC00 SERİSİ

TEKNİK BİLGİLER
TECHNICAL INFORMATION

KOD CODE	AÇIKLAMA DESCRIPTION	KUTU BOX	KOLİ ADET PARCEL	AĞIRLIK WEIGHT	HACİM VOLUME
MTC00-040	40MM TOROID AKIM TRAFÖSÜ TOROID CURRENT TRANSFORMER	1	100	0,14	0,000418
MTC00-080	80MM TOROID AKIM TRAFÖSÜ TOROID CURRENT TRANSFORMER	1	60	0,265	0,000934999
MTC00-120	120MM TOROID AKIM TRAFÖSÜ TOROID CURRENT TRANSFORMER	1	60	0,34167	0,001528967
MTC00-160	160MM TOROID AKIM TRAFÖSÜ TOROID CURRENT TRANSFORMER	1	30	0,55667	0,002645833
MTC00-210	210MM TOROID AKIM TRAFÖSÜ TOROID CURRENT TRANSFORMER	1	28	0,83929	0,003622929

KAÇAK AKIM ALGILAMA RÖLESİ

EARTH LEAKAGE RELAY



Toroid transformatöründen gelen kaçak akımı ölçerek belirlenen kaçak akım seviyesinin aşılması durumunda devre kesicinin devreyi kesmesini sağlar.

It measures the leakage current coming from the toroid transformer and ensures that the circuit breaker cuts the circuit if the determined leakage current level is exceeded.

MTC00 SERİSİ

TEKNİK BİLGİLER
TECHNICAL INFORMATION

KOD CODE	AÇIKLAMA DESCRIPTION	KUTU BOX	KOLİ ADET PARCEL	AĞIRLIK WEIGHT	HACİM VOLUME
MELR00-01	KAÇAK ALGILAMA RÖLESİ EARTH LEAKAGE RELAY	1	36	0,331	0,000714792

ANALOG ZAMAN SAATİ

ANALOG TIMER

Belirlenen zaman dilimlerine dayalı olarak elektrik devrelerini açıp kapatan bir kontrol cihazıdır. Mekanik veya elektronik bileşenler kullanarak zamanlama işlevlerini gerçekleştirir.

It is a control device that turns electrical circuits on and off based on specified time periods. It performs timing functions using mechanical or electronic components.



ANALOG ZAMAN SAATİ

ANALOG TIMER

Endüstriyel kontrol sistemlerinde, aydınlatma yönetimi, motor kontrolü ve süreç otomasyonunda kullanılır.

It is used in industrial control systems, lighting management, motor control and process automation.



Zaman saatlerinin kullanım yerleri oldukça geniştir. Belirli saatlerde çalışması yine belirlenen süre sonunda devreden çıkması istenen tüm uygulamalarda, örneğin Park sulama sistemleri, yol aydınlatma sistemleri, tarımsal sulama sistemleri, okul-işyeri zili, ısıtma-soğutma sistemlerinde kullanılır. Böylece bu sistemlerin kullanıcı müdahalesi olmadan otomatik olarak ve sadece istenilen süre kadar çalışması sağlanır.

Analog Timer Relay have a wide range of uses. It is used in all applications where it is required to operate at certain hours and be deactivated at the end of the specified period, for example, park irrigation systems, road lighting systems, agricultural irrigation systems, school-office bells, heating-cooling systems. This ensures that these systems operate automatically and only for the desired period of time, without user intervention.

MATRO SERİSİ

TEKNİK BİLGİLER

TECHNICAL INFORMATION

KOD CODE	AÇIKLAMA DESCRIPTION	KUTU BOX	KOLİ PARCEL	KUTU AĞIRLIK BOX WEIGHT kg	KUTU HACİM BOX VOLUME m ³
MATRO-100	100SA ANALOG ZAMAN SAATİ ANALOG TIMER	1	100	0,088	0,0002162

DARBE AKIM RÖLESİ

IMPULSE RELAY

Endüstriyel ve ticari tesislerde, elektrik sistemlerini, kısa devre veya yıldırım darbeleri gibi ani yüksek akım artışlarından korumak için kullanılır.

It is used in industrial and commercial facilities to protect electrical systems from sudden high current increases such as short circuits or lightning strikes.



Gelişmiş sensörler ve hassas algılama teknolojisi ile ani yüksek akım darbelerine karşı hızlı ve etkili koruma sağlar. Yenilikçi tasarımı, enerji verimliliğini ve sistem güvenliğini artırırken, modüler yapı ve düşük güç tüketimi ile maliyet etkinliği sunar.

With advanced sensors and sensitive detection technology, it provides fast and effective protection against sudden high current pulses. Its innovative design increases energy efficiency and system security, while offering cost efficiency with modular structure and low power consumption.

- Elektrik sistemlerini ani akım artışlarından korur.
Protects electrical systems from sudden current increases
- Ekipman ve devrelerin hasardan korunmasını sağlar.
Equipment and circuits provides protection from damage.
- Darbe akımı anlık yüksek akımlara, kaçak akım sürekli kaçaklara karşı korur.
Impulse current to instantaneous high currents, Leakage current constantly protects against leaks.

Anlık yüksek akım darbelerini algılayıp tepki veren bir elektrik koruma cihazıdır. Darbe akım röleleri, algıladıkları anormal akım seviyelerine hızlı bir şekilde tepki vererek, sistemi korumak üzere tasarlanmış devreleri aktif hale getirir veya devreyi keser. Bu sayede, elektrikli ekipmanlar ve devreler aşırı akım hasarından korunmuş olur.

It is an electrical protection device that detects and reacts to instantaneous high current pulses. Impulse current relays react quickly to abnormal current levels they detect, activating or breaking circuits designed to protect the system. In this way, electrical devices and circuits are free from overcurrent damage.

MIR00 SERİSİ

TEKNİK BİLGİLER

TECHNICAL INFORMATION

KOD CODE	AÇIKLAMA DESCRIPTION	KUTU BOX	KOLİ PARCEL	KUTU AĞIRLIK BOX WEIGHT kg	KUTU HACİM BOX VOLUME m3
MIR00-123016	16A 1NO DARBE AKIM ANAHTARI IMPULSE RELAY	1	120	0,122	0,000205833
MIR00-223016	16A 2NO DARBE AKIM ANAHTARI IMPULSE RELAY	1	120	0,122	0,000205833

AC KONTAKTÖR

AC CONTACTOR

Üstün malzeme kalitesi ve ileri mühendislik ile yüksek güvenilirlik ve uzun ömür sunar. Düşük enerji tüketimli bobinleri, enerji verimliliğini artırırken, geniş ürün yelpazesi farklı akım ve voltaj ihtiyaçlarına uygun çözümler sağlar.

It offers high distribution and long life with superior material quality and advanced engineering. While its low energy consumption coils increase the energy range, its wide product range provides solutions suitable for different currents and voltages.

Alternatif akım (AC) sistemlerinde kullanılan bir tür elektrikli anahtarlama cihazıdır. Genellikle, yüksek akım taşıyan elektrik devrelerini uzaktan kontrol etmek, bağlamak ve kesmek için tasarlanmıştır. 9A-95A aralığında 4kW-45kW olmak üzere Aksesuar seçenekleriyle sunulmaktadır.

It is a type of electrical switching device used in alternating current (AC) systems. They are generally designed to remotely control, connect and disconnect electrical circuits carrying high currents. It is offered with accessory options in the range of 9A-95A, 4kW-45kW.



- Kontaktör serisi, 600V AC anma gerilimine, 50Hz veya 60Hz frekansına, 220V'a kadar DC gerilimine, 95A anma akımına kadar açma ve kapama için devrede kullanıma uygundur

- Asansörler, elektrik motorları, aydınlatma sistemleri, ısıtma, havalandırma ve klima (HVAC) sistemleri gibi uygulamalarda yaygın olarak kullanılırlar.

- Contactor series contactor is suitable for using in the circuit up to therated voltage 600V AC 50Hz or 60Hz,DC voltage 220V ratecurrent Suitable for use in circuits for opening and closing up to 95A rated current

- They are widely used in applications such as elevators, electric motors, lighting systems, and heating, ventilation, and air conditioning (HVAC) systems.

AC KONTAKTÖR AC CONTACTOR



MTMA SERİSİ

TEKNİK BİLGİLER
TECHNICAL INFORMATION

KOD CODE	KUTUP SAYISI POLES	AÇIKLAMA DESCRIPTION	KUTU BOX	KOLİ PARCEL	KUTU AĞIRLIK BOX WEIGHT kg	KUTU HACİM BOX VOLUME m ³
MTMA10-3009	3P	9A 4KW/AC-3 KONTAKTÖR CONTACTOR (1NO) 230 V AC	1	60	0,227	0,00429
MTMA01-3009	3P	9A 4KW/AC-3 KONTAKTÖR CONTACTOR (1NC) 230 V AC	1	60	0,227	0,00429
MTMA10-3012	3P	12A 5.5KW/AC-3 KONTAKTÖR CONTACTOR (1NO) 230 V AC	1	60	0,227	0,00429
MTMA01-3012	3P	12A 5.5KW/AC-3 KONTAKTÖR CONTACTOR (1NC) 230 V AC	1	60	0,227	0,00429
MTMA10-3018	3P	18A 7.5KW/AC-3 KONTAKTÖR CONTACTOR (1NO) 230 V AC	1	60	0,227	0,00429
MTMA01-3018	3P	18A 7.5KW/AC-3 KONTAKTÖR CONTACTOR (1NC) 230 V AC	1	60	0,227	0,00429
MTMA10-3025	3P	25A 11KW/AC-3 KONTAKTÖR CONTACTOR (1NO) 230 V AC	1	40	0,227	0,000687
MTMA01-3025	3P	25A 11KW/AC-3 KONTAKTÖR CONTACTOR (1NC) 230 V AC	1	40	0,227	0,000687
MTMA10-3032	3P	32A 15KW/AC-3 KONTAKTÖR CONTACTOR (1NO) 230 V AC	1	40	0,227	0,000687
MTMA01-3032	3P	32A 15KW/AC-3 KONTAKTÖR CONTACTOR (1NC) 230 V AC	1	40	0,227	0,000687
MTMA10-3040	3P	40A 18.5KW/AC-3 KONTAKTÖR CONTACTOR (1NO) 230 V AC	1	40	0,227	0,000687
MTMA01-3040	3P	40A 18.5KW/AC-3 KONTAKTÖR CONTACTOR (1NC) 230 V AC	1	40	0,227	0,000687
MTMA11-3050	3P	50A 22KW/AC-3 KONTAKTÖR CONTACTOR (1NO+1NC) 230 V AC	1	16	1,031	0,001680075
MTMA11-3065	3P	65A 30KW/AC-3 KONTAKTÖR CONTACTOR (1NO+1NC) 230 V AC	1	16	1,031	0,001680075
MTMA11-3080	3P	80A 37KW/AC-3 KONTAKTÖR CONTACTOR (1NO+1NC) 230 V AC	1	12	1,417	0,001989167
MTMA11-3095	3P	95A 45KW/AC-3 KONTAKTÖR CONTACTOR (1NO+1NC) 230 V AC	1	12	1,417	0,001989167

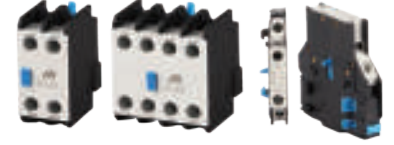

AC KONTAKTÖR YARDIMCI BLOKLAR AC CONTACTOR AUXILIARY BLOCKS

MTMAUX-UPBLOCKA	AC-3 KONTAKTÖR ÜST BLOK A (1NO + 1NC) AC CONTACTOR AUXILIARY BLOCKS	1	1	0,195	0,000343403
MTMAUX-UPBLOCKB	AC-3 KONTAKTÖR ÜST BLOK B (2NO + 2NC) AC CONTACTOR AUXILIARY BLOCKS	1	1	0,195	0,000343403
MTMAUX-SIDEBLOCK	AC-3 KONTAKTÖR YAN BLOK (1NO + 1NC) AC CONTACTOR AUXILIARY BLOCKS	1	1	0,195	0,000343403

MİNİ KONTAKTÖRLER

MINI CONTACTORS

MTMK SERİSİ

TEKNİK BİLGİLER
TECHNICAL INFORMATION



KOD CODE	KUTUP SAYISI POLES	AÇIKLAMA DESCRIPTION	KUTU BOX	KOLİ PARCEL	KUTU AĞIRLIK BOX WEIGHT kg	KUTU HACİM BOX VOLUME m ³
MTMK10-3009	3P	3P 9A 4KW MİNİ KONTAKTÖR MINI CONTACTORS (1NO) 230 V AC	1	100	0,194	0,00023205
MTMK10-3012	3P	3P 12A 5,5KW MİNİ KONTAKTÖR MINI CONTACTORS (1NO) 230 V AC	1	100	0,194	0,00023205
MTMK10-3016	3P	3P 16A 7,5KW MİNİ KONTAKTÖR MINI CONTACTORS (1NO) 230 V AC	1	100	0,194	0,00023205
MTMK01-3009	3P	3P 9A 4KW MİNİ KONTAKTÖR MINI CONTACTORS (1NC) 230C AC	1	100	0,194	0,00023205
MTMK01-3012	3P	3P 12A 5.5KW MİNİ KONTAKTÖR MINI CONTACTORS (1NC) 230C AC	1	100	0,194	0,00023205
MTMK01-3016	3P	3P 16A 7.5KW MİNİ KONTAKTÖR MINI CONTACTORS (1NC) 230C AC	1	100	0,194	0,00023205
MTMK10-3009DC24	3P	3P 9A 4KW MİNİ KONTAKTÖR MINI CONTACTORS (1NO) 24V DC	1	100	0,194	0,00023205
MTMK10-3012DC24	3P	3P 12A 5.5KW MİNİ KONTAKTÖR MINI CONTACTORS (1NO) 24V DC	1	100	0,194	0,00023205
MTMK10-3016DC24	3P	3P 16A 7.5KW MİNİ KONTAKTÖR MINI CONTACTORS (1NO) 24V DC	1	100	0,194	0,00023205
MTMK01-3009DC24	3P	3P 9A 4KW MİNİ KONTAKTÖR MINI CONTACTORS (1NC) 24V DC	1	100	0,194	0,00023205
MTMK01-3012DC24	3P	3P 12A 5.5KW MİNİ KONTAKTÖR MINI CONTACTORS (1NC) 24V DC	1	100	0,194	0,00023205
MTMK01-3016DC24	3P	3P 16A 7.5KW MİNİ KONTAKTÖR MINI CONTACTORS (1NC) 24V DC	1	100	0,194	0,00023205

AC KOMPANZASYON KONTAKTÖRLERİ

AC COMPENSATION CONTACTORS

MTMAC SERİSİ

TEKNİK BİLGİLER
TECHNICAL INFORMATION

KOD CODE	KUTUP SAYISI POLES	AÇIKLAMA DESCRIPTION	KUTU BOX	KOLİ PARCEL	BİRİM AĞIRLIK UNIT WEIGHT kg	BİRİM HACİM UNIT VOLUME m ³
MTMAC1-318	3P	18A 7,5KVAR	1	32	0,594	0,001300777
MTMAC1-325	3P	25A 12KVAR	1	32	0,625	0,001300777
MTMAC1-332	3P	32A 18KVAR	1	32	0,625	0,001300777
MTMAC1-343	3P	43A 20KVAR	1	16	0,625	0,001300777
MTMAC1-350	3P	50A 25KVAR	1	16	1,063	0,00266475
MTMAC1-365	3P	65A 30KVAR	1	16	0,625	0,001300777
MTMAC1-380	3P	80A 40KVAR	1	16	1,063	0,00266475
MTMAC1-395	3P	95A 50KVAR	1	16	1,063	0,00266475



MODÜLER KONTAKTÖRLER

MODULAR CONTACTOR



MTMCO SERİSİ

TEKNİK BİLGİLER TECHNICAL INFORMATION

KOD CODE	KUTUP SAYISI POLES	AÇIKLAMA DESCRIPTION	KUTU BOX	KOLİ PARCEL	KUTU AĞIRLIK BOX WEIGHT kg	KUTU HACİM BOX VOLUME m3
MTMCO-201611	2P	16A 1NO+1NC 18MM MODÜLER KONTAKTÖR MODULAR CONTACTOR	1	140	0,12929	0,000190286
MTMCO-201620	2P	16A 2NO 18MM MODÜLER KONTAKTÖR MODULAR CONTACTOR	1	140	0,12929	0,000190286
MTMCO-201602	2P	16A 2NC 18MM MODÜLER KONTAKTÖR MODULAR CONTACTOR	1	140	0,12929	0,000190286
MTMCO-202511	2P	25A 1NO+1NC 18MM MODÜLER KONTAKTÖR MODULAR CONTACTOR	1	140	0,12929	0,000190286
MTMCO-202520	2P	25A 2NO 18MM MODÜLER KONTAKTÖR MODULAR CONTACTOR	1	140	0,12929	0,000190286
MTMCO-202502	2P	25A 2NC 18MM MODÜLER KONTAKTÖR MODULAR CONTACTOR	1	140	0,12929	0,000190286
MTMCO-203211	2P	32A 1NO+1NC 36MM MODÜLER KONTAKTÖR MODULAR CONTACTOR	1	70	0,25286	0,000380571
MTMCO-203220	2P	32A 2NO 36MM MODÜLER KONTAKTÖR MODULAR CONTACTOR	1	70	0,25286	0,000380571
MTMCO-203202	2P	32A 2NC 36MM MODÜLER KONTAKTÖR MODULAR CONTACTOR	1	70	0,25286	0,000380571
MTMCO-204011	2P	40A 1NO+1NC 36MM MODÜLER KONTAKTÖR MODULAR CONTACTOR	1	70	0,25286	0,000380571
MTMCO-204020	2P	40A 2NO 36MM MODÜLER KONTAKTÖR MODULAR CONTACTOR	1	70	0,25286	0,000380571
MTMCO-204002	2P	40A 2NC 36MM MODÜLER KONTAKTÖR MODULAR CONTACTOR	1	70	0,25286	0,000380571
MTMCO-206311	2P	63A 1NO+1NC 36MM MODÜLER KONTAKTÖR MODULAR CONTACTOR	1	70	0,25286	0,000380571
MTMCO-206320	2P	63A 2NO 36MM MODÜLER KONTAKTÖR MODULAR CONTACTOR	1	70	0,25286	0,000380571
MTMCO-206302	2P	63A 2NC 36MM MODÜLER KONTAKTÖR MODULAR CONTACTOR	1	70	0,25286	0,000380571
MTMCO-208011	2P	80A 1NO+1NC 54MM MODÜLER KONTAKTÖR MODULAR CONTACTOR	1	50	0,404	0,0005328
MTMCO-208020	2P	80A 2NO 54MM MODÜLER KONTAKTÖR MODULAR CONTACTOR	1	50	0,404	0,0005328
MTMCO-208002	2P	80A 2NC 54MM MODÜLER KONTAKTÖR MODULAR CONTACTOR	1	50	0,404	0,0005328
MTMCO-2010011	2P	100A 1NO+1NC 54MM MODÜLER KONTAKTÖR MODULAR CONTACTOR	1	50	0,404	0,0005328
MTMCO-2010020	2P	100A 2NO 54MM MODÜLER KONTAKTÖR MODULAR CONTACTOR	1	50	0,404	0,0005328
MTMCO-2010002	2P	100A 2NC 54MM MODÜLER KONTAKTÖR MODULAR CONTACTOR	1	50	0,404	0,0005328
MTMCO-401622	4P	16A 2NO+2NC 36MM MODÜLER KONTAKTÖR MODULAR CONTACTOR	1	70	0,23286	0,000380571
MTMCO-401631	4P	16A 3NO+1NC 36MM MODÜLER KONTAKTÖR MODULAR CONTACTOR	1	70	0,23286	0,000380571
MTMCO-401613	4P	16A 1NO+3NC 36MM MODÜLER KONTAKTÖR MODULAR CONTACTOR	1	70	0,23286	0,000380571
MTMCO-401640	4P	16A 4NO 36MM MODÜLER KONTAKTÖR MODULAR CONTACTOR	1	70	0,23286	0,000380571
MTMCO-401604	4P	16A 4NC 36MM MODÜLER KONTAKTÖR MODULAR CONTACTOR	1	70	0,23286	0,000380571
MTMCO-402522	4P	25A 2NO+2NC 36MM MODÜLER KONTAKTÖR MODULAR CONTACTOR	1	70	0,23286	0,000380571
MTMCO-402531	4P	25A 3NO+1NC 36MM MODÜLER KONTAKTÖR MODULAR CONTACTOR	1	70	0,23286	0,000380571
MTMCO-402513	4P	25A 1NO+3NC 36MM MODÜLER KONTAKTÖR MODULAR CONTACTOR	1	70	0,23286	0,000380571
MTMCO-402540	4P	25A 4NO 36MM MODÜLER KONTAKTÖR MODULAR CONTACTOR	1	70	0,23286	0,000380571
MTMCO-402504	4P	25A 4NC 36MM MODÜLER KONTAKTÖR MODULAR CONTACTOR	1	70	0,23286	0,000380571
MTMCO-403222	4P	32A 2NO+2NC 54MM MODÜLER KONTAKTÖR MODULAR CONTACTOR	1	50	0,366	0,0005328
MTMCO-403231	4P	32A 3NO+1NC 54MM MODÜLER KONTAKTÖR MODULAR CONTACTOR	1	50	0,366	0,0005328
MTMCO-403213	4P	32A 1NO+3NC 54MM MODÜLER KONTAKTÖR MODULAR CONTACTOR	1	50	0,366	0,0005328
MTMCO-403240	4P	32A 4NO 54MM MODÜLER KONTAKTÖR MODULAR CONTACTOR	1	50	0,366	0,0005328
MTMCO-403204	4P	32A 4NC 54MM MODÜLER KONTAKTÖR MODULAR CONTACTOR	1	50	0,366	0,0005328
MTMCO-404022	4P	40A 2NO+2NC 54MM MODÜLER KONTAKTÖR MODULAR CONTACTOR	1	50	0,366	0,0005328
MTMCO-404031	4P	40A 3NO+1NC 54MM MODÜLER KONTAKTÖR MODULAR CONTACTOR	1	50	0,366	0,0005328
MTMCO-404013	4P	40A 1NO+3NC 54MM MODÜLER KONTAKTÖR MODULAR CONTACTOR	1	50	0,366	0,0005328
MTMCO-404040	4P	40A 4NO 54MM MODÜLER KONTAKTÖR MODULAR CONTACTOR	1	50	0,366	0,0005328
MTMCO-404004	4P	40A 4NC 54MM MODÜLER KONTAKTÖR MODULAR CONTACTOR	1	50	0,366	0,0005328
MTMCO-406322	4P	63A 2NO+2NC 54MM MODÜLER KONTAKTÖR MODULAR CONTACTOR	1	50	0,366	0,0005328
MTMCO-406331	4P	63A 3NO+1NC 54MM MODÜLER KONTAKTÖR MODULAR CONTACTOR	1	50	0,366	0,0005328
MTMCO-406313	4P	63A 1NO+3NC 54MM MODÜLER KONTAKTÖR MODULAR CONTACTOR	1	50	0,366	0,0005328
MTMCO-406340	4P	63A 4NO 54MM MODÜLER KONTAKTÖR MODULAR CONTACTOR	1	50	0,366	0,0005328
MTMCO-406304	4P	63A 4NC 54MM MODÜLER KONTAKTÖR MODULAR CONTACTOR	1	50	0,366	0,0005328
MTMCO-408022	4P	80A 2NO+2NC 108MM MODÜLER KONTAKTÖR MODULAR CONTACTOR	1	30	0,673	0,0008372
MTMCO-408031	4P	80A 3NO+1NC 108MM MODÜLER KONTAKTÖR MODULAR CONTACTOR	1	30	0,673	0,0008372
MTMCO-408013	4P	80A 1NO+3NC 108MM MODÜLER KONTAKTÖR MODULAR CONTACTOR	1	30	0,673	0,0008372
MTMCO-408080	4P	80A 4NO 108MM MODÜLER KONTAKTÖR MODULAR CONTACTOR	1	30	0,673	0,0008372
MTMCO-408004	4P	80A 4NC 108MM MODÜLER KONTAKTÖR MODULAR CONTACTOR	1	30	0,673	0,0008372
MTMCO-410022	4P	100A 2NO+2NC 108MM MODÜLER KONTAKTÖR MODULAR CONTACTOR	1	30	0,673	0,0008372
MTMCO-410031	4P	100A 3NO+1NC 108MM MODÜLER KONTAKTÖR MODULAR CONTACTOR	1	30	0,673	0,0008372
MTMCO-410013	4P	100A 1NO+3NC 108MM MODÜLER KONTAKTÖR MODULAR CONTACTOR	1	30	0,673	0,0008372
MTMCO-410040	4P	100A 4NO 108MM MODÜLER KONTAKTÖR MODULAR CONTACTOR	1	30	0,673	0,0008372
MTMCO-410004	4P	100A 4NC 108MM MODÜLER KONTAKTÖR MODULAR CONTACTOR	1	30	0,673	0,0008372



MTTR SERİSİ

TEKNİK BİLGİLER
TECHNICAL INFORMATION

KOD CODE	KUTUP SAYISI POLES	AÇIKLAMA DESCRIPTION	KUTU BOX	KOLİ PARCEL	KUTU AĞIRLIK BOX WEIGHT kg	KUTU HACİM BOX VOLUME m ³
MTTR1-M1301	3P	0.1-0.16A TERMİK RÖLE THERMAL RELAYS	1	100	0,176	0,000421785
MTTR1-M1302	3P	0.16-0.25A TERMİK RÖLE THERMAL RELAYS	1	100	0,176	0,000421785
MTTR1-M1303	3P	0.25-0.4A TERMİK RÖLE THERMAL RELAYS	1	100	0,176	0,000421785
MTTR1-M1304	3P	0.4-0.63A TERMİK RÖLE THERMAL RELAYS	1	100	0,176	0,000421785
MTTR1-M1305	3P	0.63-1A TERMİK RÖLE THERMAL RELAYS	1	100	0,176	0,000421785
MTTR1-M1306	3P	1-1.6A TERMİK RÖLE THERMAL RELAYS	1	100	0,176	0,000421785
MTTR1-M1307	3P	1.6-2.5A TERMİK RÖLE THERMAL RELAYS	1	100	0,176	0,000421785
MTTR1-M1308	3P	2.5-4A TERMİK RÖLE THERMAL RELAYS	1	100	0,176	0,000421785
MTTR1-M1310	3P	4-6A TERMİK RÖLE THERMAL RELAYS	1	100	0,176	0,000421785
MTTR1-M1312	3P	5.5-8A TERMİK RÖLE THERMAL RELAYS	1	100	0,176	0,000421785
MTTR1-M1314	3P	7-10A TERMİK RÖLE THERMAL RELAYS	1	100	0,176	0,000421785
MTTR1-M1316	3P	9-13A TERMİK RÖLE THERMAL RELAYS	1	100	0,176	0,000421785
MTTR1-M1321	3P	12-18A TERMİK RÖLE THERMAL RELAYS	1	100	0,176	0,000421785
MTTR1-M1322	3P	17-25A TERMİK RÖLE THERMAL RELAYS	1	100	0,176	0,000421785
MTTR2-M2353	3P	23-32A TERMİK RÖLE THERMAL RELAYS	1	75	0,267	0,000565963
MTTR2-M2355	3P	30-40A TERMİK RÖLE THERMAL RELAYS	1	75	0,267	0,000565963
MTTR3-M3322	3P	17-25A TERMİK RÖLE (BÜYÜK) THERMAL RELAYS (BIG)	1	50	0,46	0,000848945
MTTR3-M3353	3P	23-32A TERMİK RÖLE (BÜYÜK) THERMAL RELAYS (BIG)	1	50	0,46	0,000848945
MTTR3-M3355	3P	30-40A TERMİK RÖLE (BÜYÜK) THERMAL RELAYS (BIG)	1	50	0,46	0,000848945
MTTR3-M3357	3P	37-50A TERMİK RÖLE THERMAL RELAYS	1	50	0,46	0,000848945
MTTR3-M3359	3P	48-65A TERMİK RÖLE THERMAL RELAYS	1	50	0,46	0,000848945
MTTR3-M3361	3P	55-70A TERMİK RÖLE THERMAL RELAYS	1	50	0,46	0,000848945
MTTR3-M3363	3P	63-80A TERMİK RÖLE THERMAL RELAYS	1	50	0,46	0,000848945
MTTR3-M3365	3P	80-93A TERMİK RÖLE THERMAL RELAYS	1	50	0,46	0,000848945

MOTOR KORUMA ŞALTERLERİ

MOTOR PROTECTION SWITCHES

MTPSO SERİSİ

TEKNİK BİLGİLER
TECHNICAL INFORMATION



KOD CODE	KUTUP SAYISI POLES	AÇIKLAMA DESCRIPTION	KUTU BOX	KOLİ PARCEL	KUTU AĞIRLIK BOX WEIGHT kg	KUTU HACİM BOX VOLUME m ³
MTPSO-250016	3P	0,1-0,16A MOTOR KORUMA ŞALTERİ MOTOR PROTECTION SWITCHES	1	50	0,304	0,0004884
MTPSO-250025	3P	0,16-0,25A MOTOR KORUMA ŞALTERİ MOTOR PROTECTION SWITCHES	1	50	0,304	0,0004884
MTPSO-250040	3P	0,25-0,4A MOTOR KORUMA ŞALTERİ MOTOR PROTECTION SWITCHES	1	50	0,304	0,0004884
MTPSO-250063	3P	0,40-0,63A MOTOR KORUMA ŞALTERİ MOTOR PROTECTION SWITCHES	1	50	0,304	0,0004884
MTPSO-250100	3P	0,63-1A MOTOR KORUMA ŞALTERİ MOTOR PROTECTION SWITCHES	1	50	0,304	0,0004884
MTPSO-250160	3P	1-1,6A MOTOR KORUMA ŞALTERİ MOTOR PROTECTION SWITCHES	1	50	0,304	0,0004884
MTPSO-250250	3P	1,6-2,5A MOTOR KORUMA ŞALTERİ MOTOR PROTECTION SWITCHES	1	50	0,304	0,0004884
MTPSO-250400	3P	2,5-4A MOTOR KORUMA ŞALTERİ MOTOR PROTECTION SWITCHES	1	50	0,304	0,0004884
MTPSO-250630	3P	4-6,3A MOTOR KORUMA ŞALTERİ MOTOR PROTECTION SWITCHES	1	50	0,304	0,0004884
MTPSO-251000	3P	6-10A MOTOR KORUMA ŞALTERİ MOTOR PROTECTION SWITCHES	1	50	0,304	0,0004884
MTPSO-251400	3P	9-14A MOTOR KORUMA ŞALTERİ MOTOR PROTECTION SWITCHES	1	50	0,304	0,0004884
MTPSO-251800	3P	13-18A MOTOR KORUMA ŞALTERİ MOTOR PROTECTION SWITCHES	1	50	0,304	0,0004884
MTPSO-252300	3P	17-23A MOTOR KORUMA ŞALTERİ MOTOR PROTECTION SWITCHES	1	50	0,304	0,0004884
MTPSO-252500	3P	20-25A MOTOR KORUMA ŞALTERİ MOTOR PROTECTION SWITCHES	1	50	0,304	0,0004884
MTPSO-253200	3P	24-32A MOTOR KORUMA ŞALTERİ MOTOR PROTECTION SWITCHES	1	50	0,304	0,0004884
MTPS1-804000	3P	25-40A MOTOR KORUMA ŞALTERİ MOTOR PROTECTION SWITCHES	1	25	0,92	0,874
MTPS1-805000	3P	36-50A MOTOR KORUMA ŞALTERİ MOTOR PROTECTION SWITCHES	1	25	0,92	0,874
MTPS1-806300	3P	40-63A MOTOR KORUMA ŞALTERİ MOTOR PROTECTION SWITCHES	1	25	0,92	0,874
MTPS1-808000	3P	56-80A MOTOR KORUMA ŞALTERİ MOTOR PROTECTION SWITCHES	1	25	0,92	0,874

MOTOR KORUMA AKSESUARLARI

MOTOR PROTECTION ACCESSORIES



MTPSO-F11	1NO + 1NC YARDIMCI KONTAK - ÖNDEN MONTELİ AUXILIARY CONTACT - FRONT MOUNTED	10	500	0,204	0,00062985
MTPSO-F20	2NO YARDIMCI KONTAK - ÖNDEN MONTELİ AUXILIARY CONTACT - FRONT MOUNTED	10	500	0,204	0,00062985
MTPSO-L11	MTMP-25 1NO + 1NC YARDIMCI KONTAK - YANDAN MONTELİ AUXILIARY CONTACT - SIDE MOUNTED	10	500	0,412	0,0152775
MTPSO-L20	MTMP-25 2NO YARDIMCI KONTAK - YANDAN MONTELİ AUXILIARY CONTACT - SIDE MOUNTED	10	500	0,412	0,0152775
MTPS1-L11	MTMP-80 1NO + 1NC YARDIMCI KONTAK - YANDAN MONTELİ AUXILIARY CONTACT - SIDE MOUNTED	10	500	0,42	0,01648
MTPS1-L20	MTMP-80 2NO YARDIMCI KONTAK - YANDAN MONTELİ AUXILIARY CONTACT - SIDE MOUNTED	10	500	0,42	0,01648
MTPSO-AB	230V ŞANT AÇTIRMA BOBİNİ	1	100	0,11	0,00031635
MTPSO-DG	400V DÜŞÜK GERİLİM AÇTIRMA BOBİNİ	1	100	0,11	0,00031635
MTPSO-IP55K	IP 55 KUTU - MOTOR KORUMA ŞALTERİ	1	50	0,364	0,0152775

 **Mutlusan®**
CHARGEBOX

Sürdürülebilir Güç
"Sustainable Power"

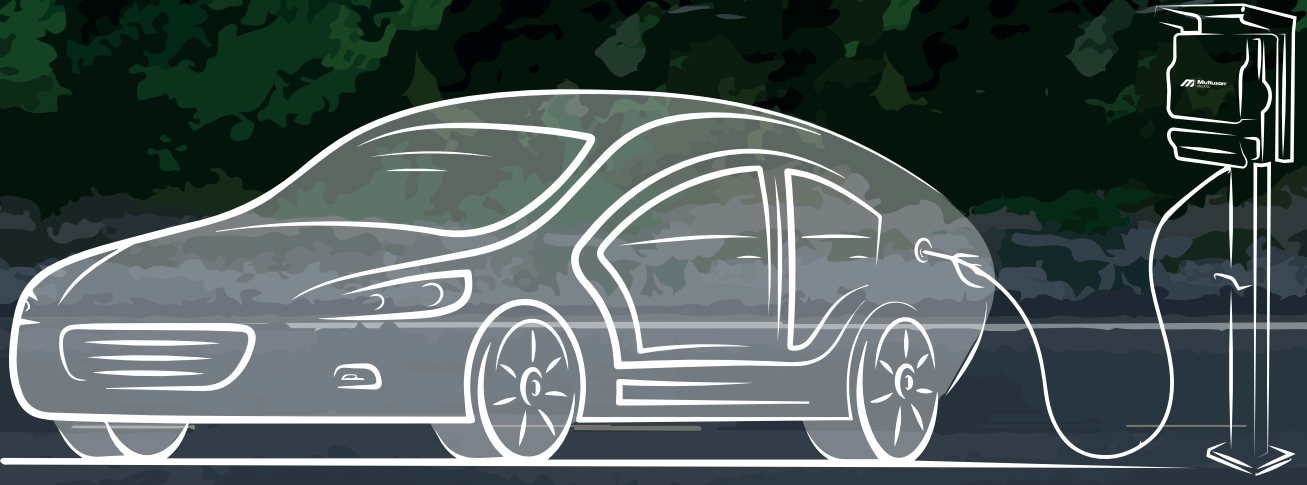

 **Mutlusan®**
electric

**Senin Enerjin,
Senin Mutluluğun!**

YENİ
NEW



**Your Energy,
Your Happiness!**

CE



Kalite Sertifikaları Quality Certificates

- CE Sertifikası ile Avrupa Birliği standartlarına tam uyum
- RoHS Uyumluluğu ile çevre dostu üretim
- Full compliance with European Union standards with CE Certificate
- Environmentally friendly production with RoHS Compliance

Özellikler Features

Tak Çalıştır (Plug&Play)

Kurulumu kolay ve hızlı, hemen şarj etmeye başlayın.

RFID Kimlik Doğrulaması

Kişiselleştirilmiş güvenlik ve kullanım kolaylığı için akıllı doğrulama sistemi.

Modüler elektronik Donanım Rasarımı

Gelecekteki bakım ihtiyacınıza uyum sağlamak için esnek ve yükseltilebilir yapı.

Mutlusan Chargebox ile elektrikli aracınız için güvenli, hızlı ve kolay bir şarj deneyimi yaşayın

Plug & Play: Easy and fast setup, start charging instantly.





RFID Identity Verification: Personalized security and ease of use with smart authentication system.

Modular Electronic Hardware Design: Flexible and upgradeable structure to adapt to your future maintenance needs.

Güvenli, hızlı ve kolay bir şarj deneyiminin tadını çıkarın.
Enjoy a safe, fast and easy charging experience.



Ürün Özellikleri Çizelge Product Features Chart

	 Cablo+Plug 7kW	 Cablo+Plug 22kW	 Socketed 7kW	 Socketed 22kW
AC Power	1P+N+PE	3P+N+PE	1P+N+PE	3P+N+PE
Kimlik Doğrulama Seçeneği Authenticate Option	RFID			
Güç Voltajı Power Voltage	AC230V~±10%	AC400V~±10%	AC230V~±10%	AC400V~±10%
Anma Akımı Rated Current	10-32A			
Sıklık Frequency	50-60Hz			
Kablo Uzunluğu Cable Length	5m			
Bağlantı Seçeneği Connection Option	Tip 2 Kablolu Fiş Type 2 Plug with Cable	Tip 2 Kablolu Fiş Type 2 Plug with Cable	Tip 2 Soket Type 2 Socket	Tip 2 Soket Type 2 Socket
Ağırlık Weight	5.6 KG	6.8 KG	3.45 KG	3.7 KG
IP Sınıfı IP Grade	IP 55			
Çalışma Sıcaklığı Working Temperature	-40°C ~70°C			
Renk Color	Beyaz - White			
Montaj Seçeneği Mounting Option	Duvara Montaj / Kaide Montajı Wall Mount / Pedestal Mounting			

Charge box



Mutlusan Chargebox, elektrikli araçların tek fazlı veya üç fazlı yapılarında alternatif akım ile şarj edilmesi için özel olarak geliştirilmiş bir Elektrikli Araç şarj kutusudur.

-IP55 koruma seviyesiyle ChargeBox, toz ve suya karşı üstün koruma sağlayarak, her türlü dış mekan koşulunda güvenli ve etkili kullanım sunar.

-Kablo versiyonu ve soketli versiyonu olmak üzere iki farklı versiyon ile ihtiyaçlarınıza en uygun çözümü sağlar.

Mutlusan Chargebox is an Electric Vehicle charging box specially developed for charging electric vehicles with alternating current in single-phase or three-phase structures.

-With its IP55 protection level, ChargeBox provides superior protection against dust and water, ensuring safe and effective use in all outdoor conditions.

-Provides the most suitable solution for your needs with two versions: Cable version and socket version.

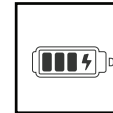

Charge box

ARAÇ ŞARJ CİHAZLARI CAR CHARGERS



MUTLUSAN CHARGEBOX 22 KW EV CHARGER MUTLUSAN CHARGEBOX 22 KW EV CHARGER

KOD CODE	AÇIKLAMA DESCRIPTION	ADET QUANTITY	BİRİM AĞIRLIK UNIT WEIGHT kg	BİRİM HACİM UNIT VOLUME m3
001 191 022001 00 00	MUTLUSAN CHARGEBOX 22 KW EV CHARGER (SOKETLİ) MUTLUSAN CHARGEBOX 22 KW EV CHARGER (SOCKETED)	1	3,7	0,0356928
001 191 022002 00 00	MUTLUSAN CHARGEBOX 22 KW EV CHARGER (KABLOLU) MUTLUSAN CHARGEBOX 22 KW EV CHARGER (WIRED)	1	6,8	0,0356928
001 191 022011 00 00	MUTLUSAN CHARGEBOX 22 KW RFID EKLENTİLİ EV CHARGER (SOKETLİ) MUTLUSAN CHARGEBOX 22 KW RFID ADDED HOME CHARGER (SOCKETED)	1	3,7	0,0356928
001 191 022012 00 00	MUTLUSAN CHARGEBOX 22 KW RFID EKLENTİLİ EV CHARGE (KABLOLU) MUTLUSAN CHARGEBOX 22 KW RFID ADDED HOME CHARGE (WIRED)	1	6,8	0,0356928

MUTLUSAN CHARGEBOX 7 KW EV CHARGER MUTLUSAN CHARGEBOX 7 KW EV CHARGER

KOD CODE	AÇIKLAMA DESCRIPTION	ADET QUANTITY	ADET QUANTITY	BİRİM HACİM UNIT VOLUME m3
001 191 070001 00 00	MUTLUSAN CHARGEBOX 7 KW EV CHARGER (SOKETLİ) MUTLUSAN CHARGEBOX 7 KW EV CHARGER (SOCKETED)	1	3,45	0,0356928
001 191 070002 00 00	MUTLUSAN CHARGEBOX 7 KW EV CHARGER (KABLOLU) MUTLUSAN CHARGEBOX 7 KW EV CHARGER (WIRED)	1	5,6	0,0356928
001 191 070011 00 00	MUTLUSAN CHARGEBOX 7 KW RFID EKLENTİLİ EV CHARGER (SOKETLİ) MUTLUSAN CHARGEBOX 7 KW RFID ADD-ON HOME CHARGER (SOCKETED)	1	3,45	0,0356928
001 191 070012 00 00	MUTLUSAN CHARGEBOX 7 KW RFID EKLENTİLİ EV CHARGER (KABLOLU) MUTLUSAN CHARGEBOX 7 KW RFID ADD-ON HOME CHARGER (WIRED)	1	5,6	0,0356928

AKSESUAR ACCESSORY

KOD CODE	AÇIKLAMA DESCRIPTION	ADET QUANTITY	ADET QUANTITY	BİRİM HACİM UNIT VOLUME m3
001 191 000054 00 00	M-CHARGEBOX STAND	1	-	-

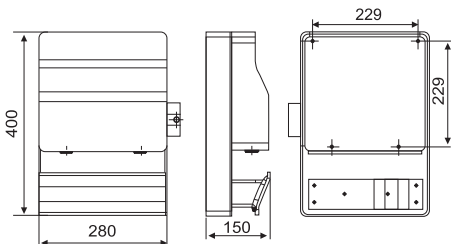

Senin Enerjin,
Senin Mutluluğun!
Your Energy,
Your Happiness!

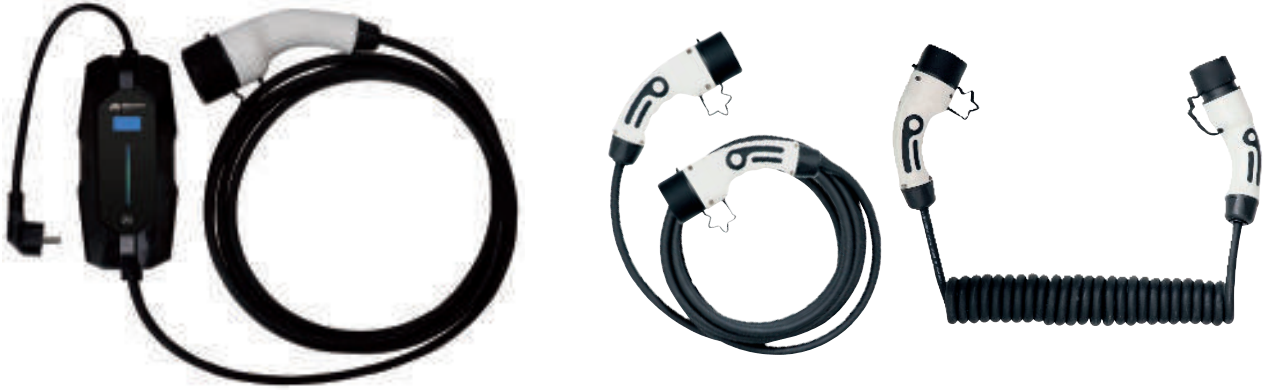

MUTLUSAN CHARGEBOX 3.5 KW TAŞINABİLİR
MUTLUSAN CHARGEBOX 3.5 KW PORTABLE

KOD CODE	AÇIKLAMA DESCRIPTION	ADET QUANTITY	BİRİM AĞIRLIK UNIT WEIGHT kg	BİRİM HACİM UNIT VOLUME m3
001 191 030000 00 00	MUTLUSAN CHARGEBOX 3.5 KW TAŞINABİLİR - MUTLUSAN CHARGEBOX 3.5 KW PORTABLE -	1	2,85	0,0225885

M-CHARGEBOX ÇİFT TARAFILI KABLOLU FİŞ
M-CHARGEBOX DOUBLE SIDED WIRED PLUG

KOD CODE	AÇIKLAMA DESCRIPTION	ADET QUANTITY	BİRİM AĞIRLIK UNIT WEIGHT kg	BİRİM HACİM UNIT VOLUME m3
999 983 000010	MUTLUSAN CHARGEBOX 7 KW ÇİFT TARAFILI KABLOLU FİŞ MUTLUSAN CHARGEBOX 7 KW DOUBLE SIDED CABLE PLUG	1	2,75	0,0225885
999 983 000012	MUTLUSAN CHARGEBOX 22 KW ÇİFT TARAFILI KABLOLU FİŞ MUTLUSAN CHARGEBOX 22 KW DOUBLE SIDED CABLE PLUG	1	4	0,0225885
999 983 000064	MUTLUSAN CHARGEBOX 7 KW ÇİFT TARAFILI KABLOLU FİŞ - SİRALLI MUTLUSAN CHARGEBOX 7 KW DOUBLE SIDED CABLE PLUG - SPIRAL	1	2,75	0,0225885
999 983 000066	MUTLUSAN CHARGEBOX 22 KW ÇİFT TARAFILI KABLOLU FİŞ - SİRALLI MUTLUSAN CHARGEBOX 22 KW DOUBLE SIDED CABLE PLUG - SPIRAL	1	4	0,0225885

RFID KART
RFID CARD

KOD CODE	AÇIKLAMA DESCRIPTION	ADET QUANTITY	BİRİM AĞIRLIK UNIT WEIGHT kg	BİRİM HACİM UNIT VOLUME m3
999 983 000050	MUTLUSAN CHARGEBOX RFID KART MUTLUSAN CHARGEBOX RFID CARD	1	0,075	0,00000005

ÇOK YAKINDA
Very Soon

ChargeBox V EV CHARGE



ChargeBox Smart
With OCPP and multiple options
22kW.



ANAHTAR PRİZ GRUBU

SWITCHES & SOCKETS GROUP



 @mutlusanelectric  @mutlusanelk  @mutlusanelektrik  @mutlusanplastikelektrik

www.mutlusan.com.tr



Modüler

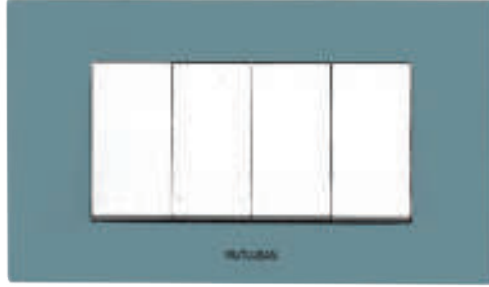

Liva



Ritã

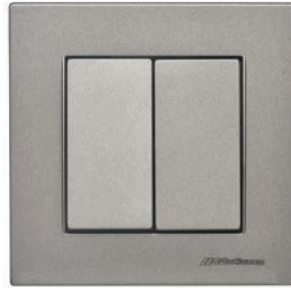

Elitra



Candelã



**PROJENE
DEĞER
KAT
ADD
VALUE
TO YOUR
PROJECT**

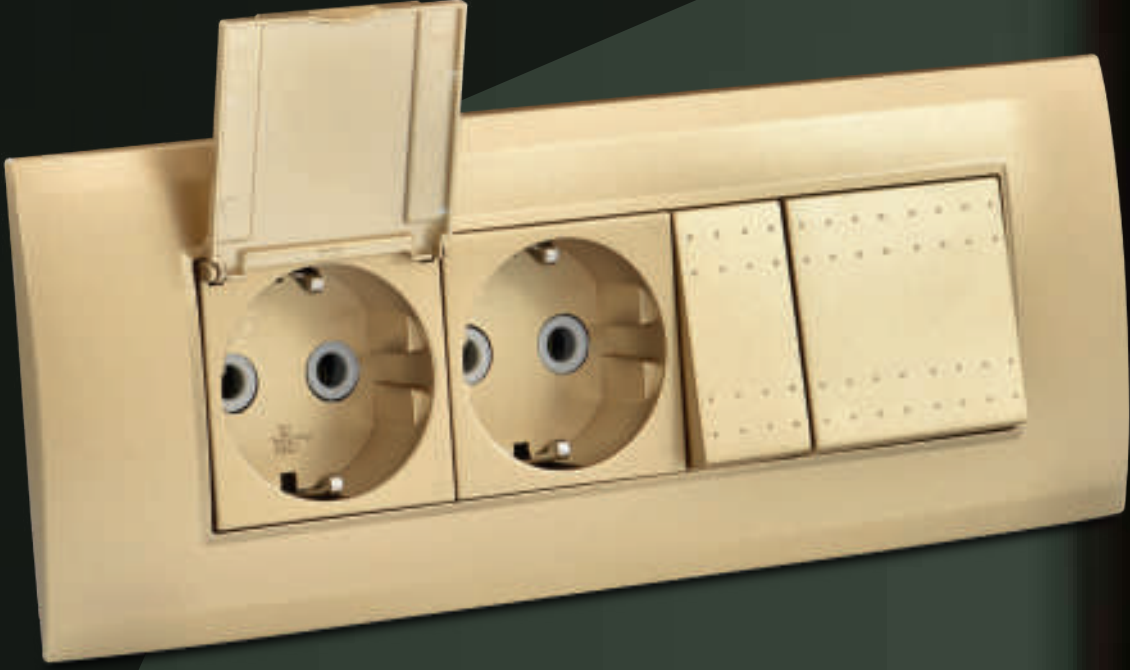

MODÜLER

SİSTEM

Modular System

Yenilikçi Tasarım
Kullanıcı dostu, yenilikçi tasarım mutlusan kalitesi ile buluştu.
Yeni Modüler Seri geleceğin evleri için tasarlandı.

Innovative Design
User-friendly, innovative design meets Mutlusan quality.
The new Modular Series is designed for the homes of the future.

YENİ
NEW



MODÜLER SİSTEM

Modular System

- Avrupa standartlarına uygun üretim
- Yüksek kaliteli hammadde kullanımı
- Koruma seviyesi: IP 20
- Kolay montaj
- Kişileştirilebilir modül ve çerçeveler
- Geniş dekoratif çerçeve yelpazesi
- Yeni ürünlerle sürekli gelişen ürün yelpazesi

- *Production in line with European standards*
- *High quality materials for production*
- *Protection level: IP 20*
- *Simple assembly*
- *User selects modules and frames in accordance with his*
- *Wide range of decorative frames*
- *Constantly expanding of range with new*

Evleri Kişiselleştirmenin Kolay Yolu
The easy way to personalize homes

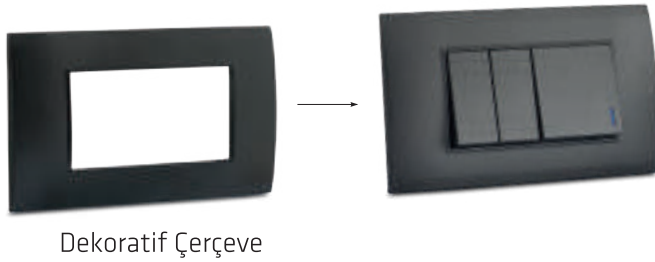
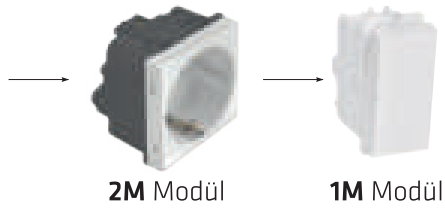
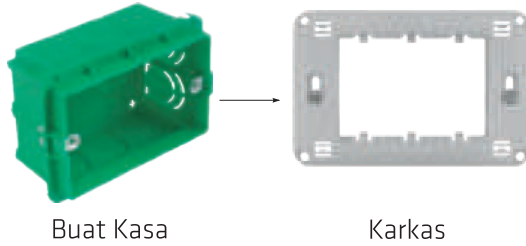



"Tek çerçeve altında birleştirilen Modüler Seri, 2'den 7'ye kadar modül seçenekleri ve 10 farklı renk alternatifi ile hayalinizdeki mekanın çok yönlü işlevselliğini yaratın. Şıklığı ve işlevselliği bir araya getiren bu seri ile kişisel tarzınızı yansıtın."

"Modular Series, combined under a single frame, module options from 2 to 7 and create the versatile functionality of your dream space with 10 different color alternatives. Reflect your personal style with this series that combines elegance and functionality."



MODULAR

Stella

"Kendin Dizayn Et, Şıklığı Yansıt"

"Design Yourself, Reflect Elegance"

RENK SEÇENEKLERİ COLOR OPTIONS



XX:01 Beyaz White



XX:02 Krem Cream



XX:62 Metalik Siyah
Metallic Black



XX:80 Antik Altın
Antik Altın



XX:84 Siyah Black



XX:86 Antrasit Anthracite



XX:88 Su Yeşili
Aqua Green



XX:92 Gümüş Silver



XX:95 Füme Smoked



XX:97 Saten Bej
Satin Beige

ÇERÇEVELER FRAMES

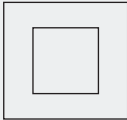

2440 800 12XX
2M 1'li Çerçeve 2M 1 Gang frame

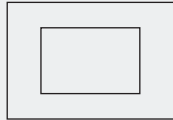

2440 800 13XX
3M 1'li Çerçeve 3M 1 Gang frame

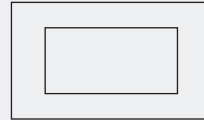

2440 800 14XX
4M 1'li Çerçeve 4M 1 Gang frame



2440 800 17XX
7M 1'li Çerçeve 7M 1 Gang frame

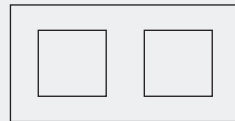

2430 800 12XX
2X2M 1'li Çerçeve 2X2M 1 Gang frame

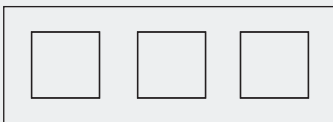

2440 800 12XX
3X2M 1'li Çerçeve 3X2M 1 Gang frame

Bu ürün kodlarında **XX** çerçeve rengini belirtmektedir.
XX specify frame color for these products.

**"Daha ince ve şık tasarımı ile Modüler Seri, her ortama mükemmel uyum sağlar.
Zarif ve modern görünümüyle mekanlarınıza estetik katar."**

With its slimmer and more stylish design, the Modular Series fits perfectly into any environment.
It adds aesthetics to your spaces with its elegant and modern appearance."



MODULAR

Alessa

"Şıklığın ve İşlevselliğin Yeni Adı"

"The New Name of Elegance and Functionality"

TUŞ GRUBU • BUTTON GROUP

1M TUŞLAR 1M BUTTONS



2410 701 01XX
Anahtar Tuş
Switch Button



2410 703 01XX
Vavien Tuş
Multi-way Button



2410 707 01XX
Çağırma Light Tuş
Light Button



2410 707 01XXZ
Zil Anahtarı Tuşu
Bell Button



2410 707 01XXK
Kapı Anahtarı Tuşu
Door Button



2410 706 01XX
Jalu Tuşu
Illu. Switch Button



2410 715 01XX
Işıklı Anahtar Tuş
Illu. Switch Button



2410 716 01XX
Işıklı Vavien Tuş
Illu. Two-way Button



2410 717 01XX
Işıklı Çağırma Light Tuş
Illu. Light Button



2410 717 01XXZ
Işıklı Zil Anahtarı Tuşu
Illu. Bell Button



2410 717 01XXK
Işıklı Kapı Anahtarı Tuşu
Illu. Door Button

2M TUŞLAR 2M BUTTONS



2410 701 02XX
Anahtar Tuş
Switch Button



2410 703 02XX
Vavien Tuş
Multi-way Button



2410 707 02XX
Çağırma Light Tuş
Light Button



2410 707 02XXZ
Zil Anahtarı Tuşu
Bell Button



2410 707 02XXK
Kapı Anahtarı Tuşu
Door Button



2410 706 02XX
Jalu Tuşu
Illu. Switch Button



2410 701 02XX
Anahtar Tuş
Button



2410 703 02XX
Vavien Tuş
Multi-way Button



2410 707 02XX
Çağırma Light Tuş
Light Button



2410 707 02XXZ
Zil Anahtarı Tuşu
Bell Button



2410 707 02XXK
Kapı Anahtarı Tuşu
Door Button

- | | | |
|--|---------------------------------|---------------------------------|
| Beyaz/White 01 | Siyah/Black 84 | Gümüş/ Silver 92 |
| Krem/Cream 02 | Antrasit/Anthracite 86 | Füme/Smoked 95 |
| Metalik Siyah/Metallic Black 62 | Su Yeşili/ Aqua Green 88 | Saten Bej/Satin Beige 97 |
| Antik Altın/Antique Gold 80 | | |

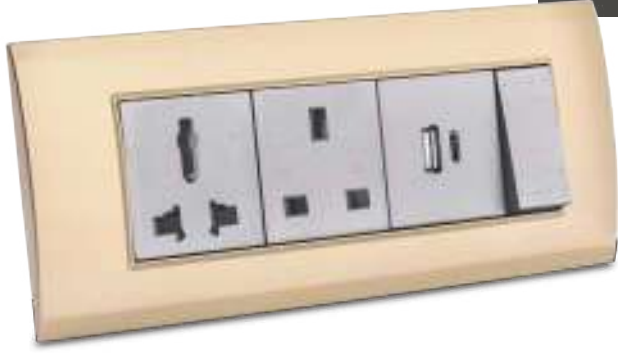

KENDİN DİZAYN ET DESIGN IT YOURSELF

MEKANİZMA + TUŞ ÜRÜN LİSTESİ • MECHANISM + SWITCH PRODUCT LIST

ANAHTAR PRİZ GRUBU

SWITCH SOCKET GROUP

2400 701 0200	ANAHTAR (1M)	1M SWITCH
2400 703 0200	VAVIEN (1M)	1M TWO WAY SWITCH
2400 705 0200	ÇİFT KUTUPLU ANAHTAR (1M)	1M DOUBLE POLE SWITCH
2400 706 0200	STOR/PANJUR (JAKUZİ) (1M)	1M BLIND CONTROL BUTTON
2400 707 0200	LIGHT BUTONU (1M)	1M SINGLE POLE PUSH BUTTON
2400 707 0200Z	ZİL BUTONU (1M)	1M BELL PUSH BUTTON
2400 707 0200K	KAPI BUTONU (1M)	1M KEY PUSH BUTTON
2400 708 0200	ARA VAVIEN (1M)	1M INTERMEDIATE SWITCH

2400 706 02XX	TOPRAKLI PRİZ (2M)	2M 2P+E EARTHED SOCKET
2400 905 02XX	ÇOCUK KORUMALI TOPRAKLI PRİZ (2M)	2M 2P+E EARTHED SOCKET SHUTTERED

2400 910 02XX	KAPAKLI TOP. PRİZ (2M)	2M 2P-E EARTHED SOCKET WITH COVER
2270 911 02XX	KAPAKLI TOP. ÇOCUK KORUMALI PRİZ (2M)	2M 2P+E EARTHED SOCKET SHUTTERED WITH COVER
2400 917 02XX	UPS KAPAKLI FRANSIZ PRİZ (2M)	2M UPS SOCKET WITH COVER



2400 916 02XX

UPS (FRANSIZ) PRİZİ (ÇOCUK KORUMALI) (2M)
2M UPS SOCKET SHUTTERED



2400 920 02XX

ITALYAN PRİZ (1M)
1M ITALIAN SOCKET



2400 925 02XX

UNIVERSAL PRİZ (1M)
1M UNIVERSAL SOCKET



2400 550 02XX

İNGİLİZ PRİZ
2M BRITISH SOCKET



2400 560 02XX

UNIVERSAL PRİZ (2M)
2M UNIVERSAL SOCKET



2400 469 02XX

USB+TYPE-C ŞARJ PRİZİ (2M)
2M USB+TYPE-C SOCKET

TV DATA DIMMER GRUBU

TV DATA DIMMER GROUP

2400 441 02XX	DİMMER 100-500W RC (1M)	1M DIMMER 100-500W RC
2400 541 02XX	DİMMER 100-500W RL CE (1M)	1M DIMMER 100-500 RL CE
2400 442 02XX	DİMMER 100-500W RC (2M)	2M DIMMER 100-500W RC
2400 542 02XX	DİMMER 100-500W RL CE (2M)	2M DIMMER 100-500 RL CE
2400 171 02XX	TV PRİZİ (SONLU) (1M)	1M TV SOCKET END-LINE
2400 170 02XX	TV PRİZİ (GEÇİŞLİ) (1M)	1M TV SOCKET FEED-TROUGH
2400 125 02XX	TELEFON PRİZİ 1XRJ12 (CAT3) (1M)	1M COMMUNICATION SOCKET 1XRJ12 (CAT3)
2400 140 02XX	DATA PRİZİ 1XRJ45 (CAT6) (1M)	1M DATA SOCKET 1XRJ45 (CAT6)

2400 450 02XX	STELLA ENERGY SAVER GEÇİKMESİZ (220V)	STELLA ENERGY SAVER WITHOUT DELAY (220V)
2400 452 02XX	STELLA ENERGY SAVER GEÇİKMELİ (220V)	STELLA ENERGY SAVER WITH DELAY (220V)
2400 462 02XX	STELLA ENERGY SAVER GEÇİKMESİZ (12V)	STELLA ENERGY SAVER WITHOUT DELAY (12V)
2400 464 02XX	STELLA ENERGY SAVER GEÇİKMELİ (12V)	STELLA ENERGY SAVER WITH DELAY (12V)
2400 466 02XX	STELLA ENERGY SAVER GEÇİKMESİZ 12V 13,56RF	STELLA ENERGY SAVER WITHOUT DELAY (12V 13,56RF)
2400 468 02XX	STELLA ENERGY SAVER GEÇİKMELİ 12V 13,56RF	STELLA ENERGY SAVER WITH DELAY (12V 13,56RF)



2400 172 02XX
TV PRİZİ (F DİŞİ) (1M)
1M TV SOCKET END-LINE F/F



2400 482 02XX
RCA PRİZ (1M)
2M 2P+E RCA



2400 916 02XX
BOŞ KAPAK (1M)
1M BLANK COVER



2400 916 02XX
MAVİ LAMBA
BLUE LAMP

TAŞIYICI KAİDE • MOUNTING FRAME

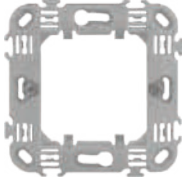

2400 500 1217
Sıva Altı Kasa (2M)
Mounting Casing (2M)



2400 500 1317
Sıva Altı Kasa (3M)
Mounting Casing (3M)



2400 500 0417
Sıva Altı Kasa (4M)
Mounting Casing (4M)



2400 500 0717
Sıva Altı Kasa (7M)
Mounting Casing (7M)

KASA • BOX



2400 812 1215
Sıva Altı Kasa (2M)
Mounting Casing (2M)



2400 812 1315
Sıva Altı Kasa (3M)
Mounting Casing (3M)



2400 812 1415
Sıva Altı Kasa (4M)
Mounting Casing (4M)



2400 812 1715
Sıva Altı Kasa (7M)
Mounting Casing (7M)



2400 813 1315
Alçıpan Kasa (3M)
Drywall casing (3M)



2400 813 1415
Alçıpan Kasa (4M)
Drywall casing (4M)

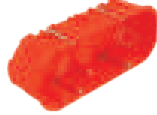

2400 813 1715
Alçıpan Kasa (7M)
Drywall casing (7M)



2400 818 0011
Sıva altı bağlantı aparatı
Distance element for mounting boxes

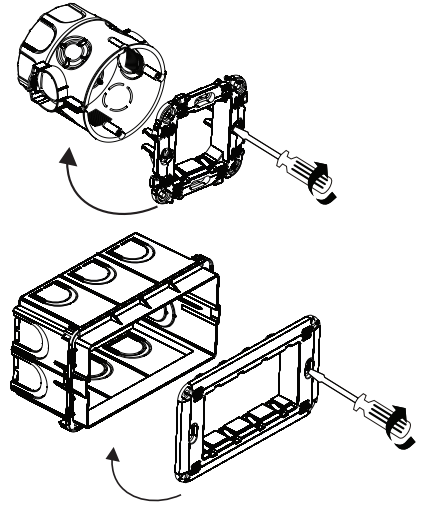

KOMBİNASYON • COMBINATION

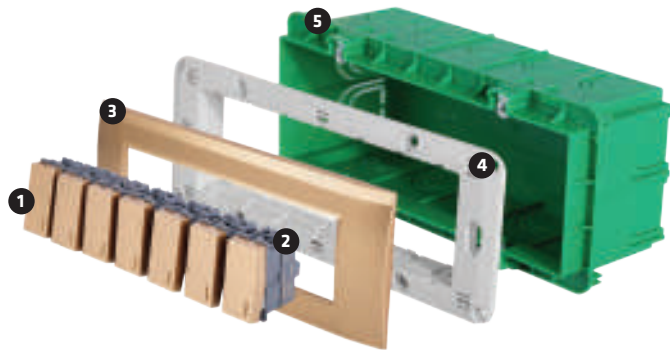

- 1 2410 715 0180 Işıklı anahtar (1M) Illu. switch button
- 2 2400 701 0200 Anahtar Switch
- 3 2430 800 1380 Stella antik altın çerçeve (3X2M) Stella antique gold frame
- 4 2400 500 0717 Taşıyıcı kaide (7M) Mouting frame (7M)
- 5 2400 812 0715 Sıva altı kasa (7M) Mouting casing (7M)

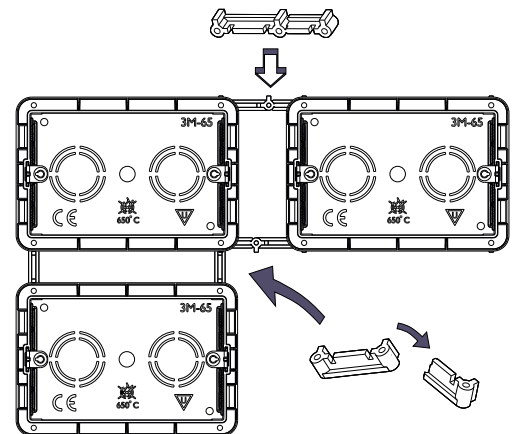

MODÜLER SİSTEM

Modular System



Modüler sistem anahtarlar, estetikliği ve fonksiyonelliği bir arada sunan modern elektrik anahtar çözümleridir. Bu sistemler, kullanıcıların ihtiyaçlarına göre farklı modüller ekleyebilmesine veya çıkarabilmesine olanak tanır.

Modular system switches are modern electrical switch solutions that offer aesthetics and functionality together. These systems allow users to add or remove different modules according to their needs.



MODULAR
Stella

Stella

ÇERÇEVE FRAME

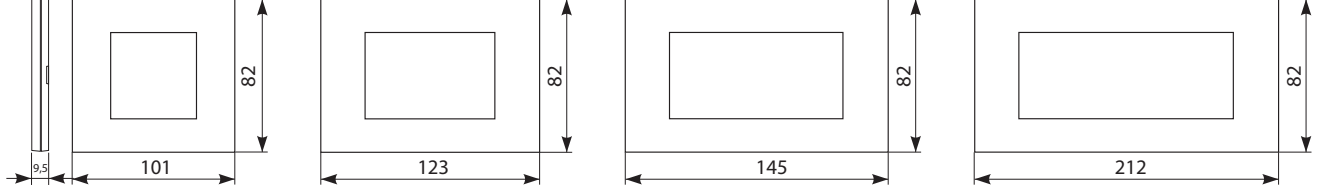

STELLA ÇERÇEVE • STELLA FRAME

Kod/Code	Ürün Tanımı	Description
2440 800 12XX	2M ÇERÇEVE	2M FRAME
2440 800 13XX	3M ÇERÇEVE	3M FRAME
2440 800 14XX	4M ÇERÇEVE	4M FRAME
2440 800 17XX	7M ÇERÇEVE	7M FRAME
2430 800 12XX	2X2M ÇERÇEVE	2X2M FRAME
2430 800 13XX	3X2M ÇERÇEVE	3X2M FRAME

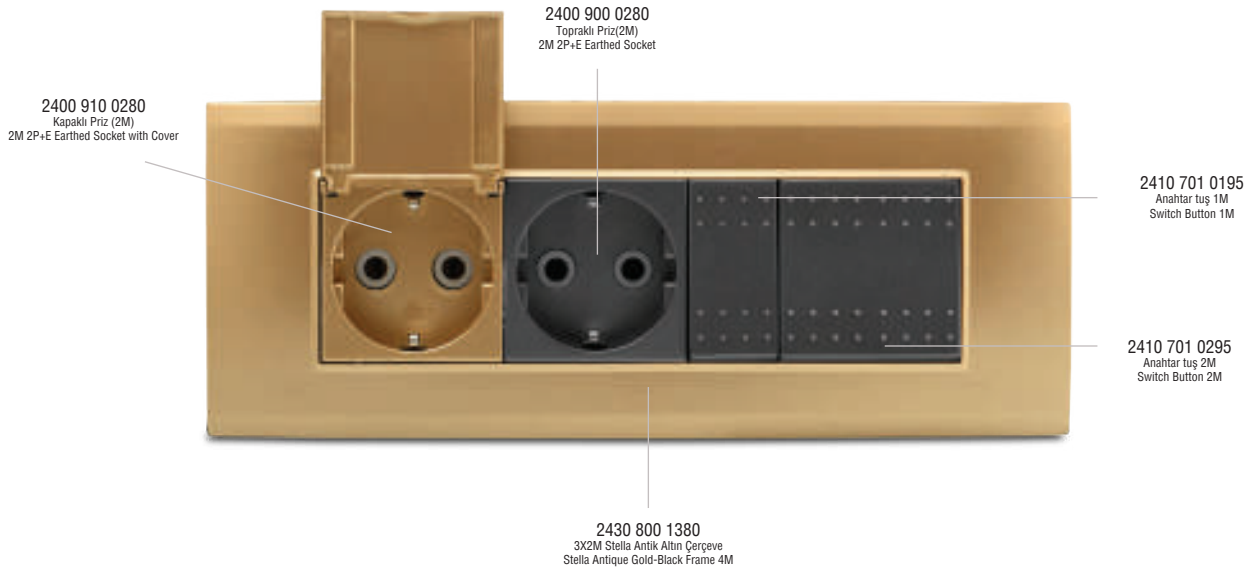



ÇERÇEVE FRAME

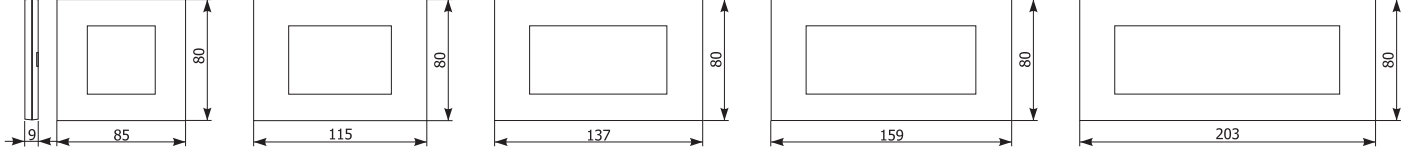

ALESSA ÇERÇEVE • ALESSA FRAME

Kod/Code	Ürün Tanımı	Description
2420 8XX 12XX	2M ÇERÇEVE	2M FRAME
2420 8XX 13XX	3M ÇERÇEVE	3M FRAME
2420 8XX 14XX	4M ÇERÇEVE	4M FRAME
2420 8XX 17XX	7M ÇERÇEVE	7M FRAME
2450 8XX 12XX	2X2M ÇERÇEVE	2X2M FRAME
2450 8XX 13XX	3X2M ÇERÇEVE	3X2M FRAME

2420 811 1480
Alessa Antik Altın Çerçeve 4M
Alessa Antique Gold-Black 4M



2410 701 0180
Anahtar Tuş
Switch Button

2410 715 0180
Işıklı Anahtar Tuş
Ilu. Switch Button



Kutuda daha fazla anahtar kurulum seçeneği.

2, 3 ve 4'lü grup anahtarlar için dahili köprü.

Kalın kablolar için daha fazla uyumluluk sağlayan büyük açıklıklar.

UV korumasını destekleyen, çok güçlü bir malzeme olan polikarbonat Lexan plastikten yapılmıştır.

More options for switch installation on the box.

Built-in internal bridge for 2,3 & 4 gang switches.

Big openings which give more compatibility for thick wires.

Made of polycarbonate Lexan plastic which is very strong material and support UV protection.

LIVA



"Güvenilir ve Şık Çözümler"
"Reliable and Stylish Solutions"

DEKORSUZ • UNDECORATED



2290 121 02XX

Kör Kapak
Blind Cover



2290 001 02XX

Tekli Anahtar Geniş Düğmeli 15A
Single Key With Large Switch 15A



2290 002 02XX

İkili Anahtar Geniş Düğmeli 15A
Dual Switch with Large Button 15A

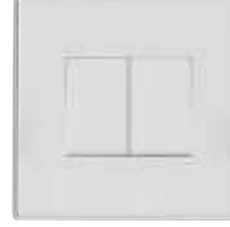

2290 002 01XX

İkili Anahtar Küçük Düğmeli 15A
Dual Key with Small Switch 15A

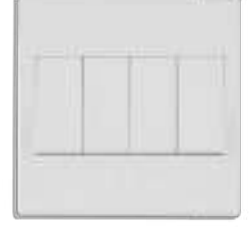

2290 014 01XX

Dörtlü Anahtar Düğmeli 15A
Quadruplet Switch With Button 15A



2290 101 01XX

Tekli Priz 13A
Single Socket 13A



2290 205 11XX

Çift Kutuplu Anahtarlı Priz 13A
Dual Pole Switched Socket 13A



2290 110 01XX

Tek Kutuplu Lambalı Anahtarlı Priz 13A
Single Pole Switch Socket with Lamp 13A



2290 915 01XX

Tek Kutuplu Lambalı Ünliversal Anahtarlı Priz 16A
Single Pole Universal Switch Socket with Lamp 16A



2290 010 01XX

Anahtar 20A
Switch 20A



2290 172 01XX

Tekli Uydu Prizi F Dişi
Single Satellite Socket F Thread



2290 136 01XX

Tekli Data Prizi CAT5
Single Data Socket CAT5



2290 125 01XX

Tekli Telefon Prizi CAT3
Single Telephone Socket CAT3

DEKORLU • DECORATED



2291 001 02XX

Tekli Anahtar Geniş Düğmeli 15A
Single Switch with Large Button 15A



2291 002 02XX

İkili Anahtar Geniş Düğmeli 15A
Dual Switch with Large Button



2291 001 01XX

Tekli Anahtar Küçük Düğmeli 15A
Single Switch with Small Button 15A



2291 014 01XX

Dörtlü Anahtar 15A
Quadruplet Switch 15A



RENK SEÇENEKLERİ COLOR OPTIONS

NATUREL
NATURAL



XX:01 Beyaz White



XX:80 Siyah Black



XX:86 Antrasit Anthracite

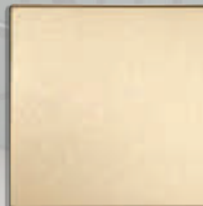

XX:81 Antik Altın Antique Gold



XX:84 Saten Beyaz Satin White



LIVA

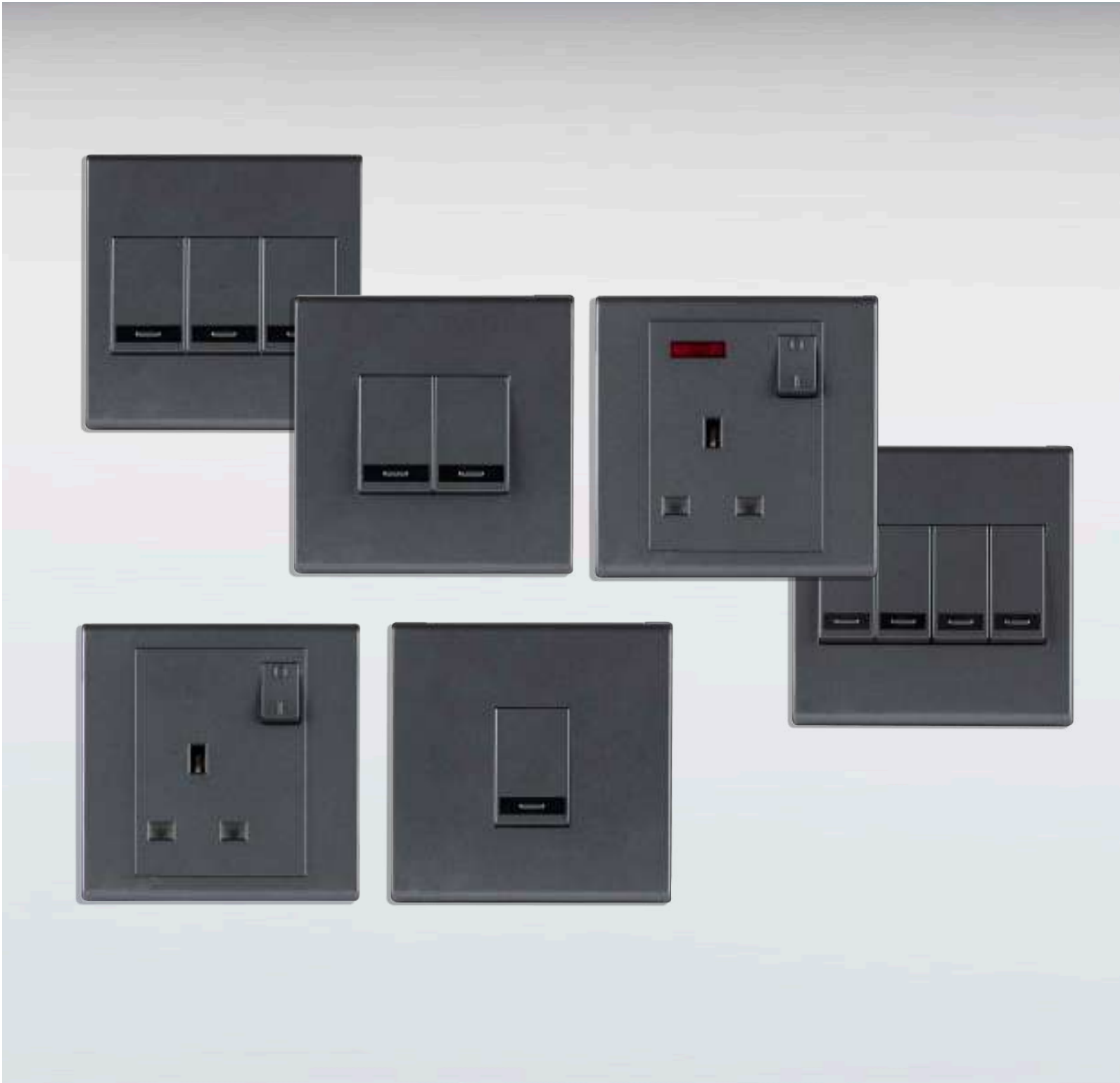





MEKANİZMA + TUŞ ÜRÜN LİSTESİ • MECHANISM + SWITCH PRODUCT LIST

Kod Code	Ürün Tanımı	Description	Kutu / Koli Box / Parcel	Birim Ağırlık/Hacim Unit Weight/Volume	Kutu Ağırlık/Hacim Box Weight/Volume
2290 001 01XX	LİVA DEKORSUZ TEKLİ ANAHTAR KÜÇÜK DÜĞMELİ 15A	UNDECORATED SINGLE KEY WITH SMALL SWITCH 15A	10 /100	0,105 / 0,00032	1,05 / 0,00324
2290 001 02XX	LİVA DEKORSUZ TEKLİ ANAHTAR GENİŞ DÜĞMELİ 15A	UNDECORATED SINGLE KEY WITH LARGE SWITCH 15A	10 /100	0,105 / 0,00032	1,05 / 0,00324
2290 002 01XX	LİVA DEKORSUZ İKİLİ ANAHTAR KÜÇÜK DÜĞMELİ 15A	UNDECORATED DUAL KEY WITH SMALL SWITCH 15A	10 /100	0,105/ 0,00032	1,05 / 0,00324
2290 002 02XX	LİVA DEKORSUZ İKİLİ ANAHTAR GENİŞ DÜĞMELİ 15A	UNDECORATED DUAL SWITCH WITH LARGE BUTTON 15A	10 /100	0,105 / 0,00032	1,05 / 0,00324
2290 003 01XX	LİVA DEKORSUZ VAVİEN KÜÇÜK DÜĞMELİ 15A	UNDECORATED VAVIEN WITH SMALL SWITCH 15A	10 /100	0,105 / 0,00032	1,05 / 0,00324
2290 003 02XX	LİVA DEKORSUZ VAVİEN GENİŞ DÜĞMELİ 15A	UNDECORATED VAVIEN WITH LARGE SWITCH 15A	10 /100	0,105 / 0,00032	1,05 / 0,00324
2290 004 01XX	LİVA DEKORSUZ KOMİTATÖR VAVİEN KÜÇÜK DÜĞMELİ 15A	UNDECORATED COMMUTATOR VAVIEN WITH SMALL BUTTON 15A	10 /100	0,105 / 0,00032	1,05 / 0,00324
2290 004 02XX	LİVA DEKORSUZ KOMİTATÖR VAVİEN GENİŞ DÜĞMELİ 15A	UNDECORATED COMMUTATOR VAVIEN WITH LARGE BUTTON 15A	10 /100	0,105 / 0,00032	1,05 / 0,00324
2290 006 01XX	LİVA DEKORSUZ JALUZİ ANAHTAR DÜĞMELİ 15A	UNDECORATED VENETIAN BLINDS WITH SWITCH BUTTON 15A	10 /100	0,105 / 0,00032	1,05 / 0,00324
2290 007 01XXZ	LİVA DEKORSUZ ZİL BUTONU KÜÇÜK DÜĞMELİ 15A	UNDECORATED BELL RING BUTTON WITH SMALL SWITCH 15A	10 /100	0,105 / 0,00032	1,05 / 0,00324
2290 007 02XXZ	LİVA DEKORSUZ ZİL BUTONU GENİŞ DÜĞMELİ 15A	UNDECORATED BELL RING BUTTON WITH LARGE SWITCH 15A	10 /100	0,105 / 0,00032	1,05 / 0,00324
2290 008 01XX	LİVA DEKORSUZ DEVİYATÖR DÜĞMELİ 15A	UNDECORATED DEVIATOR WITH BUTTON 15A	10 /100	0,105 / 0,00032	1,05 / 0,00324
2290 009 01XX	LİVA DEKORSUZ ÜÇLÜ ANAHTAR DÜĞMELİ 15A	UNDECORATED TRIPLE SWITCH WITH BUTTON 15A	10 /100	0,105 / 0,00032	1,05 / 0,00324
2290 010 01XX	LİVA ANAHTAR 20A	SWITCH 20A	10 /100	0,105 / 0,00032	1,05 / 0,00324
2290 011 01XX	LİVA A/C KLİMA ANAHTARI 45A	A/C AIR CONDITIONER SWITCH 45A	10 /100	0,105 / 0,00032	1,05 / 0,00324
2290 011 2101	LİVA A/C KLİMA ANAHTARI 45A, 7*14	A/C AIR CONDITIONER SWITCH 45A, 7*14	5 /50	0,146 / 0,00051	0,73 / 0,00257
2290 014 01XX	LİVA DEKORSUZ DÖRTLÜ ANAHTAR DÜĞMELİ 15A	UNDECORATED QUADRUPLER SWITCH WITH BUTTON 15A	10/ 100	0,105 / 0,00032	1,05 / 0,00324
2290 014 11XX	LİVA DEKORSUZ DÖRTLÜ ANAHTAR DÜĞMELİ 15A, 7*14	UNDECORATED QUADRUPLER SWITCH WITH BUTTON 15A, 7*14	5/50	0,146 / 0,00051	0,73 / 0,00257
2290 016 11XX	LİVA DEKORSUZ ALTILI ANAHTAR DÜĞMELİ 15A, 7*14	UNDECORATED SEXTETTE SWITCH WITH BUTTON 15A, 7*14	5/50	0,146 / 0,00051	0,73 / 0,00257
2290 039 01XX	LİVA DEKORSUZ ÜÇLÜ VAVİEN DÜĞMELİ 15A	UNDECORATED TRIPLE VAVIEN WITH BUTTON 15A	10/100	0,105 / 0,00032	1,05 / 0,00324
2290 043 01XX	LİVA TEKLİ FAN 300W	SINGLE FAN 300W	8/80	0,105 / 0,00032	0,84 / 0,00259
2290 045 01XX	LİVA TEKLİ DİMMER 300W	SINGLE DIMMER 300W	8/80	0,105 / 0,00032	0,84 / 0,00259
2290 055 01XX	LİVA USB KONNEKTÖR PRİZİ	USB CONNECTOR SOCKET	10 /100	0,105 / 0,00032	1,05 / 0,00324
2290 057 01XX	LİVA HDMI KONNEKTÖR PRİZİ	HDMI CONNECTOR SOCKET	10 /100	0,105 / 0,00032	1,05 / 0,00324
2290 059 01XX	LİVA HDMI KONNEKTÖR+USB KONNEKTÖR PRİZİ	HDMI CONNECTOR+USB CONNECTOR SOCKET	10 /100	0,105 / 0,00032	1,05 / 0,00324
2290 100 01XX	LİVA TEK KUTUPLU ANAHTARLI PRİZ 13A	SINGLE POLE SWITCHED SOCKET 13A	10 /100	0,105 / 0,00032	1,05 / 0,00324
2290 101 01XX	LİVA TEKLİ PRİZ 13A	SINGLE SOCKET 13A	10 /100	0,105 / 0,00032	1,05 / 0,00324
2290 105 01XX	LİVA ÇİFT KUTUPLU ANAHTARLI PRİZ 13A	DUAL POLE SWITCHED SOCKET 13A	10 /100	0,105 / 0,00032	1,05 / 0,00324
2290 110 01XX	LİVA TEK KUTUPLU LAMBALI ANAHTARLI PRİZ 13A	SINGLE POLE SWITCH SOCKET WITH LAMP 13A	10 /100	0,105 / 0,00032	1,05 / 0,00324
2290 115 01XX	LİVA ÇİFT KUTUPLU LAMBALI ANAHTARLI PRİZ 13A	DUAL POLE SWITCH SOCKET WITH LAMP 13A	10 /100	0,105 / 0,00032	1,05 / 0,00324
2290 121 02XX	LİVA KÖR KAPAK	BLIND COVER	20/200	0,077 / 0,00016	1,54 / 0,00324
2290 122 01XX	LİVA 45A BAĞLANTI ÜNİTESİ-YENİ TASARIM	45A INTERFACE UNIT-NEW DESIGN	10 /100	0,105 / 0,00032	1,05 / 0,00324
2290 125 01XX	LİVA TEKLİ TELEFON PRİZİ CAT-3	SINGLE TELEPHONE SOCKET CAT-3	10 /100	0,105 / 0,00032	1,05 / 0,00324
2290 126 01XX	LİVA ÇİFTLİ TELEFON PRİZİ CAT-3	DUAL TELEPHONE SOCKET CAT-3	10 /100	0,105 / 0,00032	1,05 / 0,00324
2290 136 01XX	LİVA TEKLİ DATA PRİZİ CAT-5	SINGLE DATA SOCKET CAT-5	10 /100	0,105 / 0,00032	1,05 / 0,00324
2290 138 01XX	LİVA ÇİFTLİ DATA PRİZİ (CAT-5)	DUAL DATA SOCKET (CAT-5)	10 /100	0,105 / 0,00032	1,05 / 0,00324
2290 139 01XX	LİVA DATA PRİZİ (CAT-5)+ TELEFON (CAT-3)	DATA SOCKET (CAT-5)+ TELEPHONE (CAT-3)	10 /100	0,105 / 0,00032	1,05 / 0,00324
2290 146 01XX	LİVA UYDU PRİZİ (SAT)+TELEFON (CAT-3)	SATELLITE SOCKET (SAT)+PHONE (CAT-3)	10 /100	0,105 / 0,00032	1,05 / 0,00324
2290 148 01XX	LİVA DATA PRİZİ (CAT-5)+ UYDU (F DİŞİ)	DATA SOCKET (CAT-5)+ SATELLITE (F THREAD)	10 /100	0,105 / 0,00032	1,05 / 0,00324
2290 172 01XX	LİVA TEKLİ UYDU PRİZİ (F DİŞİ)	SINGLE SATELLITE SOCKET (F THREAD)	10 /100	0,105 / 0,00032	1,05 / 0,00324
2290 177 01XX	LİVA ÇİFTLİ UYDU PRİZİ (F DİŞİ)	DUAL SATELLITE SOCKET (F THREAD)	10 /100	0,105 / 0,00032	1,05 / 0,00324
2290 201 11XX	LİVA ÇİFTLİ PRİZ 13A, 7*14	DUAL SOCKET 13A, 7*14	5/50	0,146 / 0,00051	0,73 / 0,00257
2290 205 11XX	LİVA ÇİFT KUTUPLU ÇİFT ANAHTARLI PRİZ 13A, 7*14	DUAL POLE DUAL SWITCH SOCKET 13A, 7*14	5/50	0,146 / 0,00051	0,73 / 0,00257
2290 245 01XX	LİVA ÇİFTLİ DİMMER 300W+300W	DUAL DIMMER 300W+300W	8/80	0,105 / 0,00032	0,84 / 0,00259
2290 252 01XX	LİVA SES JAK PRİZİ	AUDIO JACK SOCKET	10 /100	0,105 / 0,00032	1,05 / 0,00324
2290 256 01XX	LİVA SES JAK+DATA PRİZİ (CAT-5)	AUDIO JACK+DATA SOCKET (CAT-5)	10 /100	0,105 / 0,00032	1,05 / 0,00324
2290 900 01XX	LİVA MODÜLER ALMAN PRİZİ 16A	MODULAR GERMAN SOCKET 16A	8/80	0,105 / 0,00041	0,84 / 0,00324
2290 901 01XX	LİVA MODÜLER PRİZ 13A	MODULAR SOCKET 13A	10 /100	0,105 / 0,00032	1,05 / 0,00324

Kod Code	Ürün Tanımı	Description	Kutu / Koli Box / Parcel	Birim Ağırlık/Hacim Unit Weight/Volume	Kutu Ağırlık/Hacim Box Weight/Volume
2290 915 01XX	LİVA TEK KUTUPLU LAMBALI UNİVERSAL ANAHTARLI PRİZ 16A	SINGLE POLE UNIVERSAL SWITCH SOCKET WITH LAMP 16A	10 / 100	0,105 / 0,00032	1,05 / 0,00324
2290 925 01XX	LİVA TEK KUTUPLU UNİVERSAL ANAHTARLI PRİZ 16A	SINGLE POLE UNIVERSAL SWITCH SOCKET 16A	10 / 100	0,105 / 0,00032	1,05 / 0,00324
2290 935 01XX	LİVA MODÜLER UNİVERSAL PRİZ 16A	MODULAR UNIVERSAL SOCKET 16A	10 / 100	0,105 / 0,00032	1,05 / 0,00324
2291 001 01XX	LİVA DEKORLU TEKLİ ANAHTAR KÜÇÜK DÜĞMELİ 15A	DECORATED SINGLE SWITCH WITH SMALL BUTTON 15A	10 / 100	0,105 / 0,00032	1,05 / 0,00324
2291 001 02XX	LİVA DEKORLU TEKLİ ANAHTAR GENİŞ DÜĞMELİ 15A	DECORATED SINGLE SWITCH WITH LARGE BUTTON 15A	10 / 100	0,105 / 0,00032	1,05 / 0,00324
2291 002 01XX	LİVA DEKORLU İKİLİ ANAHTAR KÜÇÜK DÜĞMELİ 15A	DECORATED DUAL SWITCH WITH SMALL BUTTON 15A	10 / 100	0,105 / 0,00032	1,05 / 0,00324
2291 002 02XX	LİVA DEKORLU İKİLİ ANAHTAR GENİŞ DÜĞMELİ 15A	DECORATED DUAL SWITCH WITH LARGE BUTTON 15A	10 / 100	0,105 / 0,00032	1,05 / 0,00324
2291 003 01XX	LİVA LİVA DEKORLU VAVİEN KÜÇÜK DÜĞMELİ 15A	DECORATED VAVIEN WITH SMALL BUTTON 15A	10 / 100	0,105 / 0,00032	1,05 / 0,00324
2291 003 02XX	LİVA DEKORLU VAVİEN GENİŞ DÜĞMELİ 15A	DECORATED VAVIEN WITH LARGE BUTTON 15A	10 / 100	0,105 / 0,00032	1,05 / 0,00324
2291 004 01XX	LİVA DEKORLU KOMİTATÖR VAVİEN KÜÇÜK DÜĞMELİ 15A	DECORATED COMMUTATOR VAVIEN WITH SMALL BUTTON 15A	10 / 100	0,105 / 0,00032	1,05 / 0,00324
2291 004 02XX	LİVA DEKORLU KOMİTATÖR VAVİEN GENİŞ DÜĞMELİ 15A	DECORATED COMMUTATOR VAVIEN WITH LARGE BUTTON 15A	10 / 100	0,105 / 0,00032	1,05 / 0,00324
2291 006 01XX	LİVA DEKORLU JALUZİ ANAHTAR	DECORATED BLINDS SWITCH	10 / 100	0,105 / 0,00032	1,05 / 0,00324
2291 007 01XXZ	LİVA DEKORLU ZİL BUTONU KÜÇÜK DÜĞMELİ 15A	DECORATED BELL RING BUTTON WITH SMALL BUTTON 15A	10 / 100	0,105 / 0,00032	1,05 / 0,00324
2291 007 02XXZ	LİVA DEKORLU ZİL BUTONU GENİŞ DÜĞMELİ 15A	DECORATED BELL RING BUTTON WITH LARGE BUTTON 15A	10 / 100	0,105 / 0,00032	1,05 / 0,00324
2291 008 01XX	LİVA DEKORLU DEVIATÖR DÜĞMELİ 15A	DECORATED DEVIATOR WITH BUTTON 15A	10 / 100	0,105 / 0,00032	1,05 / 0,00324
2291 009 01XX	LİVA DEKORLU ÜÇLÜ ANAHTAR 15A	DECORATED TRIPLE SWITCH 15A	10 / 100	0,105 / 0,00032	1,05 / 0,00324
2291 014 01XX	LİVA DEKORLU DÖRTLÜ ANAHTAR 15A	DECORATED QUADRUPLLET SWITCH 15A	10 / 100	0,105 / 0,00032	1,05 / 0,00324
2291 014 11XX	LİVA DEKORLU DÖRTLÜ ANAHTAR 15A, 7*14	DECORATED QUADRUPLLET SWITCH 15A, 7*14	5 / 50	0,146 / 0,00051	0,73 / 0,00257
2291 016 11XX	LİVA DEKORLU ALTILI ANAHTAR 15A, 7*14	DECORATED SEXTETTE SWITCH 15A, 7*14	5 / 50	0,146 / 0,00051	0,73 / 0,00257
2291 039 01XX	LİVA DEKORLU ÜÇLÜ VAVİEN 15A	DECORATED TRIPLE VAVIEN 15A	10 / 100	0,105 / 0,00032	1,05 / 0,00324



ANAHTAR PRİZ GRUBU SWITCHES & SOCKETS GROUP

Mükemmel tasarımı dış görünümü ve yenilenen iç mekanizmasıyla kusursuz olan bu ürün, estetik ve işlevselliği bir araya getiriyor.

Perfect with its perfectly designed exterior and renewed internal mechanism. This product combines aesthetics and functionality.

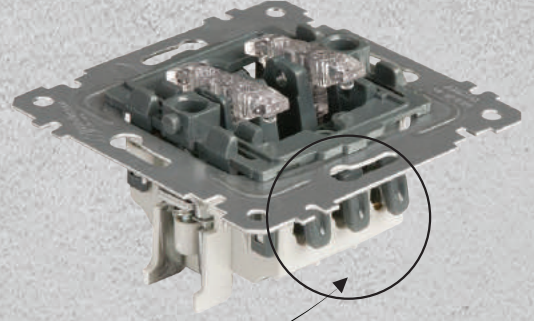
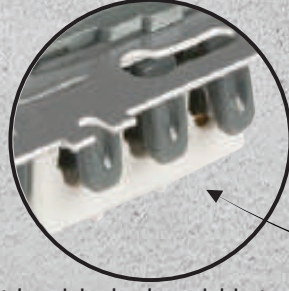

Klipsli mekanizma

Easy connection mechanism

- Kolay Bağlantı : Kablo bağlantıları için herhangi bir tornavida veya şarjlı cihaz gerektirmeden kablo montajının yapılabilmesi,
- Vidasız kablo bağlantısı özelliğiyle montaj süresini kısaltması,
- Beton duvar, Kasa, Alçıpan duvar, Ahşap blok vb. her türlü uygulama yüzeyleri için çeşitli montaj noktaları,
- Easy Connection: The ability to perform cable installation without the need for any screwdriver or power tool.
- Reducing installation time with the feature of screwless cable connection.
- Various mounting points for all types of application surfaces such as concrete wall, casing, drywall, wooden block, etc.

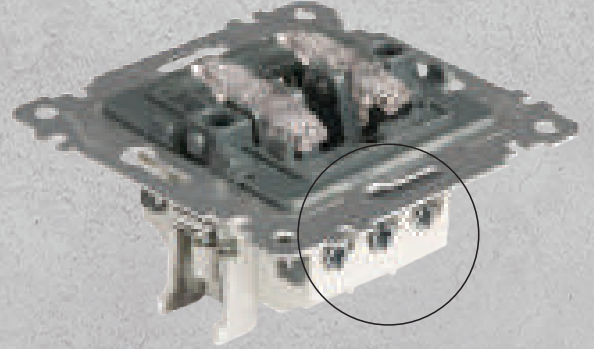

Vidalı mekanizma

Mechanism with screw

1. Güçlü Sabitleme: Vidalı mekanizma, priz duvara veya montaj kutusuna sıkıca sabitlenmesini sağlar. Vidalar, priz sağlam bir şekilde yerinde kalmasını ve kullanım sırasında gevşememesini temin eder.
 2. Güvenlik: Vidalar, priz montajını daha güvenli hale getirir. Sabit bir şekilde monte edilmiş bir priz, elektriksel bağlantıların sağlam ve güvenli olmasını sağlar, böylece elektriksel arızaların ve kazaların önüne geçilir.
 3. Dayanıklılık: Vidalı montaj, klipsli sistemlere göre daha dayanıklıdır. Uzun süreli kullanımda priz yerinde sabit kalmasını ve dış etkenlere karşı daha dirençli olmasını sağlar.
 4. Kolay Bakım ve Onarım: Vidalı mekanizma sayesinde, prizlerin bakım ve onarımı daha kolaydır. Prizi yerinden çıkarmak ve iç mekanizmasına erişmek için vidaları sökmek yeterlidir. Bu, elektrikçilerin ve teknisyenlerin işini kolaylaştırır.
 5. Uyumluluk: Çoğu duvar ve montaj kutusu vidalı mekanizmaya uyumlu olarak tasarlanmıştır. Bu nedenle vidalı prizler, geniş bir yelpazede kullanılabilir ve çeşitli montaj yüzeylerine uyarlanabilir.
1. Strong Fixation: The screw mechanism ensures that the socket is securely fastened to the wall or mounting box. The screws guarantee that the socket remains firmly in place and does not loosen during use.
 2. Safety: Screws make the installation of the socket more secure. A firmly mounted socket ensures that electrical connections are solid and safe, preventing electrical faults and accidents.
 3. Durability: Screw-mounted systems are more durable than clip-based systems. They ensure the socket remains fixed in place over long-term use and is more resistant to external factors.
 4. Easy Maintenance and Repair: The screw mechanism makes socket maintenance and repair easier. To remove the socket and access its internal mechanism, simply unscrew the screws. This simplifies the work for electricians and technicians.
 5. Compatibility: Most walls and mounting boxes are designed to be compatible with screw mechanisms. Therefore, screw-based sockets can be widely used and adapted to various mounting surfaces.

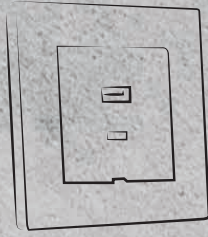

Type C USB Prizler, USB ve Type-C bağlantı noktalar
Type C USB Sockets, data socket equipped with USB and Type-C portsla donatılmış veri prizi

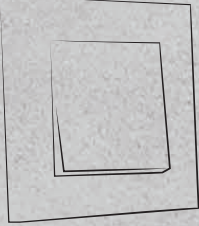

Anahtarlar, Vidalı ve klipsli seçenekleriyle donatılmış anahtarlar
Switches, switches equipped with both screw and clip options

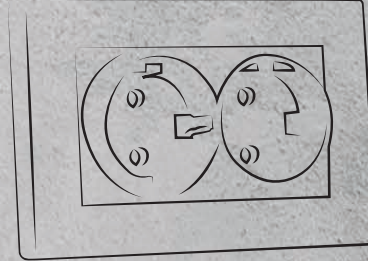

İkili Priz
Birden fazla cihazın aynı anda kullanılmasını sağlayarak priz sayısını azaltır.
Double Socket
Reduces the number of sockets by allowing multiple devices to be used simultaneously.

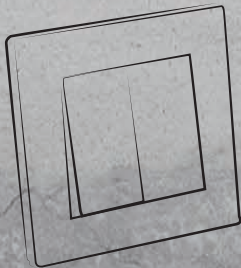

Komütatör Anahtar
Komütatörler, iki lamba veya lamba grubunun; koridorlar, merdivenler ve giriş alanları gibi yerlerde ışıkları aynı yerden kontrol edilmesine imkan tanır.
Commutator Switch
Commutators allow the control of two lamps or groups of lamps from the same location, in areas such as corridors, staircases, and entryways.

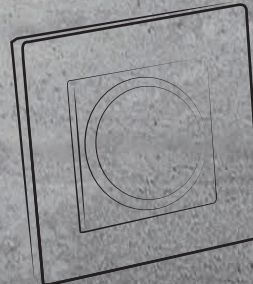

Dimmer
Aydınlatma sistemlerindeki esneklik ve kontrol imkanıyla çeşitli alanlarda Dimmer
It is widely used in various areas with its flexibility and control in lighting systems.



KALİTE & GÜVENLİK
QUALITY & SECURITY



Ritä

Dayanıklı malzemeler ve ileri teknoloji ile uzun ömürlü ve güvenli çözümler.

Modern ve şık tasarımlarıyla her türlü iç mekana uyum sağlar.

Çeşitli renk ve model seçenekleri

Dekorasyon tercihlerine uygun alternatifler.

Kolay montaj ve kullanım özellikleri

Güvenliđi ve konforu bir arada sunarak yaşam alanlarını daha işlevsel hale getirir.

Long-lasting and safe solutions with durable materials and advanced technology.

It fits into any interior with its modern and stylish designs.

Various color and model options

Alternatives suitable for decoration preferences.

Easy assembly and usage features

It makes living spaces more functional by offering security and comfort together.



ANAHTAR GRUBU VİDALI TİP SWITCH GROUP (WITH SCREW)



2220 401 02XX
Anahtar
Oneg. One Way Switch



2220 402 02XX
Komütatör
Twog. One Way Control



2220 403 02XX
Vavien (iki Yollu Anahtar)
Oneg. Two Way Switch



2220 404 02XX
Komütatör Vavien
Two Gang Two Way Switch

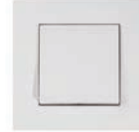

2220 405 02XX
Çift Kutuplu Anahtar
Oneg. One Way Dp



2220 406 02XX
Jaluzi Anahtarı
Blind Switch -W/Spring



2220 407 02XX
Çağırma
One Gang One Way Control



2220 407 02XXX
Kapı Otomatığı Anahtarı
Door Switch



2220 407 02XXZ
Zil Anahtarı
Ring Switch



2220 408 02XX
Deviyatör(Ara Vavien)
Oneg. Intermediate-Deviator



2220 409 02XX
Üçlü Anahtar
3 Gang Switch



2220 411 02XX
Şofben Anahtarı
Heater Switch



2220 415 02XX
Işıklı Anahtar (220V)
Illu.1g.1w.Swi. (220v)



2220 416 02XX
Işıklı Vavien (220V)
Illu.Oneg. Two Way (220v)



2220 417 02XX
Işıklı Çağırma (220V)
Illu.1g.1w.Cntrl (220v)



2220 418 02XX
Işıklı Etik. Anahtar (220V)
Illu.1g.1w.W/Lab. (220v)



2220 419 02XX
Işıklı Etik. Çağırma (220V)
I.1g.1w.Cntrlw/Lab. (220v)



2220 422 02XX
Işıklı Zil Etik. Çağırma (12V)
Illu.1g.1w.Cntrl (12v)



2220 425 02XX
Tek Tuşlu Jaluzi Anahtarı
(Vidalı)
Blind Switch (With Screw)



2220 426 02XX
Işıklı Komütatör
Illu.Twog. One Way Control

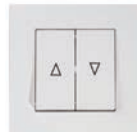

2220 436 02XX
Jaluzi Anahtarı (Yaysız - Vidalı)
Blind Switch (With Screw)



2220 401 01XX
Anahtar
Oneg. One Way Switch



2220 402 01XX
Komütatör
Twog. One Way Control

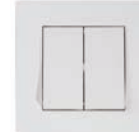

2220 403 01XX
Vavien (iki Yollu Anahtar)
Oneg. Two Way Switch



2220 404 01XX
Komütatör Vavien
Two Gang Two Way Switch



2220 405 01XX
Çift Kutuplu Anahtar
Oneg. One Way Dp



2220 406 01XX
Jaluzi Anahtarı
Blind Switch -W/Spring



2220 407 01XX
Çağırma
One Gang One Way Control



2220 407 01XXX
Kapı Otomatığı Anahtarı
Door Switch



2220 407 01XXZ
Zil Anahtarı
Ring Switch



2220 408 01XX
Deviyatör(Ara Vavien)
Oneg. Intermediate-Deviator



2220 409 01XX
Üçlü Anahtar
3 Gang Switch



2220 415 01XX
Işıklı Anahtar (220V)
Illu.1g.1w.Swi. (220v)



2220 416 01XX
Işıklı Vavien (220V)
Illu.Oneg. Two Way (220v)



2220 417 01XX
Işıklı Çağırma (220V)
Illu.1g.1w.Cntrl (220v)



2220 418 01XX
Işıklı Etik. Anahtar (220V)
Illu.1g.1w.W/Lab. (220v)



2220 419 01XX
Işıklı Etik. Çağırma (220V)
I.1g.1w.Cntrlw/Lab. (220v)



2220 422 01XX
Işıklı Zil Etik. Çağırma (12V)
Illu.1g.1w.Cntrl (12v)



2220 426 01XX
Işıklı Komütatör
Illu.Twog. One Way Switch

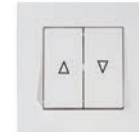

2220 436 01XX
Jaluzi Anahtarı (Yaysız - Klipsli)
Blind Switch (Without Screw)



DİMMER GRUBU DIMMER GROUP

2220 440 02XX
RL Işıklı Dimmer 600W
Rotary Dimmer 600W



2220 444 02XX
RL Işıklı Dimmer 1000W
Rotary Dimmer 1000W



2220 447 02XX
Mekk+Tuş RC Dimmer 325W
RC Dimmer 325W



ELEKTRONİK GRUBU ELECTRONICS GROUP

2220 450 01XX
Energy Saver G.sız Işıklı
Energy Saver Not Delay Illu.



2220 452 01XX
Energy Saver Geçikmeli Işıklı
Energy Saver Delay Illu.



2220 470 02XX
Müzik Yayın Anahtarı
Audio Switch



2220 480 01XX
Hoparlör Priz
Speaker Socket



2220 485 02XX
Uyarı Zili
Warning Bell



2220 495 02XX
Hareket Sensörü
Motion Sensor



PRİZ GRUBU SOCKET GROUP



2220 600 02XX
Topraklı Priz
Earthed Socket



2220 601 02XX
Topraksız Priz
Non Earthed Socket



2220 605 02XX
Topraklı Priz (Ç.K.)
Earthed Socket (Child Prot.)



2220 606 02XX
Topraksız Priz (Ç.K.)
Non Eart. Soc. (Child Prot.)



2220 610 02XX
Kapaklı Topraklı Priz
Earthed Socket With Cover



2220 611 02XX
Kapaklı Topraklı Priz (Ç.K.)
Earthed Soc. Cover (Child Prot.)



2220 615 02XX
Ups (Fransız) Priz
Ups (French) Socket (Earthed)



2220 616 02XX
Ups (Fransız) Priz (Ç.K.)
Ups (French) Soc. Child Prot.



2220 617 02XX
Ups Kapaklı (Fransız) Priz
Ups (French) Soc. With Cover



2220 618 02XX
Ups Kapaklı (Fr.) Priz (Ç.K.)
Ups (French) Soc.W.Cover (C.P.)



2220 448 01XX
Tekli Usb Şarj Prizi
1*Usb Charger



2220 469 01XX
İkili Type-c Usb Şarj Prizi
Type-c Usb Charger



2220 200 02XX
İkili Topraklı Priz Porselen
Double Socket Earthed Porcelain



2220 201 02XX
İkili Topraksız Priz Porselen
Double Soc.Non Earthed Porcelain



2220 202 02XX
İkili Topraklı Priz
Double Socket Earthed



2220 203 02XX
İkili Topraksız Priz
Double Soc.Non Earthed



2220 215 02XX
İkili Ups Priz
Double Socket Ups



2220 629 02XX
Usb+Type C (2.4A) Topraklı Priz
Usb+Type C (2.4A) Earthed Socket



2220 619 01XX
İkili Usb (2.4A) Topraklı Priz
2*Usb (2.4A) Earthed Socket

**İLETİŞİM
GRUBU
COMMUNICATION
GROUP**



2220 125 01XX
Telefon Prizi 1Xrj12 (Cat3)
Phonesocket 1*Xrj12 (Cat3)



2220 126 01XX
Telefon Prizi 2Xrj12 (Cat3)
Telephone Soc.2xrj12



2220 128 01XX
Etiketli Tif Data Priz (Kon.süz)
Tif Data Soc.W/O Con. Label



2220 135 02XX
Data Prizi 1*Rj45 (Kon.süz)
Data Soc.1*Rj45w/Ocon.



2220 136 01XX
Data Prizi 1*Rj45 (Cat5e)
Data Soc.1*Rj45 (Cat5e)



2220 137 01XX
Data Prizi 2*Rj45 (Kon.süz)
Data Soc.2*Rj45w/Ocon.



2220 138 01XX
Data Prizi 2*Rj45 (Cat5e)
Data Soc.2*Rj45 (Cat5e)



2220 139 01XX
Tif Data Priz (Rj12 Cat3 + Cat5e)
Tif Data Soc.(Rj12 Cat5e)



2220 140 01XX
Data Prizi 1*Rj45 (Cat6)
Data Soc.1*Rj45 (Cat6)



2220 141 01XX
Data Prizi 2*Rj45 (Cat6)
Data Soc.2*Rj45 (Cat6)



2220 455 01XX
Data Prizi 1*Usb
Data Soc.1*Usb



2220 456 01XX
Data Prizi 2*Usb
Data Soc.2*Usb



2220 457 01XX
Data Prizi 1*Hdmi
Data Soc.1*Hdmi



2220 458 01XX
Data Prizi 2*Hdmi
Data Soc.2*Hdmi



2220 459 01XX
Data Prizi 1*Usb/1*Hdmi
Data Soc.1*Usb/1*Hdmi



2220 460 01XX
VGA Priz
Switch Vga Socket



2220 461 01XX
İki Çıkışlı Fiber Optik Priz
Two-Output Fiber Optic Socket



2220 121 02XX
Kör Kapak
Blind Cover White

**TV / SAT
GRUBU
TV / SAT
GROUP**



2220 156 02XX
Tv-Sat Prizi (Geçişli) 4dB/F Kon.
Tv-Sat Soc.Thr.4db/Fcon.



2220 157 02XX
Tv-Sat Prizi (Sonlu)
Tv-Sat Soc.(Dead End)



2220 166 01XX
Sat Prizi (Geçişli) 4dB/F Kon.
Sat Soc.(Through)4db/Fcon.



2220 167 01XX
Sat Prizi (Sonlu)
Sat Soc.(Dead End)



2220 170 01XX
Tv Prizi (Geçişli) 11DB
Tv Socket (Thr) 11db



2220 171 01XX
Tv Prizi (Sonlu)
Tv Soc.(Dead End) 11db



2220 172 01XX
Tv Prizi F Dişi
Tv Socket F Female

**ELEKTRONİK
ELECTRONIC**



2220 250 01XX
Mikrofon Priz 6.3
Microphone Socket 6.3



2220 251 01XX
RCA Priz
RCA Socket



2220 252 01XX
XLR 3,5 Ses Jakı
XLR 3,5 Audio Connector



2220 253 01XX
XLR Erkek Priz
XLR Male Socket



2220 254 01XX
XLR Dişi Priz
XLR Female Socket



2220 255 01XX
USB Printer Priz
USB Printer Socket



Rit 

Metallic

Őıklıđın ve Fonksiyonelliđin BuluŐtuđu Renkler
Colors Where Elegance and Functionality Meet



RENK SEÇENEKLERİ COLOR OPTIONS

NATUREL NATURAL



XX:01 Beyaz White

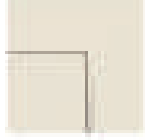

XX:02 Krem Cream

PASTEL PASTEL



XX:03 Gri Grey



XX:04 Kırmızı Red



XX:06 Turuncu Orange

METALİK METALLIC



XX:80 Antik Altın
Antique Gold



XX:82 İnoks
Inox

AHŞAP DESEN WOOD PATT

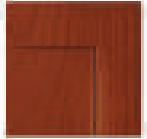

XX:56 Kiraz Cherry



XX:57 Ceviz Walnuts



XX:08 Sarı Yellow



XX:09 Lacivert
Navy Blue



XX:10 Yeşil Green



XX:84 Siyah Black



XX:85 Dore Dore



XX:11 Pembe Pink



XX:12 Mavi Blue



XX:25 Mor Purple

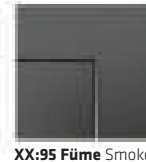

XX:95 Füme Smoked



XX:83 Titanyum
Titanium



XX:58 Meşe Oak



XX:86 Antrasit
Anthracite

YATAY ÇERÇEVELER HORIZONTAL FRAMES



2220 800 11XX
1'li Çerçeve 1 Gang frame



2220 800 12XX
2'li Çerçeve 2 Gang frame

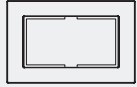

2220 820 12XX
2'li Priz Çerçeve
Double Socket frame



2220 800 13XX
3'li Çerçeve 3 Gang frame



2220 800 14XX
4'li Çerçeve 4 Gang frame

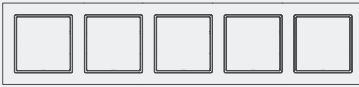

2220 800 15XX
5'li Çerçeve 5 Gang frame



2220 800 16XX
6'li Çerçeve 6 Gang frame

DİKEY ÇERÇEVELER VERTICAL FRAMES

2220 800 22XX
2'li Çerçeve
2 Gang frame

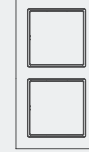

2220 800 23XX
3'li Çerçeve
3 Gang frame



2220 800 24XX
4'li Çerçeve
4 Gang frame



2220 800 25XX
5'li Çerçeve
5 Gang frame



2220 800 26XX
6'li Çerçeve
6 Gang frame

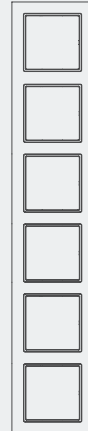

Bu ürün kodlarında XX çerçeve rengini belirtmektedir.
XX specify frame color for these products.

**"Kontrol Sizde,
Enerji Elinizde!"**

"Control in Your Hands, Power at Your Command!"



Ritã

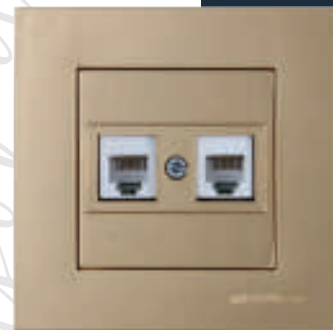

Konforun Seni Korumaya

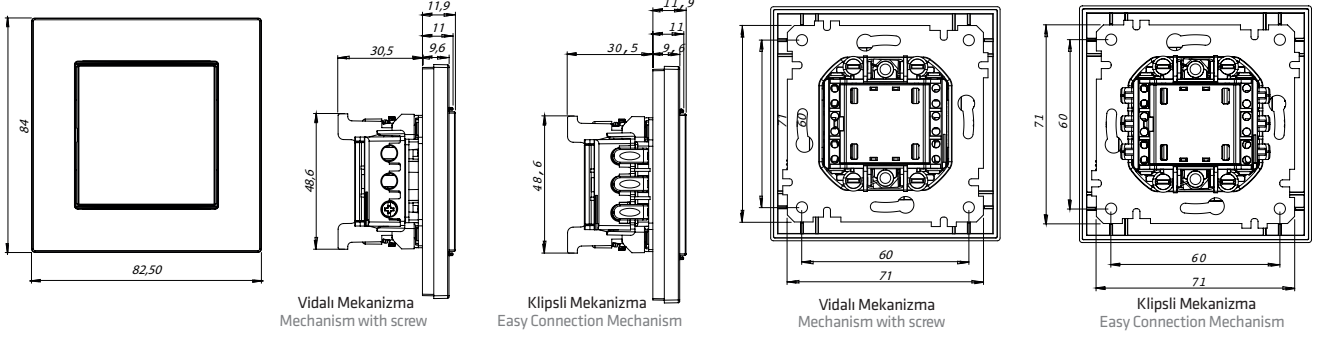

MEKANİZMA + TUŞ ÜRÜN LİSTESİ • MECHANISM + SWITCH PRODUCT LIST

ANAHTAR GRUBU VİDALI SWITCH GROUP (WITH SCREW)

KOD CODE	ÜRÜN TANIMI DESCRIPTION	KUTU BOX	KOLİ PARCEL	BİRİM AĞIRLIK UNIT WEIGHT	BİRİM HACİM UNIT VOLUME	KUTU AĞIRLIK BOX WEIGHT	KUTU HACİM BOX VOLUME
2200 401 02XX	RİTA MEK TUŞ ANAHTAR (VİDALI) RITA MEK ONE GANG ONE WAY SWITCH	12	120	0,085	0,00037	1,02	0,00444
2200 402 02XX	RİTA MEK TUŞ KOMÜTATÖR (VİDALI) TWO GANG ONE WAY SWITCH	12	120	0,087	0,00037	1,044	0,00444
2200 403 02XX	RİTA MEK TUŞ VAVİEN(İKİ YOLLU ANAHTAR)(VİDALI) ONE GANG TWO WAY SWITCH (VA-ET-VIENT)	12	120	0,087	0,00037	1,044	0,00444
2200 404 02XX	RİTA MEK TUŞ KOMÜTATÖR VAVİEN(VİDALI) TWO GANG TWO WAY SWITCH (COMMUTATOR VEAVIEN)	12	120	0,093125	0,00037	1,1175	0,00444
2200 405 02XX	RİTA MEK TUŞ ÇİFT KUTUPLU ANAHTAR(VİDALI) DOUBLE POLE SWITCH	12	120	0,089875	0,00037	1,0785	0,00444
2200 406 02XX	RİTA MEK TUŞ JALUZİ ANAHTARI (VİDALI) BLIND SWITCH (CONTROL SWITCH)	12	120	0,089	0,00037	1,068	0,00444
2200 407 02XX	RİTA MEK TUŞ ÇAĞIRMA (VİDALI) ONE GANG ONE WAY SWITCH (LIGHT) (PUSH Plate)	12	120	0,0835	0,00037	1,002	0,00444
2200 407 02XXK	RİTA MEK TUŞ KAPI OTOMATİĞİ ANAHTARI(VİDALI DOOR SWITCH)	12	120	0,0835	0,00037	1,002	0,00444
2200 407 02XXZ	RİTA MEK TUŞ ZİL ANAHTARI(VİDALI) BELL SWITCH	12	120	0,0835	0,00037	1,002	0,00444
2200 408 02XX	RİTA MEK TUŞ DEVIATÖR(ARA VAVİEN)(VİDALI) ONE GANG INTERMEDIATE SWITCH	12	120	0,090166667	0,00037	1,082000004	0,00444
2200 409 02XX	RİTA MEK TUŞ ÜÇLÜ ANAHTAR (VİDALI) THREE GANG ONE WAY SWITCH	12	120	0,092	0,00037	1,104	0,00444
2200 411 02XX	RİTA MEK TUŞ ŞOFBEN ANAHTARI (VİDALI) HEATER SWITCH	12	120	0,077083333	0,00037	0,924999996	0,00444
2200 415 02XX	RİTA MEK TUŞ IŞIKLI ANAHTAR (220V)(VİDALI) ILLUMINATED ONE (220V)GANG ONE WAY SWITCH	12	120	0,085833333	0,00037	1,029999996	0,00444
2200 416 02XX	RİTA MEK TUŞ IŞIKLI VAVİEN (220V)(VİDALI) ILLUMINATED ONE GANG TWO WAY	12	120	0,088583333	0,00037	1,062999996	0,00444
2200 417 02XX	RİTA MEK TUŞ IŞIKLI ÇAĞIRMA(220V)(VİDALI) ILLUMINATED ONE GANG ONE WAY (PUSH Plate) SWITCH)	12	120	0,086583333	0,00037	1,038999996	0,00444
2200 418 02XX	RİTA MEK TUŞ IŞIKLI ETİK. ANAHTAR (220V)(VİDALI) ILLUMINATED 1 G 1 W SWITCH WITH LABEL	12	120	0,085833333	0,00037	1,029999996	0,00444
2200 419 02XX	RİTA MEK TUŞ IŞIKLI ETİK. ÇAĞIRMA (220V)(VİDALI) ILLUMINATED 1 G 1 W SWITCH WITH LABEL (PUSH Plate)	12	120	0,085708333	0,00037	1,028499996	0,00444
2200 422 02XX	RİTA MEK TUŞ IŞIKLI ZİL ETİK. ÇAĞIRMA(12V)(VİDALI) ILLUMINATED ONE GANG ONE WAY SWITCH (PUSH Plate)	12	120	0,087791667	0,00037	1,053500004	0,00444
2200 425 02XX	RİTA MEK TUŞ TEK TUŞLU JALUZİ ANAHTARI (VİDALI) SINGLE BLIND SWITCH	12	120	0,089	0,00037	1,068	0,00444
2200 426 02XX	RİTA MEK TUŞ IŞIKLI KOMÜTATÖR(VİDALI) ILLUMINATED TWO GANG ONE WAY SWITCH (220V)	12	120	0,089333333	0,00037	1,071999996	0,00444
2200 436 02XX	RİTA MEK TUŞ JALUZİ ANAHTARI (VİDALI) (YAYSIZ) BLIND SWITCH	12	120	0,089	0,00037	1,068	0,00444

MEKANİZMA + TUŞ ÜRÜN LİSTESİ • MECHANISM + SWITCH PRODUCT LIST

ANAHTAR GRUBU KLİPSLİ SWITCH GROUP EASY CONNECTION

KOD CODE	ÜRÜN TANIMI DESCRIPTION	KUTU BOX	KOLİ PARCEL	BİRİM AĞIRLIK UNIT WEIGHT	BİRİM HACİM UNIT VOLUME	KUTU AĞIRLIK BOX WEIGHT	KUTU HACİM BOX VOLUME
2200 401 01XX	RİTA MEK TUŞ ANAHTAR (KLİPSLİ) ONE GANG ONE WAY SWITCH	12	120	0,083	0,00037	0,996	0,00444
2200 402 01XX	RİTA MEK TUŞ KOMÜTATÖR (KLİPSLİ) TWO GANG ONE WAY SWITCH	12	120	0,084	0,00037	1,008	0,00444
2200 403 01XX	RİTA MEK TUŞ VAVİEN(İKİ YOLLU ANAHTAR)(KLİPSLİ) ONE GANG TWO WAY SWITCH (VA-ET-VIENT)	12	120	0,083	0,00037	0,996	0,00444
2200 404 01XX	RİTA MEK TUŞ KOMÜTATÖR VAVİEN(KLİPSLİ) TWO GANG TWO WAY SWITCH (COMMUTATOR VEAVIEN)	12	120	0,086458333	0,00037	1,037499996	0,00444
2200 405 01XX	RİTA MEK TUŞ ÇİFT KUTUPLU ANAHTAR(KLİPSLİ) DOUBLE POLE SWITCH	12	120	0,086208333	0,00037	1,034499996	0,00444
2200 406 01XX	RİTA MEK TUŞ JALUZİ ANAHTARI-YAYLI (KLİPSLİ) BLIND SWITCH (CONTROL SWITCH)	12	120	0,086	0,00037	1,032	0,00444
2200 407 01XX	RİTA MEK TUŞ ÇAĞIRMA (KLİPSLİ) ONE GANG ONE WAY SWITCH (LIGHT) (PUSH Plate)	12	120	0,082833333	0,00037	0,993999996	0,00444
2200 407 0101K	RİTA MEK TUŞ KAPI OTOMATIĞI ANAHTARI(KLİPSLİ) DOOR SWITCH	12	120	0,082833333	0,00037	0,993999996	0,00444
2200 407 0101Z	RİTA MEK TUŞ ZİL ANAHTARI(KLİPSLİ) BELL SWITCH	12	120	0,082833333	0,00037	0,993999996	0,00444
2200 408 01XX	RİTA MEK TUŞ DEVIATÖR(ARA VAVİEN)(KLİPSLİ) ONE GANG INTERMEDIATE SWITCH	12	120	0,087416667	0,00037	1,049000004	0,00444
2200 409 01XX	RİTA MEK TUŞ ÜÇLÜ ANAHTAR (KLİPSLİ) THREE GANG ONE WAY SWITCH	12	120	0,088	0,00037	1,056	0,00444
2200 415 01XX	RİTA MEK TUŞ IŞIKLI ANAHTAR (220V)(KLİPSLİ) ILLUMINATED ONE (220V)GANG ONE WAY SWITCH	12	120	0,084333333	0,00037	1,011999996	0,00444
2200 416 01XX	RİTA MEK TUŞ IŞIKLI VAVİEN (220V)(KLİPSLİ) ILLUMINATED ONE GANG TWO WAY	12	120	0,085166667	0,00037	1,022000004	0,00444
2200 417 01XX	RİTA MEK TUŞ IŞIKLI ÇAĞIRMA(220V)(KLİPSLİ) ILLUMINATED ONE GANG ONE WAY (PUSH Plate) SWITCH	12	120	0,084791667	0,00037	1,017500004	0,00444
2200 418 01XX	RİTA MEK TUŞ IŞIKLI ETİK. ANAHTAR (220V)(KLİPSLİ) ILLUMINATED 1 G 1 W SWITCH WITH LABEL	12	120	0,085458333	0,00037	1,025499996	0,00444
2200 419 01XX	RİTA MEK TUŞ IŞIKLI ETİK. ÇAĞIRMA (220V)(KLİPSLİ) ILLUMINATED 1 G 1 W SWITCH WITH LABEL (PUSH Plate)	12	120	0,085875	0,00037	1,0305	0,00444
2200 422 01XX	RİTA MEK TUŞ IŞIKLI ZİL ETİK. ÇAĞIRMA(12V)(KLİPSLİ) ILLUMINATED ONE GANG ONE WAY SWITCH (PUSH Plate)	12	120	0,085458333	0,00037	1,025499996	0,00444
2200 426 01XX	RİTA MEK TUŞ IŞIKLI KOMÜTATÖR(KLİPSLİ) ILLUMINATED TWO GANG ONE WAY SWITCH (220V)	12	120	0,08625	0,00037	1,035	0,00444
2200 436 01XX	RİTA MEK TUŞ JALUZİ ANAHTARI (KLİPSLİ) (YAYSIZ) BLIND SWITCH	12	120	0,086	0,00037	1,032	0,00444

DİMMER GRUBU DIMMER GROUP

KOD CODE	ÜRÜN TANIMI DESCRIPTION	KUTU BOX	KOLİ PARCEL	BİRİM AĞIRLIK UNIT WEIGHT	BİRİM HACİM UNIT VOLUME	KUTU AĞIRLIK BOX WEIGHT	KUTU HACİM BOX VOLUME
2200 440 02XX	RİTA MEK TUŞ RL IŞIKLI DİMMER 600W RL ROTARY DIMMER (600W)	8	80	0,1	0,00055	0,8	0,0044
2200 444 02XX	RİTA MEK TUŞ RL IŞIKLI DİMMER 1000W RROTARY DIMMER (1000W)	8	80	0,10725	0,00055	0,858	0,0044
2200 447 02XX	RİTA MEK TUŞ RC DİMMER 325W RC DIMMER (325W)	8	80	0,1	0,00055	0,8	0,0044

ELEKTRONİK GRUBU ELECTRONIC GROUP

KOD CODE	ÜRÜN TANIMI DESCRIPTION	KUTU BOX	KOLİ PARCEL	BİRİM AĞIRLIK UNIT WEIGHT	BİRİM HACİM UNIT VOLUME	KUTU AĞIRLIK BOX WEIGHT	KUTU HACİM BOX VOLUME
2200 450 01XX	RİTA MEK TUŞ ENERGY SAVER G.SİZ IŞIKLI ENERGY SAVER ILLUMINATED	8	80	0,1003125	0,00055	0,8025	0,0044
2200 452 01XX	RİTA MEK TUŞ ENERGY SAVER GECİKMELİ IŞIKLI ENERGY SAVER WITH DELAY	8	80	0,1060625	0,00055	0,8485	0,0044
2200 470 02XX	RİTA MEK TUŞ MÜZİK YAYIN ANAHTARI AUDIO SWITCH	8	80	0,0945625	0,00055	0,7565	0,0044
2200 480 01XX	RİTA MEK TUŞ HOPARLÖR PRİZİ SPEAKER SOCKET	12	120	0,068666667	0,00037	0,824000004	0,00444
2200 485 02XX	RİTA MEK TUŞ UYARI ZİLİ WARNING SWITCH	8	80	0,0948125	0,00055	0,7585	0,0044
2200 495 02XX	RİTA MEK TUŞ HAREKET SENSÖRÜ MOVEMENT SENSOR	8	80	0,1150625	0,00055	0,9205	0,0044

MEKANİZMA + TUŞ ÜRÜN LİSTESİ • MECHANISM + SWITCH PRODUCT LIST

PRİZ GRUBU SOCKET GROUP

KOD CODE	ÜRÜN TANIMI DESCRIPTION	KUTU BOX	KOLİ PARCEL	BİRİM AĞIRLIK UNIT WEIGHT	BİRİM HACİM UNIT VOLUME	KUTU AĞIRLIK BOX WEIGHT	KUTU HACİM BOX VOLUME
2200 600 02XX	RİTA MEK TUŞ TOP.LI PRİZ EARTHED SOCKET OUTLET	12	120	0,081	0,00037	0,972	0,00444
2200 601 02XX	RİTA MEK TUŞ TOPRAKSIZ PRİZ SOCKET OUTLET NON- EARTHED	12	120	0,072	0,00037	0,864	0,00444
2200 605 02XX	RİTA MEK TUŞ TOP.LI PRİZ(Ç.K.) EARTHED SOCKET OUTLET WITH CHILD PROTECTION	12	120	0,082	0,00037	0,984	0,00444
2200 606 02XX	RİTA MEK TUŞ TOP.SIZ PRİZ(Ç.K.) SOCKET OUTLET WITH CHILD PROTECTION NON EARTHED	12	120	0,073	0,00037	0,876	0,00444
2200 610 02XX	RİTA MEK TUŞ KAPAKLI TOP.LI PRİZ EARTHED SOCKET WITH COVER	12	120	0,086	0,00037	1,032	0,00444
2200 611 02XX	RİTA MEK TUŞ KAPAKLI TOP.LI PRİZ (Ç.K.) EARTHED SOCKET WITH CHIL PROTECTION COVER	12	120	0,087	0,00037	1,044	0,00444
2200 615 02XX	RİTA MEK TUŞ UPS (FRANSIZ) PRİZİ UPS (FRENCH) SOCKET (EARTHED SOCKET WITH PIN)	12	120	0,082	0,00037	0,984	0,00444
2200 616 02XX	RİTA MEK TUŞ UPS (FRANSIZ) PRİZİ(Ç.K.) UPS (FRENCH) SOCKET OUTLET WITH CHULD PROTECTION	12	120	0,082	0,00037	0,984	0,00444
2200 617 02XX	RİTA MEK TUŞ UPS KAPAKLI (FRANSIZ) PRİZ UPS SOCKET (FRENCH) WITH COVER	12	120	0,085	0,00037	1,02	0,00444
2200 618 02XX	RİTA MEK TUŞ UPS KAPAKLI (FRANSIZ) PRİZ (Ç.K.) UPS SOCKET (FRENCH) WITH SAFETY CHILD PROTECTION	12	120	0,088	0,00037	1,056	0,00444
2200 200 02XX	RİTA MEK TUŞ İKİLİ TOPRAKLI PRİZ PORSELEN DOUBLE SOCKET EARTHED PORCELAIN	5	50	0,1453	0,00088	0,7265	0,0044
2200 201 02XX	RİTA MEK TUŞ İKİLİ TOPRAKSIZ PRİZ PORSELEN DOUBLE SOCKET NON EARTHED PORCELAIN	5	50	0,115	0,00088	0,575	0,0044
2200 202 02XX	RİTA MEK TUŞ İKİLİ TOPRAKLI PRİZ DOUBLE SOCKET EARTHED	5	50	0,0978	0,00088	0,489	0,0044
2200 203 02XX	RİTA MEK TUŞ İKİLİ TOPRAKSIZ PRİZ DOUBLE SOCKET (NON EARTHED)	5	50	0,0971	0,00088	0,4855	0,0044
2200 215 02XX	RİTA MEK TUŞ İKİLİ UPS PRİZ DOUBLE SOCKET WITH UPS	8	80	0,1	0,00055	0,8	0,0044
2200 448 01XX	RİTA MEK TUŞ TEKLİ USB ŞARJ PRİZİ USB CHARGE SOCKET	8	80	0,1	0,00055	0,8	0,0044
2200 449 01XX	RİTA MEK TUŞ İKİLİ USB ŞARJ PRİZİ USB CHARGE TWO SOCKET	8	-	0,156	0,0005252	1,248	0,0042016
2220 619 02XX	RİTA İKİLİ USB Lİ TOPRAKLI PRİZ (Çerçeve Dahil) EARTHED SOCKET DOUBLE USB (WITH FRAME)	8	-	0,156	0,0005252	1,248	0,0042016
2220 629 02XX	RİTA USB +TYPE-C Lİ TOPRAKLI PRİZ (Çerçeve Dahil) 2*USB +TYPE-C CHARGER	8	-	0,156	0,0005252	1,248	0,0042016

TV / SAT GRUBU GRUBU TV/SAT GROUP

KOD CODE	ÜRÜN TANIMI DESCRIPTION	KUTU BOX	KOLİ PARCEL	BİRİM AĞIRLIK UNIT WEIGHT	BİRİM HACİM UNIT VOLUME	KUTU AĞIRLIK BOX WEIGHT	KUTU HACİM BOX VOLUME
2200 156 02XX	MEK+TUŞ TV-SAT PRİZİ (GEÇİŞLİ) 4DB/F KONNEKTÖR TV / SAT SOCKET (THROUGH) 4DB/F CON.	12	120	0,089	0,00037	1,068	0,00444
2200 157 02XX	MEK+TUŞ TV-SAT PRİZİ (SONLU) TV / SAT SOCKET (DEAD-END)	12	120	0,089	0,00037	1,068	0,00444
2200 166 01XX	MEK+TUŞ SAT PRİZİ (GEÇİŞLİ) 4DB/F KONNEKTÖR SAT SOCKET (THROUGH)	12	120	0,086	0,00037	1,032	0,00444
2200 167 01XX	MEK+TUŞ SAT PRİZİ (SONLU) SAT SOCKET (DEAD-END)	12	120	0,086291667	0,00037	1,035500004	0,00444
2200 170 01XX	MEK+TUŞ TV PRİZİ (GEÇİŞLİ) 11DB TV SOCKET (THROUGH) 11 DB	12	120	0,083583333	0,00037	1,002999996	0,00444
2200 171 01XX	MEK+TUŞ TV PRİZİ (SONLU) TV SOCKET (DEAD-END)	12	120	0,083583333	0,00037	1,002999996	0,00444
2200 172 01XX	MEK+TUŞ TV PRİZİ F DIŞI TV SOCKET F FEMALE	12	120	0,07	0,00037	0,84	0,00444

MEKANİZMA + TUŞ ÜRÜN LİSTESİ • MECHANISM + SWITCH PRODUCT LIST

İLETİŞİM GRUBU COMMUNICATION GROUP

KOD CODE	ÜRÜN TANIMI DESCRIPTION	KUTU BOX	KOLİ PARCEL	BİRİM AĞIRLIK UNIT WEIGHT	BİRİM HACİM UNIT VOLUME	KUTU AĞIRLIK BOX WEIGHT	KUTU HACİM BOX VOLUME
2200 125 01XX	MEK+TUŞ TELEFON PRİZİ 1*RJ12 (CAT 3) TELEPHONE SOCKET 1*RJ12 (CAT 3)	12	120	0,066833333	0,00037	0,801999996	0,00444
2200 126 01XX	MEK+TUŞ TELEFON PRİZİ 2*RJ12 TELEPHONE SOCKET 2*RJ12 (CAT 3)	12	120	0,075875	0,00037	0,9105	0,00444
2200 128 01XX	MEK+TUŞ ETİKETLİ TELEFON DATA PRİZ (KONNEKTÖRSÜZ) TELEPHONE DATA SOCKET WITH LABEL(WITHOUT CONNECTOR)	12	120	0,059291667	0,00037	0,711500004	0,00444
2200 135 01XX	MEK+TUŞ DATA PRİZİ 1*RJ45 (KONNEKTÖRSÜZ) DATA SOCKET 1*RJ45 (WITHOUT CONNECTOR)	12	120	0,06	0,00037	0,72	0,00444
2200 136 01XX	MEK+TUŞ DATA PRİZİ 1*RJ45 (CAT5E) DATA SOCKET 1*RJ45 (CAT 5E)	12	120	0,069666667	0,00037	0,836000004	0,00444
2200 137 01XX	MEK+TUŞ DATA PRİZİ 2*RJ45 (KONNEKTÖRSÜZ) DATA SOCKET 2*RJ45 (WITHOUT CONNECTOR)	12	120	0,059166667	0,00037	0,710000004	0,00444
2200 138 01XX	MEK+TUŞ DATA PRİZİ 2*RJ45 (CAT5E) DATA SOCKET 2*RJ45 (CAT5E)	12	120	0,074	0,00037	0,888	0,00444
2200 139 01XX	MEK+TUŞ TELEFON DATA PRİZ (RJ12 CAT + CAT5e) DATA SOCKET RJ12 CAT + CAT5e	12	120	0,078	0,00037	0,936	0,00444
2200 140 01XX	MEK+TUŞ DATA PRİZİ 1*RJ45 (CAT6) DATA SOCKET 1*RJ45 (CAT6)	12	120	0,068	0,00037	0,816	0,00444
2200 141 01XX	MEK+TUŞ DATA PRİZİ 2*RJ45 (CAT6) DATA SOCKET 2*RJ45 (CAT6)	12	120	0,077083333	0,00037	0,924999996	0,00444
2200 455 01XX	MEK+TUŞ DATA PRİZİ 1*USB DATA SOCKET 1*USB	12	120	0,066166667	0,00037	0,794000004	0,00444
2200 456 01XX	MEK+TUŞ DATA PRİZİ 2*USB DATA SOCKET 2*USB	12	120	0,07125	0,00037	0,855	0,00444
2200 457 01XX	MEK+TUŞ DATA PRİZİ 1*HDMI DATA SOCKET 1*HDMI	12	120	0,068083333	0,00037	0,816999996	0,00444
2200 458 01XX	MEK+TUŞ DATA PRİZİ 2*HDMI DATA SOCKET 2*HDMI	12	120	0,073791667	0,00037	0,885000004	0,00444
2200 459 01XX	MEK+TUŞ DATA PRİZİ 1*USB / 1*HDMI DATA SOCKET 1*USB / 1*HDMI	12	120	0,072041667	0,00037	0,864500004	0,00444
2200 460 01XX	MEK+TUŞ VGA PRİZİ VGA SOCKET	12	120	0,071333333	0,00037	0,855999996	0,00444
2200 147 01XX	MEK+TUŞ BİR ÇIKIŞLI FİBER OPTİK PRİZ (RJ45) MEK+TUŞ ONE OUTPUT FIBER OPTIC SOCKET (RJ45)	12	120	0,077	0,00037	0,924	0,00444
2200 461 01XX	MEK+TUŞ İKİ ÇIKIŞLI FİBER OPTİK PRİZ TWO-OUTPUT FIBER OPTIC SOCKET	12	120	0,071	0,00037	0,852	0,00444
2200 121 01XX	MEK+TUŞ KÖR KAPAK BLIND COVER	12	120	0,056958333	0,00037	0,683499996	0,00444

ÇERÇEVELER FRAMES

KOD CODE	ÜRÜN TANIMI DESCRIPTION	KUTU BOX	KOLİ PARCEL	BİRİM AĞIRLIK UNIT WEIGHT	BİRİM HACİM UNIT VOLUME	KUTU AĞIRLIK BOX WEIGHT	KUTU HACİM BOX VOLUME
2220 800 11XX	TEKLİ ÇERÇEVE SINGLE FRAME	20	400	0,025	0,00012	0,5	0,0024
2220 800 12XX	İKİLİ YATAY ÇERÇEVE DOUBLE HORIZONTAL FRAME	10	200	0,042	0,00021	0,42	0,0021
2220 800 13XX	ÜÇLÜ YATAY ÇERÇEVE TRIPLE HORIZONTAL FRAME	10	50	0,0593	0,00027	0,593	0,0027
2220 800 14XX	DÖRTLÜ YATAY ÇERÇEVE QUADRUPLE HORIZONTAL FRAME	10	50	0,0733	0,00034	0,733	0,0034
2220 800 15XX	BEŞLİ YATAY ÇERÇEVE FIVE HORIZONTAL FRAME	10	50	0,0895	0,0004	0,895	0,004
2220 800 16XX	ALTILI YATAY ÇERÇEVE SIX HORIZONTAL FRAME	10	50	0,112	0,00048	1,12	0,0048
2220 800 22XX	İKİLİ DİKEY ÇERÇEVE DOUBLE VERTICAL FRAME	10	200	0,042	0,00024	0,42	0,0024
2220 800 23XX	ÜÇLÜ DİKEY ÇERÇEVE TRIPLE VERTICAL FRAME	10	50	0,0593	0,00027	0,593	0,0027
2220 800 24XX	DÖRTLÜ DİKEY ÇERÇEVE QUADRUPLE VERTICAL FRAME	10	50	0,0733	0,00034	0,733	0,0034
2220 800 25XX	BEŞLİ DİKEY ÇERÇEVE FIVE VERTICAL FRAME	10	50	0,0895	0,0004	0,895	0,004
2220 800 26XX	ALTILI DİKEY ÇERÇEVE SIX-UP VERTICAL FRAME	10	50	0,11	0,00048	1,1	0,0048
2200 000 11XX	SIVA ÜSTÜ ANAHTAR KASASI (GEÇMELİ) SURFACE MOUNTED KEY SAFE (PLUG-IN)	10	50	0,059	0,00049	0,59	0,0049
2200 800 00XX	TELEFON TUTUCU PHONE HOLDER	24	240	0,0109	0,00019	0,2616	0,00456
2200 000 0001	IP44 KAPAKLI PRİZ CONTA IP44 COVERED SOCKET GASKET	12	120	0,1	0,00034666	1,2	0,00415992

PASTEL ÇERÇEVELER PASTEL FRAMES

2220 800 11XX	TEKLİ ÇERÇEVE SINGLE FRAME	20	400	0,025	0,00012	0,5	0,0024
2220 800 12XX	İKİLİ YATAY ÇERÇEVE DOUBLE HORIZONTAL FRAME	10	200	0,042	0,00021	0,42	0,0021
2220 800 13XX	ÜÇLÜ YATAY ÇERÇEVE TRIPLE HORIZONTAL FRAME	10	50	0,0593	0,00027	0,593	0,0027
2220 800 14XX	DÖRTLÜ YATAY ÇERÇEVE QUADRUPLE HORIZONTAL FRAME	10	50	0,0733	0,00034	0,733	0,0034
2220 800 15XX	BEŞLİ YATAY ÇERÇEVE FIVE HORIZONTAL FRAME	10	50	0,0895	0,0004	0,895	0,004
2220 800 16XX	ALTILI YATAY ÇERÇEVE SIX HORIZONTAL FRAME	10	50	0,112	0,00048	1,12	0,0048
2220 800 22XX	İKİLİ DİKEY ÇERÇEVE BEYAZ DOUBLE VERTICAL FRAME WHITE	10	200	0,042	0,00024	0,42	0,0024
2220 800 23XX	ÜÇLÜ DİKEY ÇERÇEVE BEYAZ TRIPLE VERTICAL FRAME WHITE	10	50	0,0593	0,00027	0,593	0,0027
2220 800 24XX	DÖRTLÜ DİKEY ÇERÇEVE BEYAZ QUADRUPLE VERTICAL FRAME WHITE	10	50	0,0733	0,00034	0,733	0,0034
2220 800 25XX	BEŞLİ DİKEY ÇERÇEVE BEYAZ FIVE VERTICAL FRAME WHITE	10	50	0,0895	0,0004	0,895	0,004
2220 800 26XX	ALTILI DİKEY ÇERÇEVE BEYAZ SIX-UP VERTICAL FRAME WHITE	10	50	0,11	0,00048	1,1	0,0048

Ritā

Konforlu Yaşamın Anahtarı!
The Key to Comfortable Living!



Rita anahtar ve priz serisi, estetik ve fonksiyonelliği bir araya getirerek yaşam alanlarınızda fark yaratır. Modern ve şık tasarımıyla her dekorasyon stiline mükemmel uyum sağlayan Rita, dayanıklı yapısıyla uzun ömürlü kullanım sunar. Güvenliği ön planda tutan yapısıyla, evinizde ve iş yerinizde ihtiyaç duyduğunuz enerjiyi güvenle kullanmanıza olanak tanır. Rita ile tarzınızı yansıtın, konforu ve güvenliği bir arada yaşayın.

The Rita switch and socket series combines aesthetics and functionality to make a difference in your living spaces. With its modern and sleek design, Rita seamlessly blends with any decor style, offering long-lasting durability. Prioritizing safety, Rita ensures you can use the energy you need at home or in the workplace with confidence. Reflect your style with Rita, and experience comfort and safety in one.



Ritä

Natural



Elitra



**"İnceliğin
ve Şıklığın
Buluşma Noktası"**

"Your subtlety and elegance Meeting point"

Elitra

"Her Tarza İnce Bir Dokunuş"
"A Subtle Touch to Every Style"



İnce yapısı sayesinde duvarda zarif bir görünüm sunarken, cam çerçevesi mekana sofistike bir dokunuş katıyor.

Thanks to its slim design, it offers an elegant appearance on the wall, while the glass frame adds a sophisticated touch to the space.



Glass **Elitra**

Elitra

Chrome

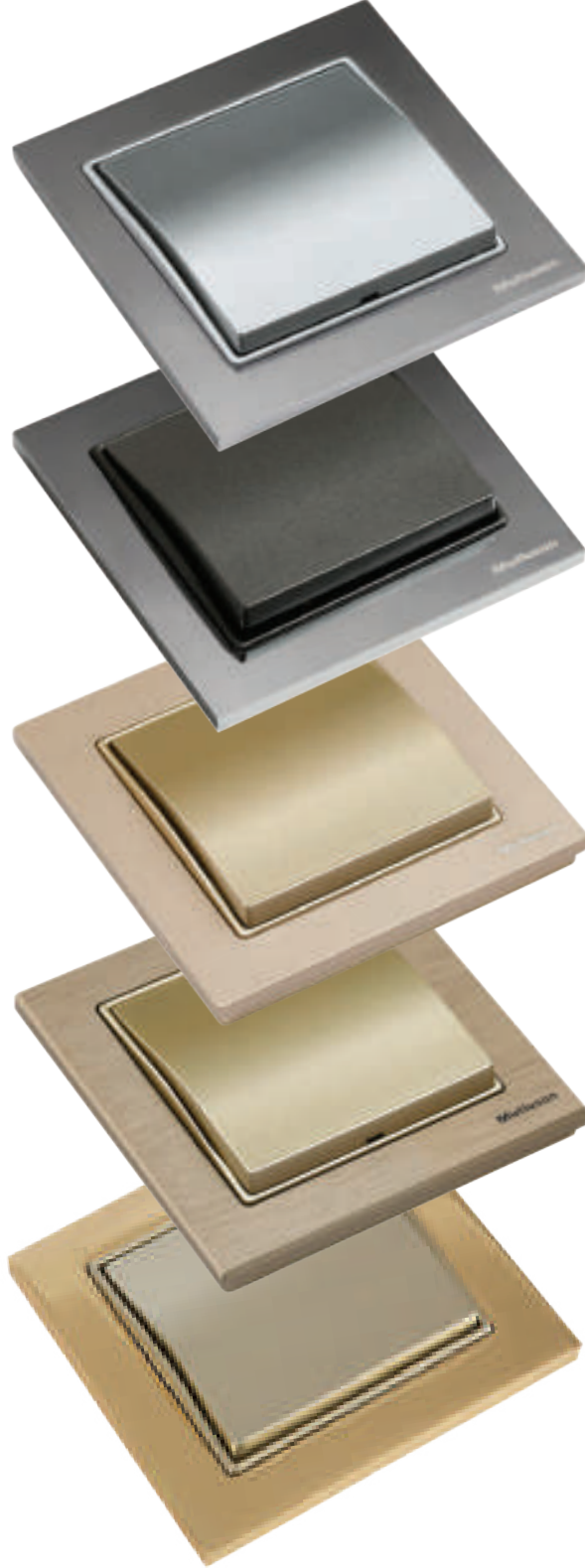

"İnceliđi Evinize Taşıyın"
"Bring Fineness to Your Home"

RENK SEÇENEKLERİ COLOR OPTIONS

Elitra Chrome



Çerçeve (XX) :21 Krom
Tuş (YY) :95 Füme
Frame (XX) :21 Chrome
Plate (YY) :95 Smoked

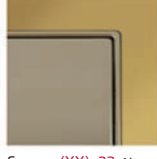

Çerçeve (XX) :22 Altın
Tuş (YY) :90 Saten
Frame (XX) :22 Gold
Plate (YY) :90 Satin

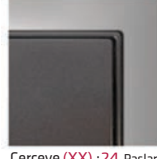

Çerçeve (XX) :24 Paslanmaz Çelik
Tuş (YY) :95 Füme
Frame (XX) :24 Stainless Steel
Plate (YY) :95 Smoked

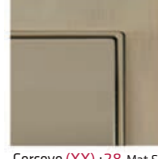

Çerçeve (XX) :28 Mat Saten
Tuş (YY) :90 Saten
Frame (XX) :28 Mat Satin
Plate (YY) :90 Satin

Elitra Marble



Çerçeve (XX) :42 Siyah Quartz
Tuş (YY) :92 Gümüş
Frame (XX) :42 Black Quartz
Plate (YY) :92 Silver

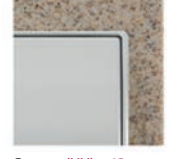

Çerçeve (XX) :43 Stand Stone
Tuş (YY) :92 Gümüş
Frame (XX) :43 Stand Stone
Plate (YY) :92 Silver



Çerçeve (XX) :25 Parlak Füme
Tuş (YY) :92 Gümüş
Frame (XX) :25 Bright Smoked
Plate (YY) :92 Silver



Çerçeve (XX) :25 Parlak Füme
Tuş (YY) :95 Füme
Frame (XX) :25 Bright Smoked
Plate (YY) :95 Smoked



Çerçeve (XX) :27 Mat Alüminyum
Tuş (YY) :95 Füme
Frame (XX) :27 Mat Aluminium
Plate (YY) :95 Smoked

Elitra Glass



Çerçeve (XX) :11 Beyaz
Tuş (YY) :01 Beyaz
Frame (XX) :11 White
Plate (YY) :01 White



Çerçeve (XX) :14 Siyah
Tuş (YY) :92 Gümüş
Frame (XX) :14 Black
Plate (YY) :92 Silver

Elitra Wood



Çerçeve (XX) :32 Kayın
Tuş (YY) :92 Gümüş
Frame (XX) :32 Beech
Plate (YY) :92 Silver



Çerçeve (XX) :33 Kiraz
Tuş (YY) :90 Saten
Frame (XX) :33 Cherry
Plate (YY) :90 Satin



Çerçeve (XX) :34 Venge
Tuş (YY) :92 Gümüş
Frame (XX) :34 Venge
Plate (YY) :92 Silver

Elitra Ale



Çerçeve (XX) :51 Natural
Tuş (YY) :95 Füme
Frame (XX) :51 Natural
Plate (YY) :95 Smoked



Çerçeve (XX) :52 Saten
Tuş (YY) :90 Saten
Frame (XX) :52 Satin
Plate (YY) :90 Satin



Çerçeve (XX) :53 Mat Füme
Tuş (YY) :92 Gümüş
Frame (XX) :53 Mat Smoked
Plate (YY) :92 Silver

YATAY ÇERÇEVELER HORIZONTAL FRAMES



2170 8XX 11YY
1'li Çerçeve 1 Gang frame



2170 8XX 12YY
2'li Çerçeve 2 Gang frame

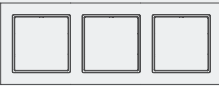

2170 8XX 13YY
3'li Çerçeve 3 Gang frame



2170 8XX 14YY
4'lü Çerçeve 4 Gang frame

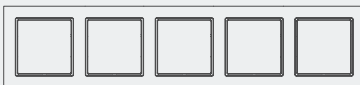

2170 8XX 15YY
5'li Çerçeve 5 Gang frame



2170 8XX 16YY
6'li Çerçeve 6 Gang frame

DIKEY ÇERÇEVELER VERTICAL FRAMES

2170 8XX 22YY
2'li Çerçeve
2 Gang frame



2170 8XX 23YY
3'li Çerçeve
3 Gang frame



2170 8XX 24XX
4'lü Çerçeve
4 Gang frame



2170 8XX 25XX
5'li Çerçeve
5 Gang frame



2170 8XX 26XX
6'li Çerçeve
6 Gang frame



Bu ürün kodlarında **XX** çerçeve rengini belirtmektedir.
YY specify frame color for these products.

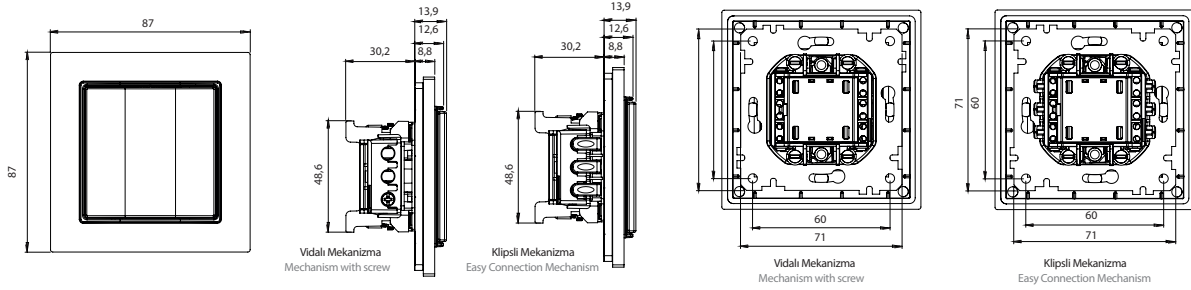

MEKANİZMA + TUŞ ÜRÜN LİSTESİ • MECHANISM + SWITCH PRODUCT LIST

ANAHTAR GRUBU VİDALI SWITCH GROUP (WITH SCREW)

KOD CODE	ÜRÜN TANIMI DESCRIPTION	KUTU BOX	KOLİ PARCEL	BİRİM AĞIRLIK UNIT WEIGHT	BİRİM HACİM UNIT VOLUME	KUTU AĞIRLIK BOX WEIGHT	KUTU HACİM BOX VOLUME
2270 401 02XX	MEK+TUŞ ANAHTAR ONE GANG ONE WAY SWITCH	12	120	0,101	0,00043	1,212	0,00516
2270 402 02XX	MEK+TUŞ KOMÜTATÖR TWO GANG ONE WAY SWITCH	12	120	0,103	0,00043	1,236	0,00516
2270 403 02XX	MEK+TUŞ VAVİEN(İKİ YOLLU ANAHTAR) VAVIEN (TWO WAY SWITCH)	12	120	0,102	0,00043	1,224	0,00516
2270 404 02XX	MEK+TUŞ KOMÜTATÖR VAVİEN COMMUTATOR VAVIEN	12	120	0,108	0,00043	1,296	0,00516
2270 405 02XX	MEK+TUŞ ÇİFT KUTUPLU ANAHTAR DOUBLE POLE SWITCH	12	120	0,105	0,00043	1,26	0,00516
2270 406 02XX	MEK+TUŞ JALUZİ ANAHTARI-YAYLI BLIND SWITCH (CONTROL SWITCH)	12	120	0,105	0,00043	1,26	0,00516
2270 407 02XX	MEK+TUŞ ÇAĞIRMA (LİGHT) ONE GANG ONE WAY SWITCH (LIGHT)(PUSH Plate)	12	120	0,102	0,00043	1,224	0,00516
2270 407 02XXK	MEK+TUŞ KAPI OTOMATIĞI ANAHTARI DOOR SWITCH	12	120	0,102	0,00043	1,224	0,00516
2270 407 02XXZ	MEK+TUŞ ZİL ANAHTARI BELL SWITCH	12	120	0,102	0,00043	1,224	0,00516
2270 408 02XX	MEK+TUŞ DEVIATÖR (ARA VAVİEN) ONE GANG INTERMEDIATE SWITCH	12	120	0,105	0,00043	1,26	0,00516
2270 409 02XX	MEK+TUŞ ÜÇLÜ ANAHTAR THREE GANG ONE WAY SWITCH	12	120	0,107	0,00043	1,284	0,00516
2270 411 02XX	MEK+TUŞ ELİTRA ŞOFBEN ANAHTARI HEATER SWITCH	12	120	0,091	0,00043	1,092	0,00516
2270 415 02XX	MEK+TUŞ IŞIKLI ANAHTAR (220V) ILLUMINATED ONE (220V)GANG ONE WAY SWITCH	12	120	0,102	0,00043	1,224	0,00516
2270 416 02XX	MEK+TUŞ IŞIKLI VAVİEN (220V) ILLUMINATED ONE GANG TWO WAY	12	120	0,105	0,00043	1,26	0,00516
2270 417 02XX	MEK+TUŞ IŞIKLI ÇAĞIRMA(220V) ILLUMINATED ONE GANG ONE WAY (PUSH Plate) SWITCH	12	120	0,102	0,00043	1,224	0,00516
2270 418 02XX	MEK+TUŞ IŞIKLI ETİKETLİ ANAHTAR (220V) ILLUMINATED 1 G 1W SWITCH WITH LABEL	12	120	0,102	0,00043	1,224	0,00516
2270 419 02XX	MEK+TUŞ IŞIKLI ETİKETLİ ÇAĞIRMA (220V) ILLUMINATED 1 G 1W SWITCH WITH LABEL (PUSH Plate)	12	120	0,101	0,00043	1,212	0,00516
2270 422 02XX	MEK+TUŞ IŞIKLI ZİL ÇAĞIRMA (12V) ILLUMINATED ONE GANG ONE WAY SWITCH (PUSH Plate)	12	120	0,101	0,00043	1,212	0,00516
2270 426 02XX	MEK+TUŞ IŞIKLI KOMÜTATÖR ILLUMINATED TWO GANG ONE WAY SWITCH (220V)	12	120	0,101	0,00043	1,212	0,00516

ANAHTAR GRUBU KLİPSLİ SWITCH GROUP EASY CONNECTION

KOD CODE	ÜRÜN TANIMI DESCRIPTION	KUTU BOX	KOLİ PARCEL	BİRİM AĞIRLIK UNIT WEIGHT	BİRİM HACİM UNIT VOLUME	KUTU AĞIRLIK BOX WEIGHT	KUTU HACİM BOX VOLUME
2270 401 01XX	MEK+TUŞ ANAHTAR ONE GANG ONE WAY SWITCH	12	120	0,101	0,00043	1,212	0,00516
2270 402 01XX	MEK+TUŞ KOMÜTATÖR TWO GANG ONE WAY SWITCH	12	120	0,103	0,00043	1,236	0,00516
2270 403 01XX	MEK+TUŞ VAVİEN(İKİ YOLLU ANAHTAR) VAVIEN (TWO WAY SWITCH)	12	120	0,102	0,00043	1,224	0,00516
2270 404 01XX	MEK+TUŞ KOMÜTATÖR VAVİEN COMMUTATOR VAVIEN	12	120	0,108	0,00043	1,296	0,00516
2270 405 01XX	MEK+TUŞ ÇİFT KUTUPLU ANAHTAR DOUBLE POLE SWITCH	12	120	0,105	0,00043	1,26	0,00516
2270 406 01XX	MEK+TUŞ JALUZİ ANAHTARI-YAYLI BLIND SWITCH (CONTROL SWITCH)	12	120	0,105	0,00043	1,26	0,00516
2270 407 01XX	MEK+TUŞ ÇAĞIRMA (LİGHT) ONE GANG ONE WAY SWITCH (LIGHT)(PUSH Plate)	12	120	0,102	0,00043	1,224	0,00516
2270 407 01XXK	MEK+TUŞ KAPI OTOMATIĞI ANAHTARI DOOR SWITCH	12	120	0,102	0,00043	1,224	0,00516
2270 407 01XXZ	MEK+TUŞ ZİL ANAHTARI BELL SWITCH	12	120	0,102	0,00043	1,224	0,00516
2270 408 01XX	MEK+TUŞ DEVIATÖR (ARA VAVİEN) ONE GANG INTERMEDIATE SWITCH	12	120	0,105	0,00043	1,26	0,00516
2270 409 01XX	MEK+TUŞ ÜÇLÜ ANAHTAR THREE GANG ONE WAY SWITCH	12	120	0,107	0,00043	1,284	0,00516
2270 411 01XX	MEK+TUŞ ELİTRA ŞOFBEN ANAHTARI HEATER SWITCH	12	120	0,091	0,00043	0,91	0,0043
2270 415 01XX	MEK+TUŞ IŞIKLI ANAHTAR (220V) ILLUMINATED ONE (220V)GANG ONE WAY SWITCH	12	120	0,102	0,00043	1,224	0,00516
2270 416 01XX	MEK+TUŞ IŞIKLI VAVİEN (220V) ILLUMINATED ONE GANG TWO WAY	12	120	0,105	0,00043	1,26	0,00516
2270 417 01XX	MEK+TUŞ IŞIKLI ÇAĞIRMA(220V) ILLUMINATED ONE GANG ONE WAY (PUSH Plate) SWITCH	12	120	0,102	0,00043	1,224	0,00516
2270 418 01XX	MEK+TUŞ IŞIKLI ETİKETLİ ANAHTAR (220V) ILLUMINATED 1 G 1W SWITCH WITH LABEL	12	120	0,102	0,00043	1,224	0,00516
2270 419 01XX	MEK+TUŞ IŞIKLI ETİKETLİ ÇAĞIRMA (220V) ILLUMINATED 1 G 1W SWITCH WITH LABEL (PUSH Plate)	12	120	0,101	0,00043	1,212	0,00516
2270 422 01XX	MEK+TUŞ IŞIKLI ZİL ÇAĞIRMA (12V) ILLUMINATED ONE GANG ONE WAY SWITCH (PUSH Plate)	12	120	0,101	0,00043	1,212	0,00516
2270 426 01XX	MEK+TUŞ IŞIKLI KOMÜTATÖR ILLUMINATED TWO GANG ONE WAY SWITCH (220V)	12	120	0,101	0,00043	1,212	0,00516

DİMİMER GRUBU DIMMER GROUP

KOD CODE	ÜRÜN TANIMI DESCRIPTION	KUTU BOX	KOLİ PARCEL	BİRİM AĞIRLIK UNIT WEIGHT	BİRİM HACİM UNIT VOLUME	KUTU AĞIRLIK BOX WEIGHT	KUTU HACİM BOX VOLUME
2270 440 02XX	MEK+TUŞ IŞIKLI DİMİMER 600W RL ROTARY DIMMER (600 W)	8	80	0,109	0,00044	0,872	0,00352
2270 444 02XX	MEK+TUŞ IŞIKLI DİMİMER 1000W RL ROTARY DIMMER (1000 W)	8	80	0,117	0,00044	0,936	0,00352
2270 447 02XX	MEK+TUŞ RC DİMİMER 325W RC DIMMER (325 W)	8	80	0,111	0,00044	0,888	0,00352

MEKANİZMA + TUŞ ÜRÜN LİSTESİ • MECHANISM + SWITCH PRODUCT LIST

ELEKTRONİK GRUBU
ELECTRONIC GROUP

KOD CODE	ÜRÜN TANIMI DESCRIPTION	KUTU BOX	KOLİ PARCEL	BİRİM AĞIRLIK UNIT WEIGHT	BİRİM HACİM UNIT VOLUME	KUTU AĞIRLIK BOX WEIGHT	KUTU HACİM BOX VOLUME
2270 450 01XX	MEK+TUŞ ENERGY SAVER GEÇİKMESİZ IŞIKLI ENERGY SAVER ILLUMINATED	8	80	0,11	0,00054	0,88	0,00432
2270 452 01XX	MEK+TUŞ ENERGY SAVER GEÇİKMELİ ENERGY SAVER WITH DELAY	8	80	0,111	0,00054	0,888	0,00432
2270 470 02XX	MEK+TUŞ MÜZİK YAYIN ANAHTARI AUDIO SWITCH	8	80	0,102	0,00054	0,816	0,00432
2270 480 01XX	MEK+TUŞ HOPARLÖR PRİZİ SPEAKER SOCKET	12	120	0,08	0,00043	0,96	0,00516
2270 485 02XX	MEK+TUŞ UYARI ZİLİ WARNING SWITCH	8	80	0,101	0,00043	0,808	0,00344
2270 495 0290	MEK+TUŞ HAREKET SENSÖRÜ MOVEMENT SENSOR	8	80	0,115	0,00055	0,92	0,0044

PRİZ GRUBU
SOCKET GROUP

KOD CODE	ÜRÜN TANIMI DESCRIPTION	KUTU BOX	KOLİ PARCEL	BİRİM AĞIRLIK UNIT WEIGHT	BİRİM HACİM UNIT VOLUME	KUTU AĞIRLIK BOX WEIGHT	KUTU HACİM BOX VOLUME
2270 600 02XX	MEK+TUŞ TOPRAKLI PRİZ SOCKET OUTLET NON- EARTHED	12	120	0,093	0,00043	1,116	0,00516
2270 601 02XX	MEK+TUŞ TOPRAKSIZ PRİZ EARTHED SOCKET OUTLET WITH CHILD PROTECTION	12	120	0,085	0,00043	1,02	0,00516
2270 605 02XX	MEK+TUŞ TOPRAKLI PRİZ (Ç.K) SOCKET OUTLET WITH CHILD PROTECTION	12	120	0,095	0,00043	1,14	0,00516
2270 606 02XX	MEK+TUŞ TOPRAKSIZ PRİZ (Ç.K) EARTHED SOCKET WITH COVER	12	120	0,087	0,00043	1,044	0,00516
2270 610 02XX	MEK+TUŞ KAPAKLI TOPRAKLI PRİZ	12	120	0,1	0,00043	1,2	0,00516
2270 611 02XX	MEK+TUŞ KAPAKLI TOPRAKLI PRİZ (Ç.K)	12	120	0,102	0,00043	1,224	0,00516
2270 615 02XX	MEK+TUŞ UPS (FRANSIZ) PRİZ	12	120	0,094	0,00043	1,128	0,00516
2270 616 02XX	MEK+TUŞ UPS (FRANSIZ) PRİZ (Ç.K)	12	120	0,095	0,00043	1,14	0,00516
2270 617 02XX	MEK+TUŞ UPS KAPAKLI (FRANSIZ) PRİZ	12	120	0,1	0,00043	1,2	0,00516
2270 618 02XX	MEK+TUŞ UPS KAP. (FRANSIZ) PRİZ (Ç.K.)	12	120	0,102	0,00043	1,224	0,00516
2270 121 01XX	MEK+TUŞ TELEFON PRİZİ 2*RJ12	12	120	0,074	0,00043	0,888	0,00516
2270 448 01XX	MEK+TUŞ TEKLİ USB ŞARJ PRİZİ	8	80	0,1	0,00055	0,8	0,0044
2270 449 01XX	MEK+TUŞ TUŞ İKİLİ USB ŞARJ PRİZİ	8	80	0,101	0,00055	0,808	0,0044

İLETİŞİM GRUBU
COMMUNICATIONS GROUP

KOD CODE	ÜRÜN TANIMI DESCRIPTION	KUTU BOX	KOLİ PARCEL	BİRİM AĞIRLIK UNIT WEIGHT	BİRİM HACİM UNIT VOLUME	KUTU AĞIRLIK BOX WEIGHT	KUTU HACİM BOX VOLUME
2270 455 01XX	MEK+TUŞ DATA PRİZİ 1*USB VİDALI TELEPHONE SOCKET 1*RJ12 (CAT 3)	12	120	0,077	0,00043	0,924	0,00516
2270 456 01XX	MEK+TUŞ DATA PRİZİ 2*USB VİDALI	12	120	0,083	0,00043	0,996	0,00516
2270 457 01XX	MEK+TUŞ DATA PRİZİ 1*HDMI VİDALI	12	120	0,08	0,00043	0,96	0,00516
2270 458 01XX	MEK+TUŞ DATA PRİZİ 2*HDMI VİDALI	12	120	0,087	0,00043	1,044	0,00516
2270 459 01XX	MEK+TUŞ DATA PRİZİ 1*USB/1*HDMI VİDALI	12	120	0,085	0,00043	1,02	0,00516
2270 125 01XX	MEK+TUŞ TELEFON PRİZİ 1*RJ12 CAT3	12	120	0,081	0,00043	0,972	0,00516
2270 126 01XX	MEK+TUŞ TELEFON PRİZİ 2*RJ12 CAT3	12	120	0,089	0,00043	1,068	0,00516
2270 128 01XX	MEK+TUŞ ETİKETLİ TLF+DATA PRİZ (KON.SÜZ)	12	120	0,073	0,00043	0,876	0,00516
2270 135 01XX	MEK+TUŞ DATA PRİZİ 1*RJ45 (KON.SÜZ)	12	120	0,073	0,00043	0,876	0,00516
2270 136 01XX	MEK+TUŞ DATA PRİZİ 1*RJ45 (Cat5e)	12	120	0,081	0,00043	0,972	0,00516
2270 137 01XX	MEK+TUŞ DATA PRİZİ 2*RJ45 (KON.SÜZ)	12	120	0,073	0,00043	0,876	0,00516
2270 138 01XX	MEK+TUŞ DATA PRİZİ 2*RJ45 (Cat5e)	12	120	0,086	0,00043	1,032	0,00516
2270 139 01XX	MEK+TUŞ TLF+DATA PRİZ (RJ12+CAT5E)	12	120	0,089	0,00043	1,068	0,00516
2270 140 01XX	MEK+TUŞ DATA PRİZİ 1*RJ45 (CAT6E)	12	120	0,08	0,00043	0,96	0,00516
2270 141 01XX	MEK+TUŞ DATA PRİZİ 2*RJ45 (CAT6E)	12	120	0,088	0,00043	1,056	0,00516

TV/SAT GRUBU
TV/SAT GROUP

KOD CODE	ÜRÜN TANIMI DESCRIPTION	KUTU BOX	KOLİ PARCEL	BİRİM AĞIRLIK UNIT WEIGHT	BİRİM HACİM UNIT VOLUME	KUTU AĞIRLIK BOX WEIGHT	KUTU HACİM BOX VOLUME
2270 156 02XX	MEK+TUŞ TV-SAT PRİZİ (GEÇİŞLİ) 4dB/F Konnektör	12	120	0,101	0,00043	1,212	0,00516
2270 157 02XX	MEK+TUŞ TV-SAT PRİZİ (SONLU)	12	120	0,125	0,00043	1,5	0,00516
2270 161 02XX	MEK+TUŞ TV/R/SAT PRİZİ (SONLU)	12	120	0,104	0,00043	1,248	0,00516
2270 167 01XX	MEK+TUŞ SAT PRİZİ (SONLU)	12	120	0,101	0,00043	1,212	0,00516
2270 170 01XX	MEK+TUŞ TV PRİZİ (GEÇİŞLİ) 11dB	12	120	0,096	0,00043	1,152	0,00516
2270 171 01XX	MEK+TUŞ TV PRİZİ (SONLU)	12	120	0,096	0,00043	1,152	0,00516
2270 172 01XX	MEK+TUŞ TV PRİZİ F DİŞİ	12	120	0,081	0,00043	0,972	0,00516

Elitra

"Her DokunuŖta Zarafet, Her ereve de Dayanıklılık."
"Elegance in Every Touch, Durability in Every Frame."



Elitra alüminyum ereveli anahtar ve prizler, zarafeti ve dayanıklılığı bir araya getirerek, her mekana modern bir güzellik katıyor. Alüminyum erevesi, hem estetik açıdan hem de uzun ömürlü kullanım açısından üstün bir performans sunuyor.

Elitra aluminum-framed switches and sockets combine elegance and durability, adding modern beauty to any space. The aluminum frame offers superior performance both in terms of aesthetics and long-lasting use.



Glass **Elitra**



MILNER

Candelä

"Şıklık Parmađınızın Ucunda"
"Elegance at Your Fingertips"



ANAHTAR GRUBU VİDALI TİP SWITCH GROUP (WITH SCREW)



2125 401 02XX
Anahtar
Oneg. One Way Switch

2125 402 02XX
Komütatör
Twog. One Way Control

2125 403 02XX
Vavien (iki Yollu Anahtar)
Oneg. Two Way Switch

2125 404 02XX
Komütatör Vavien
Two Gang Two Way Switch

2125 405 02XX
Çift Kutuplu Anahtar
Oneg. One Way Dp

2125 406 02XX
Jaluzi Anahtar
Blind Switch -W/Spring

2125 407 02XX
Çağırma
One Gang One Way Control

2125 407 02XXX
Kapı Otomatığı Anahtar
Door Switch



2125 407 02XXZ
Zil Anahtar
Ring Switch

2125 408 02XX
Deviyatör(Ara Vavien)
Oneg. Intermediate-Deviator

2125 409 02XX
Üçlü Anahtar
3 Gang Switch

2125 411 02XX
Sofben Anahtarı
Heater Switch

2125 415 02XX
Işıklı Anahtar (220V)
Illu.1g.1w.Swi. (220v)

2125 416 02XX
Işıklı Vavien (220V)
Illu.Oneg. Two Way (220v)

2125 417 02XX
Işıklı Çağırma (220V)
Illu.1g.1w.Cntrl (220v)

2125 418 02XX
Işıklı Etik. Anahtar (220V)
Illu.1g.1w.W/Lab. (220v)

2125 419 02XX
Işıklı Etik. Çağırma (220V)
I.1g.1w.Cntrl/Lab. (220v)



2125 422 02XX
Işıklı Zil Etik. Çağırma (12V)
Illu.1g.1w.Cntrl (12v)

2125 426 02XX
Işıklı Komütatör
Illu.Twog. One Way Switch

2125 436 02XX
Jaluzi Anahtar (Yaysız - Vidalı)
Blind Switch (With Screw)

ANAHTAR GRUBU KLİPSLİ TİP (KOLAY BAĞLANTI) SWITCH GROUP (EASY CONNEX.)

2125 401 01XX
Anahtar
Oneg. One Way Switch

2125 402 01XX
Komütatör
Twog. One Way Control

2125 403 01XX
Vavien (iki Yollu Anahtar)
Oneg. Two Way Switch

2125 404 01XX
Komütatör Vavien
Two Gang Two Way Switch

2125 405 01XX
Çift Kutuplu Anahtar
Oneg. One Way Dp



2125 406 01XX
Jaluzi Anahtarı
Blind Switch -W/Spring

2125 407 01XX
Çağırma
One Gang One Way Control

2125 407 01XXX
Kapı Otomatığı Anahtar
Door Switch

2125 407 01XXZ
Zil Anahtar
Ring Switch

2125 408 01XX
Deviyatör(Ara Vavien)
Oneg. Intermediate-Deviator

2125 409 01XX
Üçlü Anahtar
3 Gang Switch

2125 415 01XX
Işıklı Anahtar (220V)
Illu.1g.1w.Swi. (220v)

2125 416 01XX
Işıklı Vavien (220V)
Illu.Oneg. Two Way (220v)

2125 417 01XX
Işıklı Çağırma (220V)
Illu.1g.1w.Cntrl (220v)

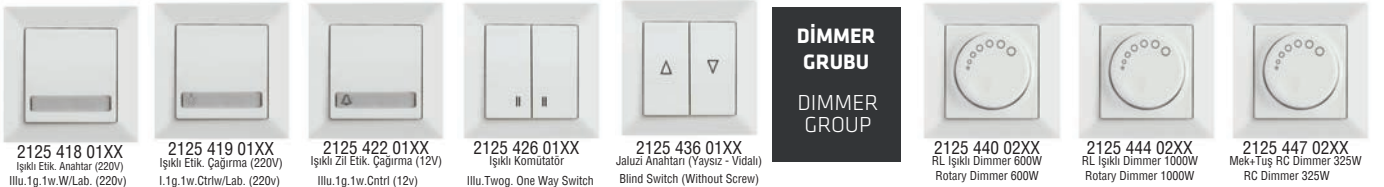

2125 418 01XX
Işıklı Etik. Anahtar (220V)
Illu.1g.1w.W/Lab. (220v)

2125 419 01XX
Işıklı Etik. Çağırma (220V)
I.1g.1w.Cntrl/Lab. (220v)

2125 422 01XX
Işıklı Zil Etik. Çağırma (12V)
Illu.1g.1w.Cntrl (12v)

2125 426 01XX
Işıklı Komütatör
Illu.Twog. One Way Switch

2125 436 01XX
Jaluzi Anahtar (Yaysız - Vidalı)
Blind Switch (Without Screw)

DİMMER GRUBU DIMMER GROUP

2125 440 02XX
RL Işıklı Dimmer 600W
Rotary Dimmer 600W

2125 444 02XX
RL Işıklı Dimmer 1000W
Rotary Dimmer 1000W

2125 447 02XX
Mek+Tuş RC Dimmer 325W
RC Dimmer 325W



ELEKTRONİK GRUBU ELECTRONICS GROUP

2125 450 01XX
Energy Saver G.siz Işıklı
Energy Saver Not Delay Illu.

2125 452 01XX
Energy Saver Gecikmeli Işıklı
Energy Saver Delay Illu.

2125 470 02XX
Müzik Yayın Anahtar
Audio Switch

2125 480 01XX
Hopariör Prizi
Speaker Socket

2125 485 02XX
Uyan Zili
Warning Bell

2125 495 02XX
Hareket Sensörü
Motion Sensor

PRİZ GRUBU SOCKET GROUP

2125 600 02XX
Topraklı Priz
Earthed Socket



2125 601 02XX
Topraksız Priz
Non Earthed Socket

2125 605 02XX
Topraklı Priz (Ç.K.)
Earthed Socket (Child Prot.)

2125 606 02XX
Topraksız Priz (Ç.K.)
Non Earthed Soc. (Child Prot.)

2125 610 02XX
Kapaklı Topraklı Priz
Earthed Socket With Cover

2125 611 02XX
Kapaklı Topraklı Priz (Ç. K.)
Earthed Soc. Cover (Child Prot.)

2125 615 02XX
Ups (Fransız) Prizi
Ups (French) Soc. (Earthed)

2125 616 02XX
Ups (Fransız) Priz (Ç. K.)
Ups (French) Socket (Child Prot.)

2125 617 02XX
Ups Kapaklı (Fransız) Priz
Ups (French) Soc. With Cover

2125 618 02XX
Ups Kapaklı (Fr.) Priz (Ç. K.)
Ups (French) Soc.W.Cover (C.P.)



2125 448 01XX
Tekli Usb Şarj Prizi
1*Usb Charger

2125 449 01XX
İkili Usb Şarj Prizi
2*Usb Charger

2125 200 02XX
İkili Topraklı Priz Porselen
Double Socket Earthed Porcelain

2125 201 02XX
İkili Topraksız Priz Porselen
Double Soc.Non Earthed Porcelain

2125 202 02XX
İkili Topraklı Priz
Double Socket Earthed

2125 203 02XX
İkili Topraksız Priz
Double Soc.Non Earthed

2125 215 02XX
İkili Ups Priz
Double Socket Ups



İLETİŞİM GRUBU
COMMUNICATION GROUP



2125 125 01XX
Telefon Prizi 1Xrj12 (Cat3)
Phonesocket 1'Rj12 (Cat3)



2125 126 01XX
Telefon Prizi 2Xrj12 (Cat3)
Telephone Soc.2xrj12



2125 128 01XX
Etikelli Tlf Data Priz (Kon.süz)
Tlf Data Soc.W/O Con. Label



2125 135 02XX
Data Prizi 1'Rj45 (Kon.süz)
Data Soc.1'Rj45w/Ocon.



2125 136 01XX
Data Prizi 1'Rj45 (Cat5e)
Data Soc.1'Rj45 (Cat5e)



2125 137 01XX
Data Prizi 2'Rj45 (Kon.süz)
Data Soc.2'Rj45w/Ocon.



2125 138 01XX
Data Prizi 2'Rj45 (Cat5e)
Data Soc.2'Rj45 (Cat5e)



2125 139 01XX
Tlf Data Priz (Rj12 Cat3 + Cat5e)
Tlf Data Soc.(Rj12 Cat5e)



2125 140 01XX
Data Prizi 1'Rj45 (Cat6)
Data Soc.1'Rj45 (Cat6)



2125 141 01XX
Data Prizi 2'Rj45 (Cat6)
Data Soc.2'Rj45 (Cat6)



2125 455 01XX
Data Prizi 1'Usb
Data Soc.1'Usb



2125 456 01XX
Data Prizi 2'Usb
Data Soc.2'Usb



2125 457 01XX
Data Prizi 1'Hdmi
Data Soc.1'Hdmi



2125 458 01XX
Data Prizi 2'Hdmi
Data Soc.2'Hdmi



2125 459 01XX
Data Prizi 1'Usb/1'Hdmi
Data Soc. 1'Usb/1'Hdmi



2125 460 01XX
VGA Priz
Switch Vga Socket



2125 121 02XX
Kör Kapak
Blind Cover White

TV / SAT GRUBU
TV / SAT GROUP



2125 156 02XX
Tv-Sat Prizi (Geçişli) 4dB/F Kon.
Tv-Sat Soc.Thr.4db/Fcon.



2125 157 02XX
Tv-Sat Prizi (Somlu)
Tv-Sat Soc.(Dead End)



2125 166 01XX
Sat Prizi (Geçişli) 4dB/F Kon.
Sat Soc.(Through)4db/Fcon.



2125 167 01XX
Sat Prizi (Somlu)
Sat Soc.(Dead End)



2125 170 01XX
Tv Prizi (Geçişli) 11dB
Tv Socket (Thr) 11db



2125 171 01XX
Tv Prizi (Somlu)
Tv Soc.(Dead End) 11db



2125 172 01XX
Tv Prizi F Dişi
Tv Socket F Female



Candelä

"Uzun Ömürlü ve Güvenli Kullanım"
"Long Lasting and Safe Use"



RENK SEÇENEKLERİ COLOR OPTIONS

METALİK METALLIC



XX:80 Antik Altın
Antique gold



XX:82 İnox
Inox



XX:83 Titanyum
Titanium



XX:84 Siyah
Black



XX:85 Dore
Dore



XX:86 Antrasit
Anthracite



XX:95 Füme
Smoked

NATUREL NATURAL



XX:01 Beyaz White



XX:02 Krem Cream

AHŞAP DESEN WOOD PATTERN



XX:56 Kiraz
Cherry

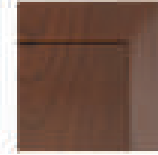

XX:57 Ceviz
Walnuts

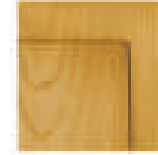

XX:58 Meşe
Oak

YATAY ÇERÇEVELER HORIZONTAL FRAMES



2125 800 11XX
1'li Çerçeve 1 Gang frame



2125 800 12XX
2'li Çerçeve 2 Gang frame



2125 820 12XX
2'li Priz Çerçeve
Double Socket frame



2125 800 13XX
3'lü Çerçeve 3 Gang frame



2125 800 14XX
4'lü Çerçeve 4 Gang frame

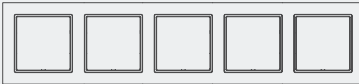

2125 800 15XX
5'li Çerçeve 5 Gang frame



2125 800 16XX
6'li Çerçeve 6 Gang frame

DİKEY ÇERÇEVELER VERTICAL FRAMES

2125 800 22XX
2'li Çerçeve
2 Gang frame



2125 800 23XX
3'lü Çerçeve
3 Gang frame



2125 800 24XX
4'lü Çerçeve
4 Gang frame



2125 800 25XX
5'li Çerçeve
5 Gang frame



2125 800 26XX
6'li Çerçeve
6 Gang frame



Bu ürün kodlarında **XX** çerçeve rengini belirtmektedir.
XX specify frame color for these products.

Candela



"Elegant Touches to Your Living Space"



"Yaşam Alanınıza Şık Dokunuşlar"

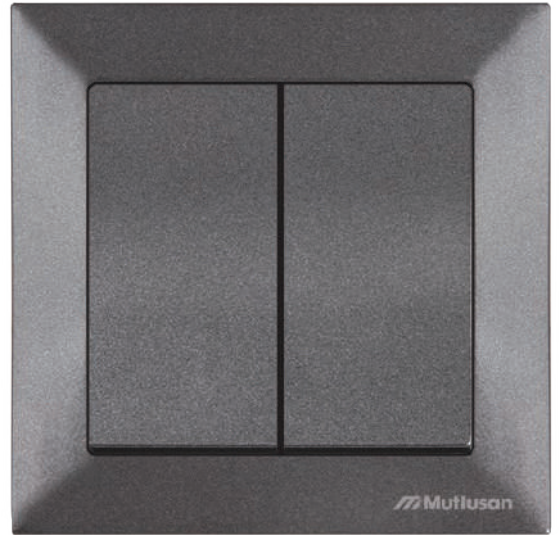
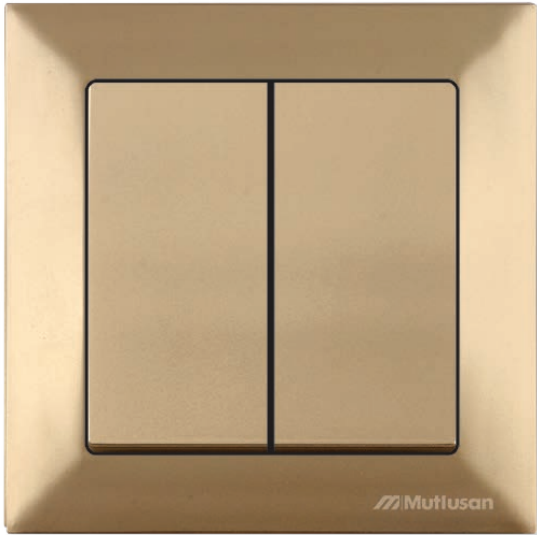

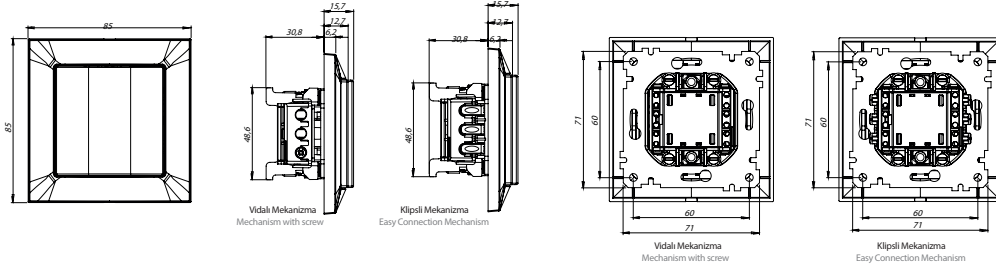

MEKANİZMA + TUŞ ÜRÜN LİSTESİ • MECHANISM + SWITCH PRODUCT LIST

ANAHTAR GRUBU VİDALI SWITCH GROUP (WITH SCREW)

KOD CODE	ÜRÜN TANIMI DESCRIPTION	KUTU BOX	KOLİ PARCEL	BİRİM AĞIRLIK UNIT WEIGHT	BİRİM HACİM UNIT VOLUME	KUTU AĞIRLIK BOX WEIGHT	KUTU HACİM BOX VOLUME
2100 401 02XX	MEK+TUŞ ANAHTAR (VİDALI)	12	120	0,09	0,00037	1,08	0,00444
2100 402 02XX	MEK+TUŞ KOMÜTATÖR (VİDALI)	12	120	0,091	0,00037	1,092	0,00444
2100 403 02XX	MEK+TUŞ VAVİEN(İKİ YOLLU ANAHTAR) (VİDALI)	12	120	0,091	0,00037	1,092	0,00444
2100 404 02XX	MEK+TUŞ KOMÜTATÖR VAVİEN (VİDALI)	12	120	0,0964	0,00037	1,1568	0,00444
2100 405 02XX	MEK+TUŞ ÇİFT KUTUPLU ANAHTAR (VİDALI)	12	120	0,0942	0,00037	1,1304	0,00444
2100 406 02XX	MEK+TUŞ JALUZİ ANAHTARI (VİDALI) -YAYLI	12	120	0,0928	0,00037	1,1136	0,00444
2100 407 02XX	MEK+TUŞ ÇAĞIRMA (VİDALI)	12	120	0,0886	0,00037	1,0632	0,00444
2100 407 02XXK	MEK+TUŞ KAPI OTOMATIĞI ANAHTARI (VİDALI)	12	120	0,0886	0,00037	1,0632	0,00444
2100 407 02XXZ	MEK+TUŞ ZİL ANAHTARI (VİDALI)	12	120	0,0886	0,00037	1,0632	0,00444
2100 408 02XX	MEK+TUŞ DEVIATÖR (ARA VAVİEN) (VİDALI)	12	120	0,0929	0,00037	1,1148	0,00444
2100 409 02XX	MEK+TUŞ ÜÇLÜ ANAHTAR (VİDALI)	12	120	0,096	0,00037	1,152	0,00444
2100 411 02XX	MEK+TUŞ MEK TUŞ ŞOFBEN ANAHTARI (VİDALI)	12	120	0,0796	0,00037	0,9552	0,00444
2100 415 02XX	MEK+TUŞ IŞIKLI ANAHTAR (VİDALI)	12	120	0,0908	0,00037	1,0896	0,00444
2100 416 02XX	MEK+TUŞ IŞIKLI VAVİEN (VİDALI)	12	120	0,093	0,00037	1,116	0,00444
2100 417 02XX	MEK+TUŞ IŞIKLI ÇAĞIRMA (220V) (VİDALI)	12	120	0,0908	0,00037	1,0896	0,00444
2100 418 02XX	MEK+TUŞ IŞIKLI ETİK. ANAHTAR (VİDALI)	12	120	0,0908	0,00037	1,0896	0,00444
2100 419 02XX	MEK+TUŞ IŞIKLI ETİK. ÇAĞIRMA (VİDALI)	12	120	0,0896	0,00037	1,0752	0,00444
2100 422 02XX	MEK+TUŞ IŞIKLI ZİL ETİKETLİ ÇAĞIRMA (12V) (VİDALI)	12	120	0,0896	0,00037	1,0752	0,00444
2100 426 02XX	MEK+TUŞ IŞIKLI KOMÜTATÖR (VİDALI)	12	120	0,0892	0,00037	1,0704	0,00444
2100 436 02XX	MEK+TUŞ JALUZİ ANAHTARI (YAYSIZ) (VİDALI)	12	120	0,093	0,00037	1,116	0,00444

ANAHTAR GRUBU KLİPSLİ SWITCH GROUP EASY CONNECTION

KOD CODE	ÜRÜN TANIMI DESCRIPTION	KUTU BOX	KOLİ PARCEL	BİRİM AĞIRLIK UNIT WEIGHT	BİRİM HACİM UNIT VOLUME	KUTU AĞIRLIK BOX WEIGHT	KUTU HACİM BOX VOLUME
2100 401 01XX	MEK+TUŞ ANAHTAR (KLİPSLİ)	12	120	0,087	0,00037	1,044	0,00444
2100 402 01XX	MEK+TUŞ KOMÜTATÖR (KLİPSLİ)	12	120	0,0895	0,00037	1,074	0,00444
2100 403 01XX	MEK+TUŞ VAVİEN(İKİ YOLLU ANAHTAR) (KLİPSLİ)	12	120	0,0888	0,00037	1,0656	0,00444
2100 404 01XX	MEK+TUŞ KOMÜTATÖR VAVİEN (KLİPSLİ)	12	120	0,0915	0,00037	1,098	0,00444
2100 405 01XX	MEK+TUŞ ÇİFT KUTUPLU ANAHTAR (KLİPSLİ)	12	120	0,0908	0,00037	1,0896	0,00444
2100 406 01XX	MEK+TUŞ JALUZİ ANAHTARI (KLİPSLİ) -YAYLI	12	120	0,0908	0,00037	1,0896	0,00444
2100 407 01XX	MEK+TUŞ ÇAĞIRMA (KLİPSLİ)	12	120	0,0857	0,00037	1,0284	0,00444
2100 407 01XXK	MEK+TUŞ KAPI OTOMATIĞI ANAHTARI (KLİPSLİ)	12	120	0,0857	0,00037	1,0284	0,00444
2100 407 01XXZ	MEK+TUŞ ZİL ANAHTARI (KLİPSLİ)	12	120	0,0857	0,00037	1,0284	0,00444
2100 408 01XX	MEK+TUŞ DEVIATÖR (ARA VAVİEN) (KLİPSLİ)	12	120	0,0906	0,00037	1,0872	0,00444
2100 409 01XX	MEK+TUŞ ÜÇLÜ ANAHTAR (KLİPSLİ)	12	120	0,0909	0,00037	1,0908	0,00444
2100 415 01XX	MEK+TUŞ IŞIKLI ANAHTAR (KLİPSLİ)	12	120	0,0892	0,00037	1,0704	0,00444
2100 416 01XX	MEK+TUŞ IŞIKLI VAVİEN (KLİPSLİ)	12	120	0,09	0,00037	1,08	0,00444
2100 417 01XX	MEK+TUŞ IŞIKLI ÇAĞIRMA (220V) (KLİPSLİ)	12	120	0,0896	0,00037	1,0752	0,00444
2100 418 01XX	MEK+TUŞ IŞIKLI ETİK. ANAHTAR (KLİPSLİ)	12	120	0,0896	0,00037	1,0752	0,00444
2100 419 01XX	MEK+TUŞ IŞIKLI ETİK. ÇAĞIRMA (KLİPSLİ)	12	120	0,0896	0,00037	1,0752	0,00444
2100 422 01XX	MEK+TUŞ IŞIKLI ZİL ETİKETLİ ÇAĞIRMA (12V) (KLİPSLİ)	12	120	0,0896	0,00037	1,0752	0,00444
2100 426 01XX	MEK+TUŞ IŞIKLI KOMÜTATÖR (KLİPSLİ)	12	120	0,0858	0,00037	1,0296	0,00444
2100 436 01XX	MEK+TUŞ JALUZİ ANAHTARI (YAYSIZ) (KLİPSLİ)	12	120	0,091	0,00037	1,092	0,00444

DİMMER GRUBU DIMMER GROUP

KOD CODE	ÜRÜN TANIMI DESCRIPTION	KUTU BOX	KOLİ PARCEL	BİRİM AĞIRLIK UNIT WEIGHT	BİRİM HACİM UNIT VOLUME	KUTU AĞIRLIK BOX WEIGHT	KUTU HACİM BOX VOLUME
2100 440 02XX	MEK+TUŞ RL IŞIKLI DİMMER 600W	8	80	0,1011	0,00055	0,8088	0,0044
2100 444 02XX	MEK+TUŞ RL IŞIKLI DİMMER 1000W	8	80	0,1116	0,00055	0,8928	0,0044
2100 447 02XX	MEK+TUŞ RC DİMMER 325W	8	80	0,101	0,00055	0,808	0,0044

İNGİLİZ TİPİ ANAHTAR PRİZ BRITISH TYPE SWITCH SOCKET

2190 500 0201	İNGİLİZ TİPİ ANAHTARLI PRİZ BEYAZ	12	120	0,1	0,00038688	1,2	0,00464256
---------------	-----------------------------------	----	-----	-----	------------	-----	------------

MEKANİZMA + TUŞ ÜRÜN LİSTESİ • MECHANISM + SWITCH PRODUCT LIST

ELEKTRONİK GRUBU ELECTRONIC GROUP

KOD CODE	ÜRÜN TANIMI DESCRIPTION	KUTU BOX	KOLİ PARCEL	BİRİM AĞIRLIK UNIT WEIGHT	BİRİM HACİM UNIT VOLUME	KUTU AĞIRLIK BOX WEIGHT	KUTU HACİM BOX VOLUME
2100 450 01XX	MEK+TUŞ ENERGY SAVER G.SİZ IŞIKLI	8	80	0,104	0,00055	0,832	0,0044
2100 452 01XX	MEK TUŞ ENERGY SAVER GEÇİKMELİ	8	80	0,106	0,00055	0,848	0,0044
2100 470 02XX	MEK+TUŞ MÜZİK YAYIN ANAHTARI	8	80	0,0956	0,00055	0,7648	0,0044
2100 480 01XX	MEK+TUŞ HOPARLÖR PRİZİ	12	120	0,069	0,00037	0,828	0,00444
2100 485 02XX	MEK+TUŞ UYARI ZİLİ	8	80	0,097	0,00055	0,776	0,0044
2100 495 02XX	MEK+TUŞ HAREKET SENSÖRÜ	8	0	0,104	0,00055	0,832	0,0044

PRİZ GRUBU SOCKET GROUP

KOD CODE	ÜRÜN TANIMI DESCRIPTION	KUTU BOX	KOLİ PARCEL	BİRİM AĞIRLIK UNIT WEIGHT	BİRİM HACİM UNIT VOLUME	KUTU AĞIRLIK BOX WEIGHT	KUTU HACİM BOX VOLUME
2100 600 02XX	MEK+TUŞ TOPRAKLI PRİZ	12	120	0,081	0,00037	0,972	0,00444
2100 601 02XX	MEK+TUŞ TOPRAKSIZ PRİZ	12	120	0,073	0,00037	0,876	0,00444
2100 605 02XX	MEK+TUŞ TOPRAKLI PRİZ (Ç.K.)	12	120	0,084	0,00037	1,008	0,00444
2100 606 02XX	MEK+TUŞ TOPRAKSIZ PRİZ (Ç.K.)	12	120	0,075	0,00037	0,9	0,00444
2100 610 02XX	MEK+TUŞ KAPAKLI TOPRAKLI PRİZ	12	120	0,087	0,00037	1,044	0,00444
2100 611 02XX	MEK+TUŞ KAPAKLI TOPRAKLI PRİZ (Ç.K.)	12	120	0,0893	0,00037	1,0716	0,00444
2100 615 02XX	MEK+TUŞ UPS (FRANSIZ) PRİZİ	12	120	0,082	0,00037	0,984	0,00444
2100 616 02XX	MEK+TUŞ UPS (FRANSIZ) PRİZ (Ç.K.)	12	120	0,0831	0,00037	0,9972	0,00444
2100 617 02XX	MEK+TUŞ MEK TUŞ UPS KAPAKLI (FRANSIZ) PRİZ	12	120	0,0884	0,00037	1,0608	0,00444
2100 618 02XX	MEK+TUŞ UPS KAPAKLI (FRANSIZ) PRİZ (Ç.K.)	12	120	0,0902	0,00037	1,0824	0,00444
2100 200 02XX	MEK+TUŞ İKİLİ TOPRAKLI PRİZ PORSELEN	5	50	0,1851	0,00088	0,9255	0,0044
2100 201 02XX	MEK+TUŞ İKİLİ PRİZ PORSELEN	5	50	0,1511	0,00088	0,7555	0,0044
2100 202 02XX	MEK+TUŞ MEK TUŞ İKİLİ TOPRAKLI PRİZ	5	50	0,1192	0,00088	0,596	0,0044
2100 203 02XX	MEK+TUŞ MEK.+TUŞ İKİLİ TOPRAKSIZ PRİZ	5	50	0,124	0,00088	0,62	0,0044
2100 215 02XX	MEK. TUŞ İKİLİ UPS PRİZ	5	50	0,1016	0,00088	0,508	0,0044
2100 448 01XX	MEK+TUŞ TEKLİ USB ŞARJ PRİZİ	8	80	0,1	0,00055	0,8	0,0044
2100 449 01XX	MEK+TUŞ İKİLİ USB ŞARJ PRİZİ	8	80	0,101	0,00055	0,808	0,0044

PRİZ GRUBU SOCKET GROUP

KOD CODE	ÜRÜN TANIMI DESCRIPTION	KUTU BOX	KOLİ PARCEL	BİRİM AĞIRLIK UNIT WEIGHT	BİRİM HACİM UNIT VOLUME	KUTU AĞIRLIK BOX WEIGHT	KUTU HACİM BOX VOLUME
2100 125 01XX	MEK+TUŞ TELEFON PRİZİ 1*RJ12 (CAT3)	12	120	0,069	0,00037	0,828	0,00444
2100 126 01XX	MEK+TUŞ TELEFON PRİZİ 2*RJ12 (CAT3)	12	120	0,0777	0,00037	0,9324	0,00444
2100 128 01XX	MEK+TUŞ ETİKETLİ TLF+DATA PRİZ (KON.SÜZ)	12	120	0,0634	0,00037	0,7608	0,00444
2100 135 01XX	MEK+TUŞ DATA PRİZİ 1*RJ45 (KON.SÜZ)	12	120	0,0615	0,00037	0,738	0,00444
2100 136 01XX	MEK+TUŞ DATA PRİZİ 1*RJ45 (CAT5E)	12	120	0,0702	0,00037	0,8424	0,00444
2100 137 01XX	MEK+TUŞ DATA PRİZİ 2*RJ45 (KON.SÜZ)	12	120	0,0615	0,00037	0,738	0,00444
2100 138 01XX	MEK+TUŞ DATA PRİZİ 2*RJ45 (CAT5E)	12	120	0,0777	0,00037	0,9324	0,00444
2100 139 01XX	MEK+TUŞ TELEFON DATA PRİZİ (RJ12 CAT3 + CAT5E)	12	120	0,0769	0,00037	0,9228	0,00444
2100 140 01XX	MEK+TUŞ DATA PRİZİ 1*RJ45 (CAT6)	12	120	0,068	0,00037	0,816	0,00444
2100 141 01XX	MEK+TUŞ DATA PRİZİ 2*RJ45 (Cat6)	12	120	0,0764	0,00037	0,9168	0,00444
2100 455 01XX	MEK TUŞ DATA PRİZİ 1*USB	5	50	0,066	0,00037	0,792	0,00444
2100 456 01XX	MEK+TUŞ DATA PRİZİ 2*USB	5	50	0,072	0,00037	0,864	0,00444
2100 457 01XX	MEK TUŞ DATA PRİZİ 1*HDMI	5	50	0,0668	0,00037	0,8016	0,00444
2100 458 01XX	MEK+TUŞ DATA PRİZİ 2*HDMI	5	50	0,074	0,00037	0,888	0,00444
2100 459 01XX	MEK+TUŞ DATA PRİZİ 1*USB/1*HDMI	5	50	0,073	0,00037	0,876	0,00444
2100 460 01XX	MEK+TUŞ VGA PRİZİ	8	80	0,073	0,00037	0,876	0,00444
2100 121 01XX	MEK+TUŞ KÖR KAPAK	8	80	0,0611	0,00037	0,7332	0,00444

TV/SAT GRUBU TV/SAT GROUP

KOD CODE	ÜRÜN TANIMI DESCRIPTION	KUTU BOX	KOLİ PARCEL	BİRİM AĞIRLIK UNIT WEIGHT	BİRİM HACİM UNIT VOLUME	KUTU AĞIRLIK BOX WEIGHT	KUTU HACİM BOX VOLUME
2100 156 02XX	MEK+TUŞ TV/SAT PRİZİ (GEÇİŞLİ)	12	120	0,0899	0,00037	1,0788	0,00444
2100 157 02XX	MEK+TUŞ TV-SAT PRİZİ (SONLU)	12	120	0,1135	0,00037	1,362	0,00444
2100 166 01XX	MEK+TUŞ SAT PRİZİ (GEÇİŞLİ) 4DB/F KONNEKTÖR	12	120	0,0886	0,00037	1,0632	0,00444
2100 167 01XX	MEK+TUŞ SAT PRİZİ (SONLU)	12	120	0,0904	0,00037	1,0848	0,00444
2100 170 01XX	MEK+TUŞ TV PRİZİ (GEÇİŞLİ) 11DB	12	120	0,0843	0,00037	1,0116	0,00444
2100 171 01XX	MEK+TUŞ TV PRİZİ (SONLU)	12	120	0,0855	0,00037	1,026	0,00444
2100 172 01XX	MEK+TUŞ TV PRİZİ F DİŞİ	12	120	0,069	0,00037	0,828	0,00444



SERISI

IP54

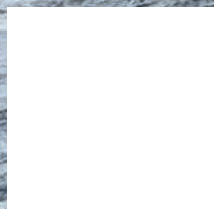

YENİ
NEW



NEMLİYER

"Nemli Ortamların Güvencesi"

"Assurance of Humid Environments"

YENİ
NEW

Zorlu ortamlarda dahi güvenle kullanılabilen seri, suya dayanıklı yapısı ve şık tasarımı

The series, which can be used safely even in harsh environments, has a water-resistant structure and stylish design.



IP54

NORA BELLA

SERİSİ SERIES



NORA

Yaşam Alanlarında Yeni Moda

Yeni Nemliyer serisi Nora, modern tasarımı ve güvenli kullanım özellikleri ile yaşam alanlarına değer katıyor.

Beyaz ve gri renk seçenekleriyle sunulan Nora, IP54 özelliği sayesinde toza ve neme karşı dayanıklılık ve uzun kullanım ömrü olanağı sağlıyor.

New Fashion in Living Spaces

The new moisture series Nora, add value to living spaces with their modern design and safe usage features.

Available in white and grey colour options, Nora provide dust and moisture resistance and long service life thanks to IP54 feature.

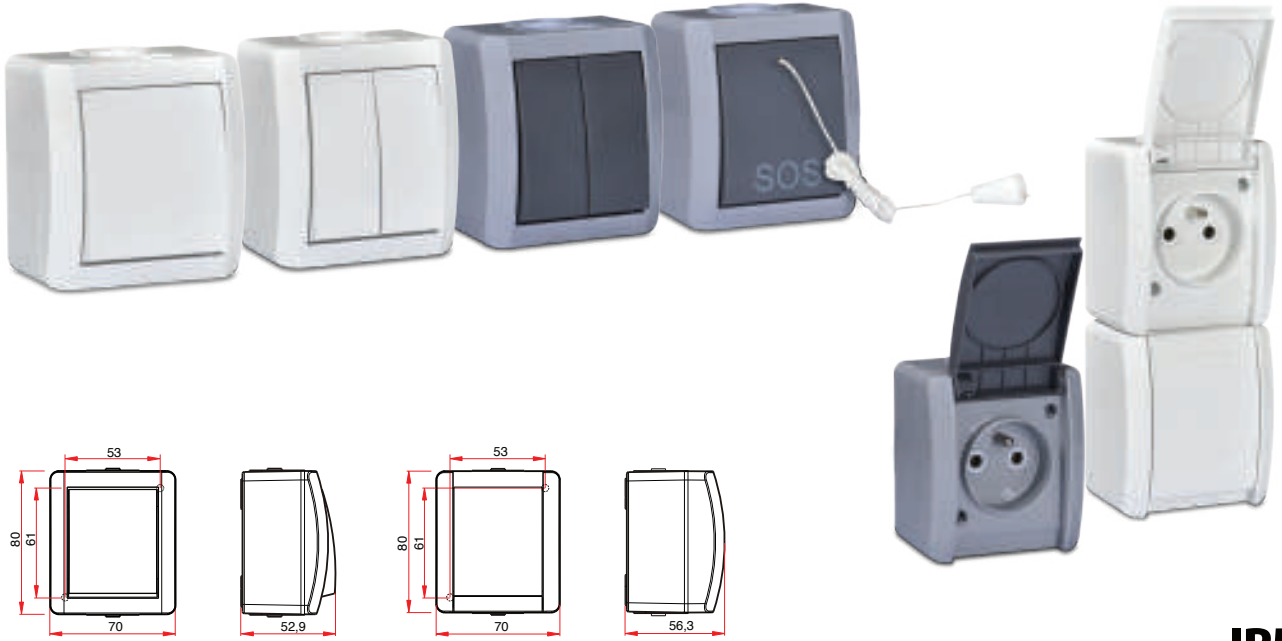

IP54

ANAHTAR GRUBU SWITCH GROUP

KOD CODE	ÜRÜN TANIMI DESCRIPTION	KUTU BOX	KOLİ PARCEL	BİRİM AĞIRLIK UNIT WEIGHT	BİRİM HACİM UNIT VOLUME	KUTU AĞIRLIK BOX WEIGHT	KUTU HACİM BOX VOLUME
2155 001 02XX	ANAHTAR	8	80	0,09888	0,00044	0,79104	0,00352
2155 002 02XX	KOMÜTATÖR	8	80	0,103	0,00044	0,824	0,00352
2155 003 02XX	VAVİEN (İKİ YÖNLÜ ANAHTAR)	8	80	0,10292	0,00044	0,82336	0,00352
2155 004 02XX	KOMÜTATÖR VAVİEN	8	80	10292	0,00038688	82336	0,00309504
2155 005 02XX	ÇİFT KUTUPLU ANAHTAR	8	80	0,10083	0,00044	0,80664	0,00352
2155 007 02XX	ÇAĞIRMA ANAHTARI	8	80	0,09865	0,00044	0,7892	0,00352
2155 007 02XXZ	ZİL ANAHTARI	8	80	0,098	0,00044	0,784	0,00352
2155 008 02XX	DEVİYATÖR (ARA VAVİEN)	8	80	0,10083	0,00044	0,80664	0,00352
2155 037 02XX	ACİL ÇAĞIRMA (İPLİ)	8	80	0,09875	0,00044	0,79	0,00352

PRİZ GRUBU SOCKET GROUP

KOD CODE	ÜRÜN TANIMI DESCRIPTION	KUTU BOX	KOLİ PARCEL	BİRİM AĞIRLIK UNIT WEIGHT	BİRİM HACİM UNIT VOLUME	KUTU AĞIRLIK BOX WEIGHT	KUTU HACİM BOX VOLUME
2155 180 02XX	KAPAKLI TOPRAKLI PRİZ	8	80	0,10638	0,00055	0,85104	0,0044
2155 187 02XX	KAPAKLI TOPRAKLI UPS PRİZ	8	80	0,11877	0,00044	0,95016	0,00352
2155 188 02XX	KAPAKLI TOPRAKLI UPS PRİZ (Ç.K)	8	80	0,099	0,00044	0,792	0,00352
2155 210 02XX	KAPAKLI TOPRAKLI İKİLİ PRİZ	4	40	0,17325	0,00055	0,693	0,0022
2155 217 02XX	KAPAKLI TOPRAKLI İKİLİ UPS PRİZ	4	40	0,21513	0,00044	0,86052	0,00176
2155 220 02XX	KAPAKLI TOPRAKLI İKİLİ DİKEY PRİZ	4	40	0,117	0,00055	0,468	0,0022
2155 227 02XX	KAPAKLI TOPRAKLI İKİLİ DİKEY UPS PRİZ	4	40	0,099	0,00044	0,396	0,00176
2155 511 02XX	İKİLİ ANAHTAR+TOPRAKLI PRİZ	4	40	0,099	0,00044	0,396	0,00176
2155 521 02XX	İKİLİ KOMÜTATÖR+TOPRAKLI PRİZ	4	40	0,099	0,00044	0,396	0,00176

BUAT BUAT

KOD CODE	ÜRÜN TANIMI DESCRIPTION	KUTU BOX	KOLİ PARCEL	BİRİM AĞIRLIK UNIT WEIGHT	BİRİM HACİM UNIT VOLUME	KUTU AĞIRLIK BOX WEIGHT	KUTU HACİM BOX VOLUME
2155 000 01XX	4 ÇIKIŞ BUAT	8	80	0,098	0,00044	0,784	0,00352

BELLA

Yaşam Alanlarında Yeni Moda

Yeni Nemliyer serisi Bella, modern tasarımı ve güvenli kullanım özellikleri ile yaşam alanlarına değer katıyor.

Beyaz ve gri renk seçenekleriyle sunulan Bella, IP54 özelliği sayesinde toza ve neme karşı dayanıklılık ve uzun kullanım ömrü olanağı sağlıyor.

New Fashion in Living Spaces

The new moisture series Bella, add value to living spaces with their modern design and safe usage features.

Available in white and grey colour options, Bella provide dust and moisture resistance and long service life thanks to IP54 feature.

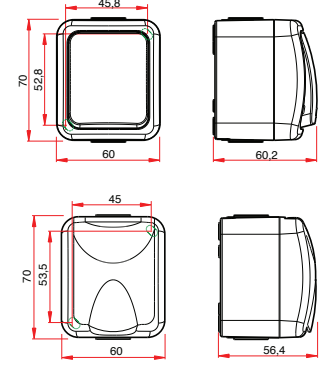

IP54

ANAHTAR GRUBU SWITCH GROUP

KOD CODE	ÜRÜN TANIMI DESCRIPTION	KUTU BOX	KOLİ PARCEL	BİRİM AĞIRLIK UNIT WEIGHT	BİRİM HACİM UNIT VOLUME	KUTU AĞIRLIK BOX WEIGHT	KUTU HACİM BOX VOLUME
2151 001 02XX	ANAHTAR	8	80	0,099	0,00044	0,792	0,00352
2151 002 02XX	KOMÜTATÖR	8	80	0,101	0,00044	0,808	0,00352
2151 003 02XX	VAVİEN (İKİ YÖNLÜ ANAHTAR)	8	80	0,1	0,00044	0,8	0,00352
2151 005 02XX	ÇİFT KUTUPLU ANAHTAR	8	80	0,08878	0,00044	0,71024	0,00352
2151 006 02XX	JALUZİ ANAHTARI	8	80	0,09308	0,00044	0,74464	0,00352
2151 007 02XXK	KAPI OTOMATİĞİ ANAHTARI	8	80	0,084	0,00044	0,672	0,00352
2151 007 02XXZ	ZİL ANAHTARI	8	80	0,084	0,00044	0,672	0,00352
2151 007 02XX	ÇAĞIRMA ANAHTARI	8	80	0,084	0,00044	0,672	0,00352
2151 008 02XX	DEVİYATÖR (ARA VAVİEN)	8	80	0,09081	0,00044	0,72648	0,00352

PRİZ GRUBU SOCKET GROUP

KOD CODE	ÜRÜN TANIMI DESCRIPTION	KUTU BOX	KOLİ PARCEL	BİRİM AĞIRLIK UNIT WEIGHT	BİRİM HACİM UNIT VOLUME	KUTU AĞIRLIK BOX WEIGHT	KUTU HACİM BOX VOLUME
2151 180 02XX	KAPAKLI TOPRAKLI PRİZ	8	80	0,087	0,00055	0,696	0,0044
2151 210 02XX	KAPAKLI TOPRAKLI İKİLİ PRİZ	4	40	0,117	0,00055	0,468	0,0022
2151 220 02XX	KAPAKLI TOPRAKLI İKİLİ DİKEY PRİZ	4	40	0,117	0,00055	0,468	0,0022
2151 511 02XX	İKİLİ ANAHTAR+TOPRAKLI PRİZ	4	40	0,099	0,00044	0,396	0,00176
2151 521 02XX	İKİLİ KOMÜTATÖR+TOPRAKLI PRİZ	4	40	0,099	0,00044	0,396	0,00176

BUAT BUAT

2155 000 01XX	6 ÇIKIŞ BUAT	8	80	0,098	0,00044	0,784	0,00352
---------------	--------------	---	----	-------	---------	-------	---------

AHŞAP/ANAHTAR GRUBU WOOD SWITCH GROUP

KOD CODE	ÜRÜN TANIMI DESCRIPTION	KUTU BOX	KOLİ PARCEL	BİRİM AĞIRLIK UNIT WEIGHT	BİRİM HACİM UNIT VOLUME	KUTU AĞIRLIK BOX WEIGHT	KUTU HACİM BOX VOLUME
2151 001 02XX	ANAHTAR	8	80	0,099	0,00044	0,792	0,00352
2151 002 02XX	KOMÜTATÖR	8	80	0,101	0,00044	0,808	0,00352
2151 003 02XX	VAVİEN (İKİ YÖNLÜ ANAHTAR)	8	80	0,1	0,00044	0,8	0,00352
2151 005 02XX	ÇİFT KUTUPLU ANAHTAR	8	80	0,08878	0,00044	0,71024	0,00352
2151 006 02XX	JALUZİ ANAHTARI	8	80	0,09308	0,00044	0,74464	0,00352
2151 007 02XXK	KAPI OTOMATİĞİ ANAHTARI	8	80	0,084	0,00044	0,672	0,00352
2151 007 02XXZ	ZİL ANAHTARI	8	80	0,084	0,00044	0,672	0,00352
2151 007 02XX	ÇAĞIRMA ANAHTARI	8	80	0,084	0,00044	0,672	0,00352

AHŞAP/PRİZ GRUBU WOOD SOCKET GROUP

KOD CODE	ÜRÜN TANIMI DESCRIPTION	KUTU BOX	KOLİ PARCEL	BİRİM AĞIRLIK UNIT WEIGHT	BİRİM HACİM UNIT VOLUME	KUTU AĞIRLIK BOX WEIGHT	KUTU HACİM BOX VOLUME
2151 180 02XX	KAPAKLI TOPRAKLI PRİZ	8	80	0,087	0,00055	0,696	0,0044
2151 210 02XX	KAPAKLI TOPRAKLI İKİLİ PRİZ	4	40	0,117	0,00055	0,468	0,0022
2151 220 02XX	KAPAKLI TOPRAKLI İKİLİ DİKEY PRİZ	4	40	0,117	0,00055	0,468	0,0022
2151 511 02XX	İKİLİ ANAHTAR+TOPRAKLI PRİZ	4	40	0,099	0,00044	0,396	0,00176
2151 521 02XX	İKİLİ KOMÜTATÖR+TOPRAKLI PRİZ	4	40	0,099	0,00044	0,396	0,00176

BUAT BUAT

2155 000 01XX	6 ÇIKIŞ BUAT	8	80	0,098	0,00044	0,784	0,00352
---------------	--------------	---	----	-------	---------	-------	---------

YENİ
NEW



BELLA

"Zor Yüzeyler İçin Kolay Çözüm: Nemliyer"

"Easy Solution for Difficult Surfaces: Nemliyer"

BRON SERİSİ

SERIES



Her yüzeyde kolay montaj imkanı sunarak, estetik ve dayanıklılığı bir arada sağlar. Her ortama mükemmel uyum sağlayan bu ürün, üstün performansı ile mekanlarınızın vazgeçilmezi olacak.

It provides easy installation on any surface, providing aesthetics and durability together. This product, which fits perfectly into any environment, will be indispensable for your spaces with its superior performance.



RENK SEÇENEKLERİ • COLOR OPTIONS



XX:01 Beyaz
White



XX:02 Krem
Ivory



XX:57 Ceviz
Walnuts



XX:58 Meşe
Oak

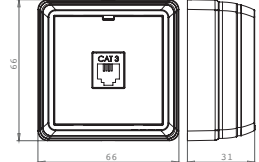
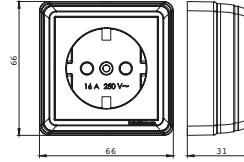
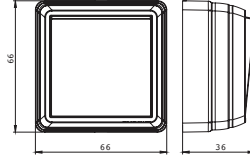

BRON NATURAL ÜRÜN GRUBU NATURAL PRODUCT GROUP

KOD CODE	ÜRÜN TANIMI DESCRIPTION	KUTU BOX	KOLİ PARCEL	BİRİM AĞIRLIK UNIT WEIGHT	BİRİM HACİM UNIT VOLUME	KUTU AĞIRLIK BOX WEIGHT	KUTU HACİM BOX VOLUME
2160 301 02XX	BRON S/Ü ANAHTAR	12	120	0,066	0,00037	0,792	0,00444
2160 302 02XX	BRON S/Ü KOMÜTATÖR	12	120	0,069	0,00037	0,828	0,00444
2160 303 02XX	BRON S/Ü VAVİEN	12	120	0,068	0,00037	0,816	0,00444
2160 307 02XX	BRON S/Ü LIGHT (ÇAĞIRMA)	12	120	0,066	0,00037	0,792	0,00444
2160 315 02XX	BRON S/Ü IŞIKLI ANAHTAR (220V)	12	120	0,067	0,00037	0,804	0,00444
2160 316 02XX	BRON S/Ü IŞIKLI VAVİEN (220V)	12	120	0,069	0,00037	0,828	0,00444
2160 317 02XX	BRON S/Ü IŞIKLI LIGHT (ÇAĞIRMA) (220V)	12	120	0,066	0,00037	0,792	0,00444
2160 326 02XX	BRON S/Ü IŞIKLI KOMÜTATÖR	12	120	0,07	0,00037	0,84	0,00444
2160 100 02XX	BRON S/Ü TOPRAKLI PRİZ	12	120	0,078	0,00037	0,936	0,00444
2160 101 02XX	BRON S/Ü TOPRAKSIZ PRİZ	12	120	0,065	0,00037	0,78	0,00444
2160 103 02XX	BRON S/Ü TOP.LI PRİZ PORSELEN	12	120	0,098	0,00037	1,176	0,00444
2160 104 02XX	BRON S/Ü TOP.SIZ PRİZ PORSELEN	12	120	0,086	0,00037	1,032	0,00444
2160 110 02XX	BRON S/Ü KAPAKLI TOP.LI PRİZ	10	100	0,1	0,00044	1	0,0044
2160 113 02XX	BRON S/Ü KAPAKLI TOP.LI PRİZ PORSELEN	10	100	0,107	0,00044	1,07	0,0044
2160 115 02XX	BRON S/Ü UPS (FRANSIZ) PRİZ	12	120	0,08	0,00044	0,96	0,00528
2160 125 02XX	BRON S/Ü TELEFON PRİZİ 1*RJ12	12	120	0,06	0,00037	0,72	0,00444
2160 136 02XX	BRON S/Ü DATA PRİZİ 1*RJ45 (CAT5)	12	120	0,06	0,00037	0,72	0,00444
2160 140 02XX	BRON S/Ü DATA PRİZİ 1*RJ45 (CAT6)	12	120	0,063	0,0004	0,756	0,0048
2160 166 02XX	BRON S/Ü SAT PRİZİ (GEÇİŞLİ) 4DB/F KONNEKTÖR	12	120	0,076	0,00037	0,912	0,00444
2160 167 02XX	BRON S/Ü SAT PRİZİ (SONLU)	12	120	0,074	0,00037	0,888	0,00444
2160 170 02XX	BRON S/Ü TV PRİZİ (GEÇİŞLİ)	12	120	0,07	0,00037	0,84	0,00444
2160 171 02XX	BRON S/Ü TV PRİZİ (SONLU)	12	120	0,071	0,00037	0,852	0,00444
2160 200 02XX	BRON S/Ü İKİLİ TOP.LI PRİZ PORSELEN	6	60	0,166	0,00073	0,996	0,00438
2160 201 02XX	BRON S/Ü İKİLİ TOPRAKSIZ PRİZ PORSELEN	8	80	0,142	0,00055	1,136	0,0044
2160 202 02XX	BRON S/Ü İKİLİ TOPRAKLI PRİZ	6	60	0,121	0,00073	0,726	0,00438
2160 203 02XX	BRON S/Ü İKİLİ TOPRAKSIZ PRİZ	8	80	0,098	0,00055	0,784	0,0044
2160 215 02XX	BRON S/Ü İKİLİ UPS (FRANSIZ) PRİZ	6	60	0,121	0,00073	0,726	0,00438

BRON AHŞAP ÜRÜN GRUBU WOOD PRODUCT GROUP

KOD CODE	ÜRÜN TANIMI DESCRIPTION	KUTU BOX	KOLİ PARCEL	BİRİM AĞIRLIK UNIT WEIGHT	BİRİM HACİM UNIT VOLUME	KUTU AĞIRLIK BOX WEIGHT	KUTU HACİM BOX VOLUME
2160 301 02XX	BRON S/Ü ANAHTAR	12	120	0,066	0,00037	0,792	0,00444
2160 302 02XX	BRON S/Ü KOMÜTATÖR	12	120	0,069	0,00037	0,828	0,00444
2160 303 02XX	BRON S/Ü VAVİEN	12	120	0,068	0,00037	0,816	0,00444
2160 307 02XX	BRON S/Ü LIGHT (ÇAĞIRMA)	12	120	0,066	0,00037	0,792	0,00444
2160 315 02XX	BRON S/Ü IŞIKLI ANAHTAR (220V)	12	120	0,067	0,00037	0,804	0,00444
2160 316 02XX	BRON S/Ü IŞIKLI VAVİEN (220V)	12	120	0,069	0,00037	0,828	0,00444
2160 317 02XX	BRON S/Ü IŞIKLI LIGHT (ÇAĞIRMA) (220V)	12	120	0,066	0,00037	0,792	0,00444
2160 326 02XX	BRON S/Ü IŞIKLI KOMÜTATÖR	12	120	0,07	0,00037	0,84	0,00444
2160 100 02XX	BRON S/Ü TOPRAKLI PRİZ	12	120	0,078	0,00037	0,936	0,00444
2160 101 02XX	BRON S/Ü TOPRAKSIZ PRİZ	12	120	0,065	0,00037	0,78	0,00444
2160 103 02XX	BRON S/Ü TOP.LI PRİZ PORSELEN	12	120	0,098	0,00037	1,176	0,00444
2160 104 02XX	BRON S/Ü TOP.SIZ PRİZ PORSELEN	12	120	0,086	0,00037	1,032	0,00444
2160 110 02XX	BRON S/Ü KAPAKLI TOP.LI PRİZ	10	100	0,1	0,00044	1	0,0044
2160 113 02XX	BRON S/Ü KAPAKLI TOP.LI PRİZ PORSELEN	10	100	0,107	0,00044	1,07	0,0044
2160 115 02XX	BRON S/Ü UPS (FRANSIZ) PRİZ	12	120	0,08	0,00044	0,96	0,00528
2160 125 02XX	BRON S/Ü TELEFON PRİZİ 1*RJ12	12	120	0,06	0,00037	0,72	0,00444
2160 136 02XX	BRON S/Ü DATA PRİZİ 1*RJ45 (CAT5)	12	120	0,06	0,00037	0,72	0,00444
2160 140 02XX	BRON S/Ü DATA PRİZİ 1*RJ45 (CAT6)	12	120	0,063	0,0004	0,756	0,0048
2160 166 02XX	BRON S/Ü SAT PRİZİ (GEÇİŞLİ) 4DB/F KONNEKTÖR	12	120	0,076	0,00037	0,912	0,00444
2160 167 02XX	BRON S/Ü SAT PRİZİ (SONLU)	12	120	0,074	0,00037	0,888	0,00444
2160 170 02XX	BRON S/Ü TV PRİZİ (GEÇİŞLİ)	12	120	0,07	0,00037	0,84	0,00444
2160 171 02XX	BRON S/Ü TV PRİZİ (SONLU)	12	120	0,071	0,00037	0,852	0,00444
2160 200 02XX	BRON S/Ü İKİLİ TOP.LI PRİZ PORSELEN	6	60	0,166	0,00073	0,996	0,00438
2160 201 02XX	BRON S/Ü İKİLİ TOPRAKSIZ PRİZ PORSELEN	8	80	0,142	0,00055	1,136	0,0044
2160 202 02XX	BRON S/Ü İKİLİ TOPRAKLI PRİZ	6	60	0,121	0,00073	0,726	0,00438
2160 203 02XX	BRON S/Ü İKİLİ TOPRAKSIZ PRİZ	8	80	0,098	0,00055	0,784	0,0044
2160 215 02XX	BRON S/Ü İKİLİ UPS (FRANSIZ) PRİZ	6	60	0,121	0,00073	0,726	0,00438



@mutlusanelectric



@mutlusanelk



@mutlusanelektrik



@mutlusanplastikelektrik



Mutlusan Grup Prizler, her kullanımda maksimum güvenliği garantileyerek, ev ve iş yerlerinizde huzurla kullanabileceğiniz bir çözüm sunar.

Mutlusan group sockets offer a solution that you can use peacefully in your home and workplace, ensuring maximum safety in every use.

Ri-tech
Olimpiä
Fiş Prizler



Güvenlik ve İşlevsellik Bir Arada

Mutlusan prizler, kullanıcıların güvenliğini ve kullanım kolaylığını ön planda tutarak tasarlanmıştır. Çocuk korumalı yapısı sayesinde, elektrik çarpmalarına karşı ekstra güvenlik sağlar, özellikle çocuklu evler için ideal bir çözümdür. Kolay bağlantı özelliği, montaj işlemini hızlı ve pratik hale getirir, böylece zaman ve iş gücü tasarrufu sağlar. Ayrıca, herhangi bir yüzeye sabitleme ve asabilme özelliği ile esnek montaj seçenekleri sunar, farklı yüzeylerde sorunsuz ve sağlam bir şekilde kullanılabilir. Mutlusan grup prizler, güvenlik, pratiklik ve estetik açıdan üstün performans sunarak, mekanlarınıza değer katar.

Security and Functionality Together

Mutlusan switches are designed by prioritizing users' security and ease of use. Thanks to its child-proof structure, it provides extra safety against electric shock and is an ideal solution especially for homes with children. Easy connection feature makes the assembly process fast and practical, thus saving time and labor. In addition, it offers flexible mounting options with the ability to fix and hang on any surface, and can be used smoothly and securely on different surfaces. Mutlusan switches add value to your spaces by offering superior performance in terms of security, practicality and aesthetics.

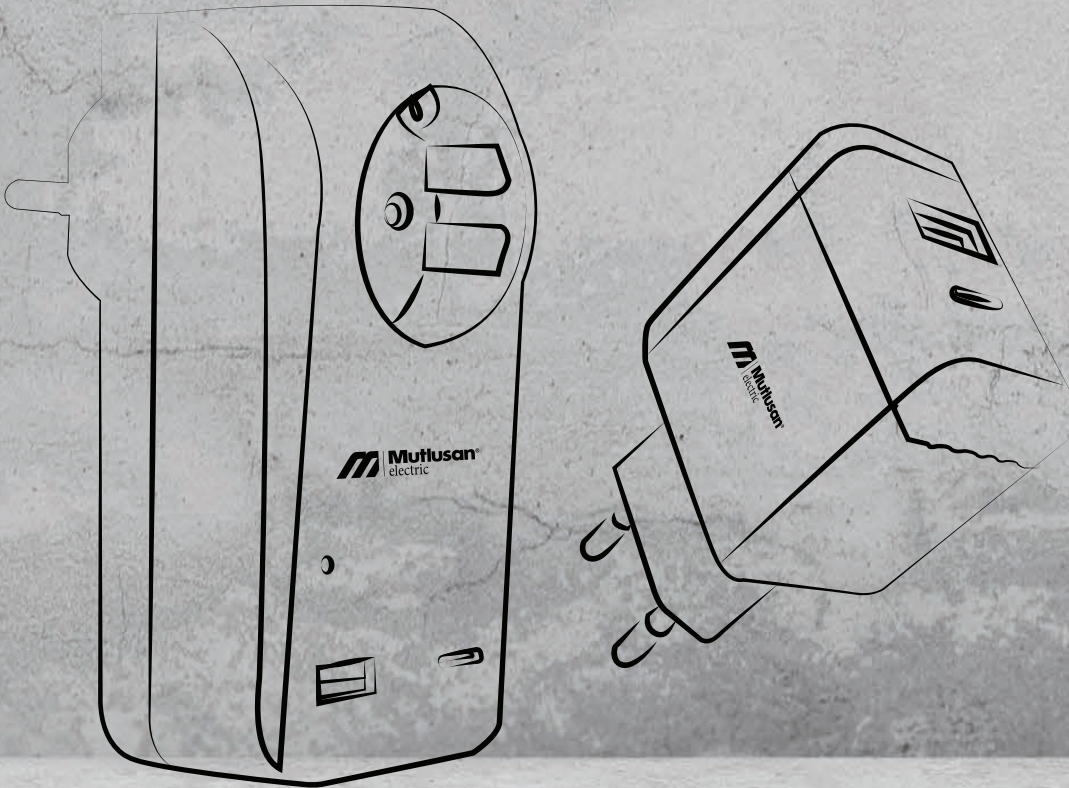

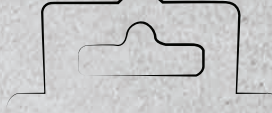

Askı Aparatı ile Pratik Montaj
Practical Mounting with Hanger



USB + Type - C Şarj Girişi ile Konfor
Comfort with USB + Type + C Charging Port



Çocuk Korumalı Güvenlik
Child Proof Security

Kolay Bağlantı ile Hızlı Montaj
Quick Assembly with
Easy Connection



Mavi Işık
Blue Light

**Cihazlarınız
KORUMA
Altında**
YOUR DEVICES ARE
UNDER PROTECTION



6x 
ÇOCUK KORUMALI
CHILD PROTECTION

2 YIL
YEAR
GARANTİ
GUARANTY

USB
12W
2.4A

1,5M 

1425
Joule





Ri-tech

Ri-tech Grup Prizler

Ri-tech Group Sockets



GRUP PRİZLER • GROUP SOCKETS

Kod Code	Ürün Tanımı Description	Kutu Ağırlık Box Weight (kg)	Hacim Volume (m³)	Kutu Box	
001 175 210001 00 00	İKİLİ TOP.LI GRUP PRİZ(Ç.K.)(KLEMENSLİ)	2 GANG EARTHED GROUP SOCKET(CHILD PROTEC.)(W/OUT CABLE)	2,60	0,01408	25
001 175 210002 01 00	İKİLİ TOP.LI GRUP PRİZ(Ç.K.)(1 MT)	2 GANG EARTHED GROUP SOCKET(CHILD PROTEC.)(1 MT)	3,73	0,01464	12
001 175 210002 02 00	İKİLİ TOP.LI GRUP PRİZ(Ç.K.)(2 MT)	2 GANG EARTHED GROUP SOCKET(CHILD PROTEC.)(2 MT)	3,73	0,01446	12
001 175 210002 03 00	İKİLİ TOP.LI GRUP PRİZ(Ç.K.)(3 MT)	2 GANG EARTHED GROUP SOCKET(CHILD PROTEC.)(3 MT)	4,68	0,01464	12
001 175 210002 05 00	İKİLİ TOP.LI GRUP PRİZ(Ç.K.)(5 MT)	2 GANG EARTHED GROUP SOCKET(CHILD PROTEC.)(5 MT)	6,61	0,01764	12
001 175 220001 00 00	İKİLİ ANAHT. TOP.LI GRUP PRİZ(Ç.K.)(KLEMENSLİ)	2 GANG EARTHED GROUP SOCKET(CHILD PROTEC.)(W/OUT CABLE+SWITCH)	3,28	0,01267	25
001 175 220002 01 00	İKİLİ ANAHT. TOP.LI GRUP PRİZ(Ç.K.)(1 MT)	2 GANG EARTHED GROUP SOCKET(CHILD PROTEC.)(WITH SWITCH)(1 MT)	3,73	0,01464	12
001 175 220002 02 00	İKİLİ ANAHT. TOP.LI GRUP PRİZ(Ç.K.)(2 MT)	2 GANG EARTHED GROUP SOCKET(CHILD PROTEC.)(WITH SWITCH)(2 MT)	3,73	0,01536	12
001 175 220002 03 00	İKİLİ ANAHT. TOP.LI GRUP PRİZ(Ç.K.)(3 MT)	2 GANG EARTHED GROUP SOCKET(CHILD PROTEC.)(WITH SWITCH)(3 MT)	4,68	0,01536	12
001 175 220002 05 00	İKİLİ ANAHT. TOP.LI GRUP PRİZ(Ç.K.)(5 MT)	2 GANG EARTHED GROUP SOCKET(CHILD PROTEC.)(WITH SWITCH)(5 MT)	6,61	0,01740	12
001 175 310001 00 00	ÜÇLÜ TOP.LI GRUP PRİZ(Ç.K.)(KLEMENSLİ)	3 GANG EARTHED GROUP SOCKET(CHILD PROTEC.)(W/OUT CABLE)	4,25	0,01310	25
001 175 310002 01 00	ÜÇLÜ TOP.LI GRUP PRİZ(Ç.K.)(1 MT)	3 GANG EARTHED GROUP SOCKET(CHILD PROTEC.)(1 MT)	3,06	0,01502	12
001 175 310002 02 00	ÜÇLÜ TOP.LI GRUP PRİZ(Ç.K.)(2 MT)	3 GANG EARTHED GROUP SOCKET(CHILD PROTEC.)(2 MT)	4,22	0,01595	12
001 175 310002 03 00	ÜÇLÜ TOP.LI GRUP PRİZ(Ç.K.)(3 MT)	3 GANG EARTHED GROUP SOCKET(CHILD PROTEC.)(3 MT)	5,00	0,01525	12
001 175 310002 05 00	ÜÇLÜ TOP.LI GRUP PRİZ(Ç.K.)(5 MT)	3 GANG EARTHED GROUP SOCKET(CHILD PROTEC.)(5 MT)	7,01	0,01764	12
001 175 320001 00 00	ÜÇLÜ ANAHT. TOP.LI GRUP PRİZ(Ç.K.)(KLEMENSLİ)	3 GANG EARTHED GROUP SOCKET(CHILD PROTEC.)(W/OUT CABLE+SWITCH)	4,00	0,01530	25
001 175 320002 01 00	ÜÇLÜ ANAHT. TOP.LI GRUP PRİZ(Ç.K.)(1 MT)	3 GANG EARTHED GROUP SOCKET(CHILD PROTEC.)(WITH SWITCH)(1 MT)	3,97	0,01560	12
001 175 320002 02 00	ÜÇLÜ ANAHT. TOP.LI GRUP PRİZ(Ç.K.)(2 MT)	3 GANG EARTHED GROUP SOCKET(CHILD PROTEC.)(WITH SWITCH)(2 MT)	4,38	0,01560	12
001 175 320002 03 00	ÜÇLÜ ANAHT. TOP.LI GRUP PRİZ(Ç.K.)(3 MT)	3 GANG EARTHED GROUP SOCKET(CHILD PROTEC.)(WITH SWITCH)(3 MT)	4,94	0,01764	12
001 175 320002 05 00	ÜÇLÜ ANAHT. TOP.LI GRUP PRİZ(Ç.K.)(5 MT)	3 GANG EARTHED GROUP SOCKET(CHILD PROTEC.)(WITH SWITCH)(5 MT)	6,82	0,01764	12
001 175 350001 00 00	ÜÇLÜ USB ANAHT. TOP.LI GRUP PRİZ(Ç.K.)(KLEMENSLİ)	3 GANG USB EARTHED GROUP SOCKET(CHILD PROTEC.)(W/OUT CABLE+SWITCH)	2,10	0,01942	25
001 175 350002 02 00	ÜÇLÜ USB ANAHT. TOP.LI GRUP PRİZ(Ç.K.)(2 MT)	3 GANG USB EARTHED GROUP SOCKET(CHILD PROTEC.)(WITH SWITCH)(2 MT)	5,00	0,00360	12
001 175 350002 03 00	ÜÇLÜ USB ANAHT. TOP.LI GRUP PRİZ(Ç.K.)(3 MT)	3 GANG USB EARTHED GROUP SOCKET(CHILD PROTEC.)(WITH SWITCH)(3 MT)	1,01	0,00360	12
001 175 350002 05 00	ÜÇLÜ USB ANAHT. TOP.LI GRUP PRİZ(Ç.K.)(5 MT)	3 GANG USB EARTHED GROUP SOCKET(CHILD PROTEC.)(WITH SWITCH)(5 MT)	1,01	0,00360	12
001 175 410001 00 00	DÖRTLÜ TOP.LI GRUP PRİZ(Ç.K.)(KLEMENSLİ)	4 GANG EARTHED GROUP SOCKET(CHILD PROTEC.)(W/OUT CABLE)	4,05	0,02500	25
001 175 410002 01 00	DÖRTLÜ TOP.LI GRUP PRİZ(Ç.K.)(1 MT)	4 GANG EARTHED GROUP SOCKET(CHILD PROTEC.)(1 MT)	4,28	0,01680	12
001 175 410002 02 00	DÖRTLÜ TOP.LI GRUP PRİZ(Ç.K.)(2 MT)	4 GANG EARTHED GROUP SOCKET(CHILD PROTEC.)(2 MT)	4,28	0,01827	12
001 175 410002 03 00	DÖRTLÜ TOP.LI GRUP PRİZ(Ç.K.)(3 MT)	4 GANG EARTHED GROUP SOCKET(CHILD PROTEC.)(3 MT)	5,40	0,01680	12
001 175 410002 05 00	DÖRTLÜ TOP.LI GRUP PRİZ(Ç.K.)(5 MT)	4 GANG EARTHED GROUP SOCKET(CHILD PROTEC.)(5 MT)	7,40	0,01764	12
001 175 420001 00 00	DÖRTLÜ ANAHT. TOP.LI GRUP PRİZ(Ç.K.)(KLEMENSLİ)	4 GANG EARTHED GROUP SOCKET(CHILD PROTEC.)(W/OUT CABLE+SWITCH)	3,75	0,02099	25
001 175 420002 01 00	DÖRTLÜ ANAHT. TOP.LI GRUP PRİZ(Ç.K.)(1 MT)	4 GANG EARTHED GROUP SOCKET(CHILD PROTEC.)(WITH SWITCH)(1 MT)	4,28	0,01680	12
001 175 420002 02 00	DÖRTLÜ ANAHT. TOP.LI GRUP PRİZ(Ç.K.)(2 MT)	4 GANG EARTHED GROUP SOCKET(CHILD PROTEC.)(WITH SWITCH)(2 MT)	4,28	0,01680	12
001 175 420002 03 00	DÖRTLÜ ANAHT. TOP.LI GRUP PRİZ(Ç.K.)(3 MT)	4 GANG EARTHED GROUP SOCKET(CHILD PROTEC.)(WITH SWITCH)(3 MT)	5,40	0,01992	12
001 175 420002 05 00	DÖRTLÜ ANAHT. TOP.LI GRUP PRİZ(Ç.K.)(5 MT)	4 GANG EARTHED GROUP SOCKET(CHILD PROTEC.)(WITH SWITCH)(5 MT)	7,40	0,02015	12
001 175 610001 00 00	ALTILI TOP.LI GRUP PRİZ(Ç.K.)(KLEMENSLİ)	6 GANG EARTHED GROUP SOCKET(CHILD PROTEC.)(W/OUT CABLE)	5,50	0,02389	25
001 175 610002 01 00	ALTILI TOP.LI GRUP PRİZ(Ç.K.)(1 MT)	6 GANG EARTHED GROUP SOCKET(CHILD PROTEC.)(1 MT)	4,46	0,02541	12
001 175 610002 02 00	ALTILI TOP.LI GRUP PRİZ(Ç.K.)(2 MT)	6 GANG EARTHED GROUP SOCKET(CHILD PROTEC.)(2 MT)	6,10	0,02541	12
001 175 610002 03 00	ALTILI TOP.LI GRUP PRİZ(Ç.K.)(3 MT)	6 GANG EARTHED GROUP SOCKET(CHILD PROTEC.)(3 MT)	7,42	0,02541	12
001 175 610002 05 00	ALTILI TOP.LI GRUP PRİZ(Ç.K.)(5 MT)	6 GANG EARTHED GROUP SOCKET(CHILD PROTEC.)(5 MT)	9,94	0,02867	12
001 175 620001 00 00	ALTILI ANAHT. TOP.LI GRUP PRİZ(Ç.K.)(KLEMENSLİ)	6 GANG EARTHED GROUP SOCKET(CHILD PROTEC.)(W/OUT CABLE+SWITCH)	6,63	0,02723	25
001 175 620002 01 00	ALTILI ANAHT. TOP.LI GRUP PRİZ(Ç.K.)(1 MT)	6 GANG EARTHED GROUP SOCKET(CHILD PROTEC.)(WITH SWITCH)(1 MT)	4,76	0,02747	12
001 175 620002 02 00	ALTILI ANAHT. TOP.LI GRUP PRİZ(Ç.K.)(2 MT)	6 GANG EARTHED GROUP SOCKET(CHILD PROTEC.)(WITH SWITCH)(2 MT)	6,40	0,03466	12
001 175 620002 03 00	ALTILI ANAHT. TOP.LI GRUP PRİZ(Ç.K.)(3 MT)	6 GANG EARTHED GROUP SOCKET(CHILD PROTEC.)(WITH SWITCH)(3 MT)	7,72	0,02747	12
001 175 620002 05 00	ALTILI ANAHT. TOP.LI GRUP PRİZ(Ç.K.)(5 MT)	6 GANG EARTHED GROUP SOCKET(CHILD PROTEC.)(WITH SWITCH)(5 MT)	10,25	0,02867	12
001 175 650001 00 00	ALTILI USB ANAHT. TOP.LI GRUP PRİZ(Ç.K.)(KLEMENSLİ)	6 GANG USB EARTHED GROUP SOCKET(CHILD PROTEC.)(W/OUT CABLE+SWITCH)	8,34	0,02966	25
001 175 650002 02 00	ALTILI USB ANAHT. TOP.LI GRUP PRİZ(Ç.K.)(2 MT)	6 GANG USB EARTHED GROUP SOCKET(CHILD PROTEC.)(WITH SWITCH)(2 MT)	1,01	0,00360	12
001 175 650002 03 00	ALTILI USB ANAHT. TOP.LI GRUP PRİZ(Ç.K.)(3 MT)	6 GANG USB EARTHED GROUP SOCKET(CHILD PROTEC.)(WITH SWITCH)(3 MT)	1,01	0,00360	12
001 175 650002 05 00	ALTILI USB ANAHT. TOP.LI GRUP PRİZ(Ç.K.)(5 MT)	6 GANG USB EARTHED GROUP SOCKET(CHILD PROTEC.)(WITH SWITCH)(5 MT)	1,01	0,00360	12
001 175 330001 00 00	ÜÇLÜ UPS GRUP PRİZ(Ç.K.)(KLEMENSLİ)	3 GANG UPS GROUP SOCKET(CHILD PROTEC.)(W/OUT CABLE)	2,83	0,01475	25
001 175 330002 02 00	ÜÇLÜ UPS GRUP PRİZ(Ç.K.)(2 MT)	3 GANG UPS GROUP SOCKET(CHILD PROTEC.)(2 MT)	3,73	0,01560	12
001 175 330002 03 00	ÜÇLÜ UPS GRUP PRİZ(Ç.K.)(3 MT)	3 GANG UPS GROUP SOCKET(CHILD PROTEC.)(3 MT)	4,68	0,01536	12
001 175 330002 05 00	ÜÇLÜ UPS GRUP PRİZ(Ç.K.)(5 MT)	3 GANG UPS GROUP SOCKET(CHILD PROTEC.)(5 MT)	6,61	0,01740	12

GRUP PRİZLER • GROUP SOCKETS

Kod Code	Ürün Tanımı Description		Kutu Ağırlık Box Weight (kg)	Hacim Volume (m³)	Kutu Box
001 175 340001 00 00	ÜÇLÜ ANAHT. UPS GRUP PRİZ(Ç.K.)(KLEMENSLİ)	3 GANG UPS GROUP SOCKET(CHILD PROTEC.)(W/OUT CABLE+SWITCH)	2,93	0,01500	25
001 175 340002 02 00	ÜÇLÜ ANAHT. UPS GRUP PRİZ(Ç.K.)(2 MT)	3 GANG UPS GROUP SOCKET(CHILD PROTEC.)(WITH SWITCH)(2 MT)	3,73	0,01560	12
001 175 340002 03 00	ÜÇLÜ ANAHT. UPS GRUP PRİZ(Ç.K.)(3 MT)	3 GANG UPS GROUP SOCKET(CHILD PROTEC.)(WITH SWITCH)(3 MT)	4,68	0,01536	12
001 175 340002 05 00	ÜÇLÜ ANAHT. UPS GRUP PRİZ(Ç.K.)(5 MT)	3 GANG UPS GROUP SOCKET(CHILD PROTEC.)(WITH SWITCH)(5 MT)	6,61	0,01740	12
001 175 430001 00 00	DÖRTLÜ UPS GRUP PRİZ(Ç.K.)(KLEMENSLİ)	4 GANG UPS GROUP SOCKET(CHILD PROTEC.)(W/OUT CABLE)	3,75	0,02500	25
001 175 430002 02 00	DÖRTLÜ UPS GRUP PRİZ(Ç.K.)(2 MT)	4 GANG UPS GROUP SOCKET(CHILD PROTEC.)(2 MT)	4,28	0,01680	12
001 175 430002 03 00	DÖRTLÜ UPS GRUP PRİZ(Ç.K.)(3 MT)	4 GANG UPS GROUP SOCKET(CHILD PROTEC.)(3 MT)	5,40	0,01680	12
001 175 430002 05 00	DÖRTLÜ UPS GRUP PRİZ(Ç.K.)(5 MT)	4 GANG UPS GROUP SOCKET(CHILD PROTEC.)(5 MT)	7,40	0,01800	12
001 175 440001 00 00	DÖRTLÜ ANAHT. UPS GRUP PRİZ(Ç.K.)(KLEMENSLİ)	4 GANG UPS GROUP SOCKET(CHILD PROTEC.)(W/OUT CABLE+ SWITCH)	2,10	0,00750	25
001 175 440002 02 00	DÖRTLÜ ANAHT. UPS GRUP PRİZ(Ç.K.)(2 MT)	4 GANG UPS GROUP SOCKET(CHILD PROTEC.)(WITH SWITCH)(2 MT)	1,01	0,00360	12
001 175 440002 03 00	DÖRTLÜ ANAHT. UPS GRUP PRİZ(Ç.K.)(3 MT)	4 GANG UPS GROUP SOCKET(CHILD PROTEC.)(WITH SWITCH)(3 MT)	1,01	0,00360	12
001 175 440002 05 00	DÖRTLÜ ANAHT. UPS GRUP PRİZ(Ç.K.)(5 MT)	4 GANG UPS GROUP SOCKET(CHILD PROTEC.)(WITH SWITCH)(5 MT)	1,01	0,00360	12
001 175 630001 00 00	ALTILI UPS GRUP PRİZ(Ç.K.)(KLEMENSLİ)	6 GANG UPS GROUP SOCKET(CHILD PROTEC.)(W/OUT CABLE)	2,10	0,00750	25
001 175 630002 02 00	ALTILI UPS GRUP PRİZ(Ç.K.)(2 MT)	6 GANG UPS GROUP SOCKET(CHILD PROTEC.)(2 MT)	1,01	0,00360	12
001 175 630002 03 00	ALTILI UPS GRUP PRİZ(Ç.K.)(3 MT)	6 GANG UPS GROUP SOCKET(CHILD PROTEC.)(3 MT)	1,01	0,00360	12
001 175 630002 05 00	ALTILI UPS GRUP PRİZ(Ç.K.)(5 MT)	6 GANG UPS GROUP SOCKET(CHILD PROTEC.)(5 MT)	1,01	0,00360	12
001 175 640001 00 00	ALTILI ANAHT. UPS GRUP PRİZ(Ç.K.)(KLEMENSLİ)	6 GANG UPS GROUP SOCKET(CHILD PROTEC.)(W/OUT CABLE+ SWITCH)	2,10	0,00750	25
001 175 640002 02 00	ALTILI ANAHT. UPS GRUP PRİZ(Ç.K.)(2 MT)	6 GANG UPS GROUP SOCKET(CHILD PROTEC.)(WITH SWITCH)(2 MT)	6,94	0,02747	12
001 175 640002 03 00	ALTILI ANAHT. UPS GRUP PRİZ(Ç.K.)(3 MT)	6 GANG UPS GROUP SOCKET(CHILD PROTEC.)(WITH SWITCH)(3 MT)	8,30	0,02736	12
001 175 640002 05 00	ALTILI ANAHT. UPS GRUP PRİZ(Ç.K.)(5 MT)	6 GANG UPS GROUP SOCKET(CHILD PROTEC.)(WITH SWITCH)(5 MT)	11,12	0,02866	12
001 175 390001 00 00	ÜÇLÜ TOPRAKSIZ GRUP PRİZ(Ç.K.)(KLEMENSLİ)	3 GANG NON EARTHED GROUP SOCKET(W/OUT CABLE)	4,25	0,01310	25
001 175 390002 02 00	ÜÇLÜ TOPRAKSIZ GRUP PRİZ(Ç.K.)(2 MT)	3 GANG NON EARTHED GROUP SOCKET OUTLET (2 MT) CABLE	4,90	0,01595	12
001 175 390002 03 00	ÜÇLÜ TOPRAKSIZ GRUP PRİZ(Ç.K.)(3 MT)	3 GANG NON EARTHED GROUP SOCKET OUTLET (3 MT) CABLE	5,16	0,01595	12
001 175 390002 05 00	ÜÇLÜ TOPRAKSIZ GRUP PRİZ(Ç.K.)(5 MT)	3 GANG NON EARTHED GROUP SOCKET OUTLET (5 MT) CABLE	5,76	0,01827	12
001 175 390002 07 00	ÜÇLÜ TOPRAKSIZ GRUP PRİZ(Ç.K.)(7 MT)	3 GANG NON EARTHED GROUP SOCKET OUTLET (7 MT) CABLE	6,60	0,01698	12
001 175 390002 10 00	ÜÇLÜ TOPRAKSIZ GRUP PRİZ(Ç.K.)(10 MT)	3 GANG NON EARTHED GROUP SOCKET OUTLET (10 MT) CABLE	8,28	0,02618	12
001 175 392001 00 00	ÜÇLÜ ANAHT. TOP.SIZ GRUP PRİZ(Ç.K.)(KLEMENSLİ)	3 GANG NON EARTHED GROUP SOCKET(W/OUT CABLE)(WITH SWITCH)	10,30	0,03250	25
001 175 392002 02 00	ÜÇLÜ ANAHT. TOP.SIZ GRUP PRİZ(Ç.K.)(2 MT)	3 GANG NON EARTHED GROUP SOCKET OUTLET 2 MT CORD (WITH SWITCH)	4,94	0,01560	12
001 175 392002 03 00	ÜÇLÜ ANAHT. TOP.SIZ GRUP PRİZ(Ç.K.)(3 MT)	3 GANG NON EARTHED GROUP SOCKET OUTLET 3 MT CORD (WITH SWITCH)	4,94	0,01764	12
001 175 392002 05 00	ÜÇLÜ ANAHT. TOP.SIZ GRUP PRİZ(Ç.K.)(5 MT)	3 GANG NON EARTHED GROUP SOCKET OUTLET 5 MT CORD (WITH SWITCH)	4,94	0,01764	12
001 175 490001 00 00	DÖRTLÜ TOP.SIZ GRUP PRİZ(Ç.K.)(KLEMENSLİ)	4 GANG NON EARTHED GROUP SOCKET(W/OUT CABLE)	3,95	0,01886	25
001 175 490002 02 00	DÖRTLÜ TOP.SIZ GRUP PRİZ(Ç.K.)(2 MT)	4 GANG NON EARTHED GROUP SOCKET OUTLET 2 MT CORD	3,60	0,01827	12
001 175 490002 03 00	DÖRTLÜ TOP.SIZ GRUP PRİZ(Ç.K.)(3 MT)	4 GANG NON EARTHED GROUP SOCKET OUTLET 3 MT CORD	4,38	0,01827	12
001 175 490002 05 00	DÖRTLÜ TOP.SIZ GRUP PRİZ(Ç.K.)(5 MT)	4 GANG NON EARTHED GROUP SOCKET OUTLET 5 MT CORD	6,36	0,01764	12
001 175 492001 00 00	DÖRTLÜ ANAHT. TOP.SIZ GRUP PRİZ(Ç.K.)(KLEMENSLİ)	4 GANG NON EARTHED GROUP SOCKET(W/OUT CABLE)(WITH SWITCH)	10,30	0,03250	25
001 175 492002 02 00	DÖRTLÜ ANAHT. TOP.SIZ GRUP PRİZ(Ç.K.)(2 MT)	4 GANG NON EARTHED GROUP SOCKET OUTLET (2 MT) CABLE (WITH SWITCH)	4,94	0,01560	12
001 175 492002 03 00	DÖRTLÜ ANAHT. TOP.SIZ GRUP PRİZ(Ç.K.)(3 MT)	4 GANG NON EARTHED GROUP SOCKET OUTLET (3MT) CABLE (WITH SWITCH)	4,94	0,01560	12
001 175 492002 05 00	DÖRTLÜ ANAHT. TOP.SIZ GRUP PRİZ(Ç.K.)(5 MT)	4 GANG NON EARTHED GROUP SOCKET OUTLET (5 MT) CABLE (WITH SWITCH)	4,94	0,01560	12
001 175 690001 00 00	ALTILI TOP.SIZ GRUP PRİZ(Ç.K.)(KLEMENSLİ)	6 GANG NON EARTHED GROUP SOCKET(W/OUT CABLE)	10,30	0,02389	25
001 175 690002 02 00	ALTILI TOP.SIZ GRUP PRİZ(Ç.K.)(2 MT)	6 GANG NON EARTHED GROUP SOCKET OUTLET (2 MT) CABLE	4,94	0,01560	12
001 175 690002 03 00	ALTILI TOP.SIZ GRUP PRİZ(Ç.K.)(3 MT)	6 GANG NON EARTHED GROUP SOCKET OUTLET (3 MT) CABLE	4,94	0,01560	12
001 175 690002 05 00	ALTILI TOP.SIZ GRUP PRİZ(Ç.K.)(5 MT)	6 GANG NON EARTHED GROUP SOCKET OUTLET (5 MT) CABLE	4,94	0,01560	12
001 175 692001 00 00	ALTILI ANAHT. TOP.SIZ GRUP PRİZ(Ç.K.)(KLEMENSLİ)	6 GANG NON EARTHED GROUP SOCKET(W/OUT CABLE)(WITH SWITCH)	10,30	0,03250	25
001 175 692002 02 00	ALTILI ANAHT. TOP.SIZ GRUP PRİZ(Ç.K.)(2 MT)	6 GANG NON EARTHED GROUP SOCKET OUTLET (2 MT) CABLE (WITH SWITCH)	4,94	0,01560	12
001 175 692002 03 00	ALTILI ANAHT. TOP.SIZ GRUP PRİZ(Ç.K.)(3 MT)	6 GANG NON EARTHED GROUP SOCKET OUTLET (3 MT) CABLE (WITH SWITCH)	4,94	0,01560	12
001 175 692002 05 00	ALTILI ANAHT. TOP.SIZ GRUP PRİZ(Ç.K.)(5 MT)	6 GANG NON EARTHED GROUP SOCKET OUTLET (5 MT) CABLE (WITH SWITCH)	4,94	0,01560	12
001 175 350101 00 00	ÜÇLÜ USB+TYPE-C ANAHT. TOP.LI GRUP PRİZ(Ç.K.)(KLEMENSLİ)	3 GANG USB +TYPE-C EARTHED GROUP SOCKET(CHILD PROT.)W/OUT CABLE (WITH SWITCH)	2,10	0,00750	25
001 175 350102 01 00	ÜÇLÜ USB+TYPE-C ANAHT. TOP.LI GRUP PRİZ(Ç.K.)(1 MT)	3 GANG USB +TYPE-C EARTHED GROUP SOCKET(CHILD PROT.) (1 MT) CABLE (WITH SWITCH)	5,00	0,00360	12
001 175 350102 02 00	ÜÇLÜ USB+TYPE-C ANAHT. TOP.LI GRUP PRİZ(Ç.K.)(2 MT)	3 GANG USB +TYPE-C EARTHED GROUP SOCKET(CHILD PROT.) (2MT) CABLE (WITH SWITCH)	5,00	0,00360	12
001 175 350102 03 00	ÜÇLÜ USB+TYPE-C ANAHT. TOP.LI GRUP PRİZ(Ç.K.)(3 MT)	3 GANG USB +TYPE-C EARTHED GROUP SOCKET(CHILD PROT.) (3MT) CABLE (WITH SWITCH)	1,01	0,00360	12
001 175 350102 05 00	ÜÇLÜ USB+TYPE-C ANAHT. TOP.LI GRUP PRİZ(Ç.K.)(5 MT)	3 GANG USB +TYPE-C EARTHED GROUP SOCKET(CHILD PROT.) (5 MT) CABLE (WITH SWITCH)	1,01	0,00360	12
001 175 650101 00 00	ALTILI USB+TYPE-C ANAHT. TOP.LI GRUP PRİZ(Ç.K.)(KLEMENSLİ)	6 GANG EARTHED GROUP SOCKET WITH USB+TYPE-C (WITH SWITCH AND CHILD PROTECTION (W/OUT CABLE)	2,10	0,00750	25
001 175 650102 01 00	ALTILI USB+TYPE-C ANAHT. TOP.LI GRUP PRİZ(Ç.K.)(1 MT)	6 GANG EARTHED GROUP SOCKET WITH USB+TYPE-C (WITH SWITCH AND CHILD PROTECTION (1 MT CABLE)	1,01	0,00360	12
001 175 650102 02 00	ALTILI USB+TYPE-C ANAHT. TOP.LI GRUP PRİZ(Ç.K.)(2 MT)	6 GANG EARTHED GROUP SOCKET WITH USB+TYPE-C (WITH SWITCH AND CHILD PROTECTION (2 MT CABLE)	1,01	0,00360	12
001 175 650102 03 00	ALTILI USB+TYPE-C ANAHT. TOP.LI GRUP PRİZ(Ç.K.)(3 MT)	6 GANG EARTHED GROUP SOCKET WITH USB+TYPE-C (WITH SWITCH AND CHILD PROTECTION (3 MT CABLE)	1,01	0,00360	12
001 175 650102 05 00	ALTILI USB+TYPE-C ANAHT. TOP.LI GRUP PRİZ(Ç.K.)(5 MT)	6 GANG EARTHED GROUP SOCKET WITH USB+TYPE-C (WITH SWITCH AND CHILD PROTECTION (5 MT CABLE)	1,01	0,00360	12



GRUP PRİZLER • GROUP SOCKETS

Kod Code	Ürün Tanımı Description		Kutu Ağırlık Box Weight (kg)	Hacim Volume (m³)	Kutu Box
001 171 290001 00 00	İKİLİ TOPRAKSIZ GRUP PRİZ(KLEMENSLİ)	2 GANG NON EARTHED GROUP SOCKET OUTLET CORDLESS	1,90	0,00792	25
001 171 290002 02 00	İKİLİ TOPRAKSIZ GRUP PRİZ(2MT)	2 GANG NON EARTHED GROUP SOCKET (2 mt)	2,64	0,01272	12
001 171 290002 03 00	İKİLİ TOPRAKSIZ GRUP PRİZ(3MT)	2 GANG NON EARTHED GROUP SOCKET (3 mt)	3,48	0,01446	12
001 171 290002 05 00	İKİLİ TOPRAKSIZ GRUP PRİZ(5MT)	2 GANG NON EARTHED GROUP SOCKET (5 mt)	4,94	0,01173	12
001 171 210001 00 00	İKİLİ TOPRAKLI GRUP PRİZ(KLEMENSLİ)	2 GANG EARTHED SOCKET (WITH TERMINAL)	2,15	0,00869	25
001 171 210002 02 00	İKİLİ TOPRAKLI GRUP PRİZ(2MT)	2 GANG EARTHED SOCKET OUTLET (2 mt cord)	3,42	0,01416	12
001 171 210002 03 00	İKİLİ TOPRAKLI GRUP PRİZ(3MT)	2 GANG EARTHED SOCKET OUTLET (3 mt cord)	4,51	0,01416	12
001 171 210002 05 00	İKİLİ TOPRAKLI GRUP PRİZ(5MT)	2 GANG EARTHED SOCKET OUTLET (5 mt cord)	6,39	0,01608	12
001 171 390001 00 00	ÜÇLÜ TOPRAKSIZ GRUP PRİZ(KLEMENSLİ)	3 GANG NON EARTHED GROUP SOCKET (WITH TERMINAL)	2,40	0,01017	25
001 171 390002 02 00	ÜÇLÜ TOPRAKSIZ GRUP PRİZ(2MT)	3 GANG NON EARTHED GROUP SOCKET OUTLET (2 mt cord)	2,88	0,01173	12
001 171 390002 03 00	ÜÇLÜ TOPRAKSIZ GRUP PRİZ(3MT)	3 GANG NON EARTHED GROUP SOCKET OUTLET (3 mt cord)	3,70	0,01173	12
001 171 390002 05 00	ÜÇLÜ TOPRAKSIZ GRUP PRİZ(5MT)	3 GANG NON EARTHED GROUP SOCKET OUTLET (5 mt cord)	5,27	0,01764	12
001 171 310001 00 00	ÜÇLÜ GRUP PRİZ TOPRAKLI(KLEMENSLİ)	3 GANG EARTHED SOCKET (WITH TERMINAL)	2,88	0,01250	25
001 171 310002 02 00	ÜÇLÜ TOPRAKLI GRUP PRİZ(2MT)	3 GANG EARTHED SOCKET (2 mt)	3,75	0,01416	12
001 171 310002 03 00	ÜÇLÜ TOPRAKLI GRUP PRİZ(3MT)	3 GANG EARTHED SOCKET (3 mt)	4,85	0,01416	12
001 171 310002 05 00	ÜÇLÜ TOPRAKLI GRUP PRİZ(5MT)	3 GANG EARTHED SOCKET (5 mt)	6,70	0,01608	12
001 171 320001 00 00	ÜÇLÜ TOPRAKLI GRUP PRİZ(KLEMENSLİ ANAHTARLI)	3 GANG EARTHED SOCKET (WITH TERMINAL AND SWITCH)	3,63	0,01433	25
001 171 320001 02 00	ÜÇLÜ TOPRAKLI GRUP PRİZ(ANAHTARLI 2MT)	3 GANG EARTHED SOCKET (WITH SWITCH 2 mt)	4,10	0,01416	12
001 171 320002 03 00	ÜÇLÜ TOPRAKSIZ GRUP PRİZ(ANAHTARLI 3MT)	3 GANG EARTHED SOCKET (WITH SWITCH 3 mt)	5,08	0,01380	12
001 171 320002 05 00	DÖRTLÜ TOPRAKSIZ GRUP PRİZ(ANAHTARLI 5MT)	3 GANG EARTHED SOCKET (WITH SWITCH 5 mt)	6,98	0,01692	12
001 171 340001 00 00	ÜÇLÜ UPS GRUP PRİZ(KLEMENSLİ)	EARTHED 3 GANG UPS SOCKET (WITH TERMINAL)	3,01	0,01500	25
001 171 330001 02 00	ÜÇLÜ UPS GRUP PRİZ(2MT)	3 GANG UPS GROUP SOCKET (2 mt)	3,56	0,01416	12
001 171 330001 03 00	ÜÇLÜ UPS GRUP PRİZ(3MT)	3 GANG UPS GROUP SOCKET (3 mt)	4,73	0,01416	12
001 171 330001 05 00	ÜÇLÜ UPS GRUP PRİZ(5MT)	3 GANG UPS GROUP SOCKET (5 mt)	6,70	0,01608	12
001 171 410001 00 00	DÖRTLÜ TOPRAKLI GRUP PRİZ(KLEMENSLİ)	4 GANG EARTHED SOCKET (WITH TERMINAL)	3,90	0,01470	25
001 171 410001 02 00	DÖRTLÜ TOPRAKLI GRUP PRİZ(2MT)	4 GANG EARTHED SOCKET (2 mt)	4,43	0,01788	12
001 171 410001 03 00	DÖRTLÜ TOPRAKLI GRUP PRİZ(3MT)	4 GANG EARTHED SOCKET (3 mt)	5,53	0,01788	12
001 171 410001 05 00	DÖRTLÜ TOPRAKLI GRUP PRİZ(5MT)	4 GANG EARTHED SOCKET (5 mt)	7,35	0,01896	12
001 171 410002 00 00	DÖRTLÜ TOPRAKLI GRUP PRİZ(KLEMENSLİ ANAHTARLI)	4 GANG EARTHED SOCKET (WITH TERMINAL AND SWITCH)	4,33	0,01764	25
001 171 410002 02 00	DÖRTLÜ TOPRAKLI GRUP PRİZ(ANAHTARLI 2MT)	4 GANG EARTHED SOCKET (WITH SWITCH 2 mt)	4,43	0,01788	12
001 171 410002 03 00	DÖRTLÜ TOPRAKLI GRUP PRİZ(ANAHTARLI 3MT)	4 GANG EARTHED SOCKET (WITH SWITCH 3 mt)	5,53	0,01788	12
001 171 410002 05 00	DÖRTLÜ TOPRAKLI GRUP PRİZ(ANAHTARLI 5MT)	4 GANG EARTHED SOCKET (WITH SWITCH 5 mt)	7,35	0,01896	12
001 171 610001 00 00	ALTI TOPRAKLI GRUP PRİZ(KLEMENSLİ)	6 GANG EARTHED SOCKET (WITH TERMINAL)	5,18	0,02389	25
001 171 610001 02 00	ALTI TOPRAKLI GRUP PRİZ(2MT)	6 GANG EARTHED SOCKET (2 mt)	5,51	0,02352	12
001 171 610001 03 00	ALTI TOPRAKLI GRUP PRİZ(3MT)	6 GANG EARTHED SOCKET (3 mt)	6,86	0,02424	12
001 171 610001 05 00	ALTI TOPRAKLI GRUP PRİZ(5MT)	6 GANG EARTHED SOCKET (5 mt)	9,38	0,02618	12
001 171 610002 00 00	ALTI TOPRAKLI GRUP PRİZ(KLEMENSLİ ANAHTARLI)	6 GANG EARTHED SOCKET (WITH TERMINAL AND SWITCH)	5,53	0,02389	25
001 171 610002 02 00	ALTI TOPRAKLI GRUP PRİZ(ANAHTARLI 2MT)	6 GANG EARTHED SOCKET (WITH SWITCH 2 mt)	5,25	0,02424	12
001 171 610002 03 00	ALTI TOPRAKLI GRUP PRİZ(ANAHTARLI 3MT)	6 GANG EARTHED SOCKET (WITH SWITCH 3 mt)	7,16	0,02541	12
001 171 610002 05 00	ALTI TOPRAKLI GRUP PRİZ(ANAHTARLI 5MT)	6 GANG EARTHED SOCKET (WITH SWITCH 5 mt)	9,61	0,02568	12
001 170 110001 00 00	10'lu TOPRAKLI GRUP PRİZ (KLEMENSLİ)	10 GANG EARTHED SOCKET (W/OUT CABLE)	7,20	0,0261555	20



**“Elektronik cihazlarını güvenle şarj et,
ders çalışırken kesinti yaşama.”**

“Charge your electronic devices safely and avoid interruptions while studying.”

ŞOK KORUMALI PRİZLER • SURGE PROTECTION SOCKET

Kod Code	Ürün Tanımı Description	Kutu Ağırlık Box Weight (kg)	Hacim Volume (m ³)	Kutu Box
001 175 660002 15 00	ALTILI ŞOK KOR.USB ANHT. TOP.LI GRUP PRİZ (Ç.K.)(3x1.5/1.5 MT)(1425 J) 6 GANG EARTHED GROUP SOCKET WITH SURGE PROTEC. 2XUSB CHARGER WITH SWITCH AND CHILD PROTEC. WITH 1,5 MT CORD (1425 J)	6,85	0,04275	12
001 175 660102 15 00	ALTILI ŞOK KOR.USB + TYPE-C ANHT. TOP.LI GRUP PRİZ (Ç.K.) (3x1.5/1.5 MT)(1425 J) 6 GANG EARTHED GROUP SOCKET WITH SURGE PROTEC. USB+TYPE-C CHARGER WITH SWITCH AND CHILD PROTEC. WITH 1,5 MT CORD (1425 J)	6,85	0,04275	12
001 175 670002 15 00	ALTILI ŞOK KOR. ANAHT. TOP.LI GRUP PRİZ (Ç.K.) (3x1.5 1.5 MT) (1425 J) 6 GANG EARTHED GROUP SOCKET WITH SURGE PROTEC.WITH SWITCH AND CHILD PROTEC. WITH 1,5 MT CORD (1425 J)	6,65	0,04275	12
001 175 370002 15 00	ÜÇLÜ ŞOK KOR. ANAHT. TOP.LI GRUP PRİZ (Ç.K.)(3x1.5 1.5 MT) (525 J) 3 GANG EARTHED GROUP SOCKET WITH SURGE PROTEC. WITH SWITCH AND CHILD PROTEC. 1,5 MT CORD (525 J)	5,00	0,00360	12
001 175 370002 03 00	ÜÇLÜ ŞOK KOR. ANAHT. TOP.LI GRUP PRİZ (Ç.K.)(3x1.5 3 MT) (525 J) 3 GANG EARTHED GROUP SOCKET WITH SURGE PROTEC. WITH SWITCH AND CHILD PROTEC. 1,5 MT CORD (525 J)	5,00	0,00360	12
001 888 100002 00 00	2'LI USB ŞARJ ADAPTÖR 2,4A DOUBLE USB CHARGER ADAPTER 2.4A	1,24	0,00820	20
001 888 100003 00 00	USB + TYPE-C ŞARJ ADAPTÖRÜ 2,4A USB CHARGER +TYPE -C ADAPTER	1,24	0,00820	20
001 888 100004 00 00	TEKLİ ŞOK KORUMALI PRİZ (625 J) SINGLE SURGE PROTECTION SOCKET (625 J)	1,56	0,00774	12
001 888 100006 00 00	TEKLİ ŞOK KORUMALI USB + TYPE-C PRİZ (625 J) SINGLE SURGE PROTECTION +USB CHARGER (625 J)	1,56	0,00774	12

Fiş Prizler



Erkek Fiş
Male Socket

001 170 010001 00 00



Topraklı Erkek Fiş
Earthed Male Plug

001 170 011001 00 00



Topraklı Erkek UPS
Earthed Male Plug UPS

001 170 014001 00 00



Dişi Fiş
Female Socket

001 170 020001 00 00



Topraklı Dişi Fiş
Earthed Female Plug

001 170 021001 00 00



Prizmatik Çocuk Koruma Kapağı
Socketmatic Child Protection Cover

001 888 000001 00 00



Kulplu Topraklı Erkek Fiş
Earthed Male Plug With Handle

001 170 011002 00 00



Arapuar Anahtar
Bakelite Hand Switch

001 170 030001 00 00



İkili Topraklı Fiş Priz
Earthed 2 Gang Socket

001 170 033006 00 00

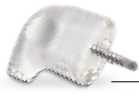

Topraklı Erkek Fiş (Kuyruklu)
Earthed Male Plug (Tailed)

001 170 012001 00 00

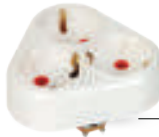

Topraklı Üçlü Fiş Priz
(Yonca Tip) (S/A)
Triple Earthed Socket • Switch
(Yonca Type) (Recessed Mounted)

001 170 033001 00 00



İkili Topraklı Fiş Priz
Earthed 2 Gang Socket

001 170 033006 00 11



Topraklı Erkek Fiş UPS
(Kuyruklu)
Earthed Male Plug Ups
(Tailed)

001 170 013001 00 00



Topraklı Üçlü Fiş Priz
(Yonca Tip) (S/Ü)
Triple Earthed Socket • Switch
(Yonca Type) (Surface Mounted)

001 170 033002 00 00



İkili Topraklı Fiş Priz
Anahtarlı
Earthed 2 Gang Socket
With Switch

001 170 033007 00 11



Adaptör Fiş Priz (İngiliz Tip)
Adepter - Socket (British Type)

001 170 030002 00 00



İkili Topraklı Fiş Priz
Anahtarlı
Earthed 2 Gang Socket
With Switch

001 170 033007 00 00

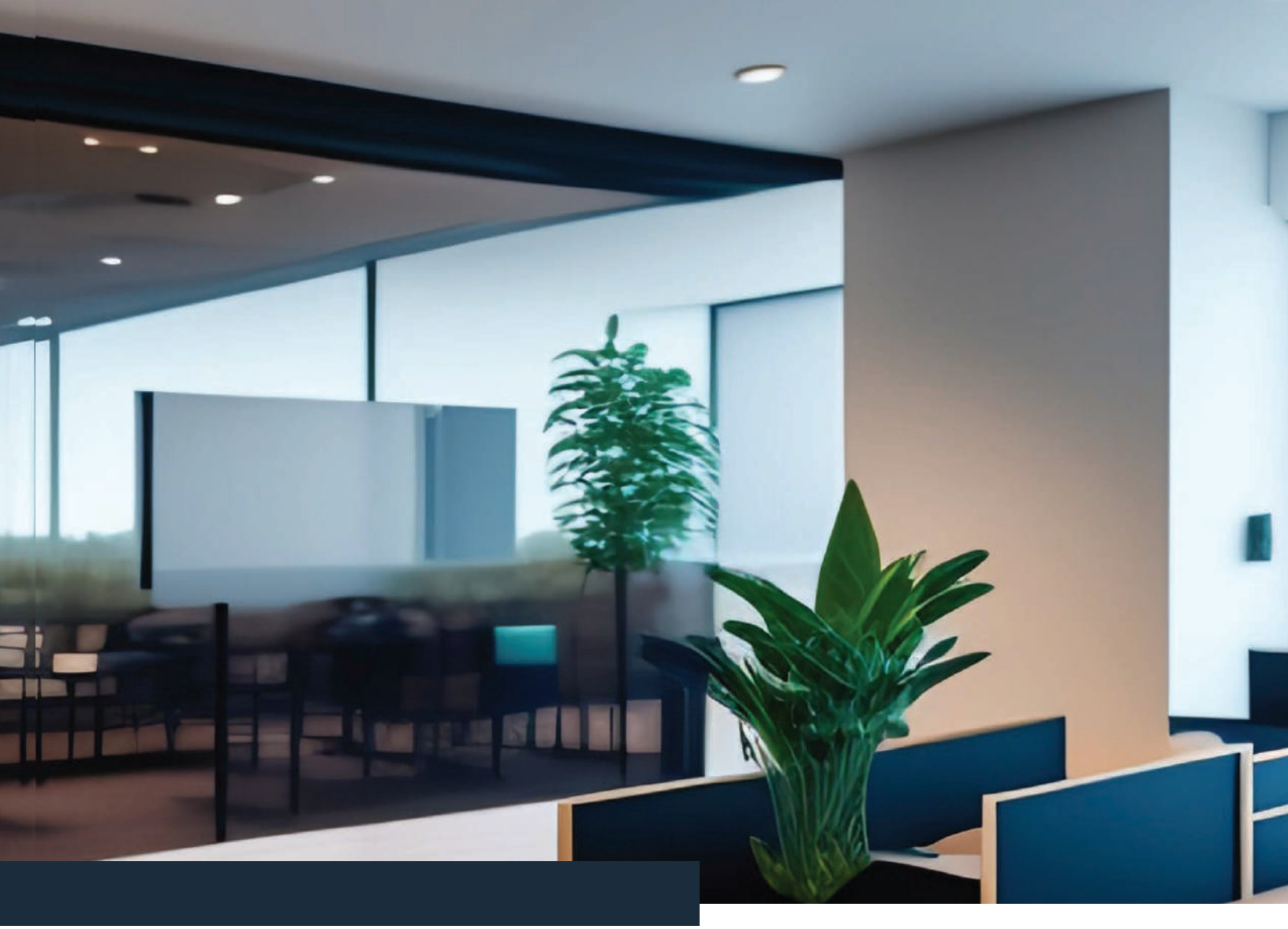

İkili Topraklı Fiş Priz(Düz Tip)
Earthed 2 Gang Socket

001 170 033003 00 00



Üçlü Topraklı Fiş Priz
(Düz Tip Anahtar)
Earthed 3 Gang Socket
With Switch

001 170 033004 00 00



Üçlü Topraklı Fiş Priz(Düz Tip)
Earthed 3 Gang Socket

001 170 033005 00 00

AKSESUAR • ACCESSORIES

Kod Code	Ürün Tanımı Description		Kutu Ağırlık Box Weight (kg)	Hacim Volume (m³)	Kutu Box
001 170 012001 00 00	Topraklı Erkek Fiş (Kuyruklu)	Earthed Male Plug (Tailed)	1,80	0,00500	50
001 170 010001 00 00	Erkek Fiş	Male Socket	0,95	0,00500	50
001 170 013001 00 00	Topraklı Erkek Fiş UPS (Kuyruklu)	Earthed Male Plug Ups (Tailed)	1,80	0,00500	50
001 170 020001 00 00	Dişi Fiş	Female Socket	0,75	0,00500	50
001 170 011001 00 00	Topraklı Erkek Fiş	Earthed Male Plug	1,60	0,00500	50
001 170 021001 00 00	Topraklı Dişi Fiş	Earthed Female Plug	2,40	0,01000	25
001 170 014001 00 00	Topraklı Erkek UPS	Earthed Male Plug Ups	1,80	0,00500	50
001 170 011002 00 00	Kulplu Topraklı Erkek Fiş	Earthed Male Plug With Handle	1,60	0,00500	50
001 170 033001 00 00	Topraklı Üçlü Fiş Priz (Yonca Tip) (S/A)	Triple Earthed Socket • Switch (Yonca Type) (Recessed Mounted)	1,15	0,00600	12
001 170 033002 00 00	Topraklı Üçlü Fiş Priz (Yonca Tip) (S/Ü)	Triple Earthed Socket • Switch (Yonca Type) (Surface Mounted)	4,18	0,02880	36
001 170 030002 00 00	Adaptör Fiş Priz (İngiliz Tip)	Adepter - Socket (British Type)	1,25	0,00500	50
001 170 030001 00 00	Arapuar Anahtar	Bakalite Hand Switch	1,00	0,00500	50
001 170 033003 00 00	İkili Topraklı Fiş Priz(Düz Tip)	Earthed 2 Gang Socket	5,80	0,04000	50
001 170 033005 00 00	Üçlü Topraklı Fiş Priz(Düz Tip)	Earthed 3 Gang Socket	4,64	0,03200	40
001 170 033004 00 00	Üçlü Topraklı Fiş Priz (Düz Tip Anahtar)	Earthed 3 Gang Socket With Switch	3,48	0,02400	36
001 888 000001 00 00	Prizmatik Çocuk Koruma Kapağı	Socketmatic Child Protection Cover	0,30	0,00078	100
001 170 033006 00 11	İkili Topraklı Fiş Priz	Earhted 2 Gang Socket	1,88	0,01344	30
001 170 033006 00 00	İkili Topraklı Fiş Priz	Earhted 2 Gang Socket	1,88	0,01344	30
001 170 033007 00 11	İkili Topraklı Fiş Priz Anahtarlı	Earhted 2 Gang Socket With Switch	2,18	0,00774	28
001 170 033007 00 00	İkili Topraklı Fiş Priz Anahtarlı	Earhted 2 Gang Socket With Switch	2,18	0,00774	28



KABLO KANALLARI ve AKSESUARLARI CABLE TRUNKING and ACCESORIES



@mutlusanelectric



@mutlusanelk



@mutlusanelektrik



@mutlusanplastikelektrik

www.mutlusan.com.tr



**KABLO KANALLARI
RENKLİ KABLO KANALLARI
ZEMİN KABLO KANALLARI
PROMEX DELİKLİ KANALLARI**

**CABLE TRUNKING
COLORED CABLE TRUNKING
FLOOR CABLE TRUNKING
PROMEX SLOTTED TRUNKING**





Güvenliğinizi Artırın
Enhance Your Safety
Estetik ve Düzenli Mekanlar
Aesthetic and Organized Spaces
Uzun Ömürlü ve Dayanıklı Çözümler
Long-Lasting and Durable Solutions
Kolay Kurulum ve Kullanım
Easy Installation and Usage
Çeşitli Boyut ve Modeller
Various Sizes and Models
Çevre Dostu Ürünler
Eco-Friendly Products
Ekonomik ve Verimli Çözümler
Economical and Efficient Solutions



Halojen Free
Halogen Free



Alev Yaymayan
Flame Retardant



Soğuk ve ısıya karşı dayanıklı
-40°C/+60°C
Resistant to cold and heat



Darbelere dayanıklı
Shock resistance



Elektriksel yalıtım özelliğine sahip
Electrically insulated



İstenilen renkte boyanabilir
Can be painted to desired color.



Asit buharına dayanıklı
Resistance to acidic vapor



Katı yabancı maddelerin girişine karşı koruma
Protection against ingress of solid foreign substances



HALOGEN FREE SERİSİ KABLO KANALLARI SERIES CABLE TRUNKING

Zehirli gaz içermeyen, doğa dostu ürünler...

Toxic gas free, Eco-friendly products...

MUTLUSAN FLARET SERİSİ kablo kanalları, üretiminde kullanılan hammadde içeriğinde, 7A grubu (Flor, Klor, Brom, İyot, vb.) zehirli kimyasal elementler bulunmamaktadır (EN 60754-1/2016). Bundan dolayı herhangi bir yanma durumunda çıkan dumanın canlı sağlığına zarar vermemesi özelliği ile yangın güvenliğini artırır.

MUTLUSAN FLARET SERİSİ kablo kanalları, yüksek güvenlik standartlarına (EN 50085-2-1 /2007) uygun olarak tasarlanmış, hem evler hem de iş yerleri için ideal bir çözümdür.

The **MUTLUSAN FLARET** Series cable trunking does not contain toxic chemical elements from Group 7A (Fluorine, Chlorine, Bromine, Iodine, etc.) in the raw materials used in its production process (EN 60754-1/2016). This ensures that the smoke released in the event of a fire does not harm living beings, thereby increasing fire safety.

The **MUTLUSAN FLARET** Series cable trunking is designed in compliance with high safety standards (EN 50085-2-1/2007), making it an ideal solution for both homes and workplaces.



UV ışınlarına karşı dayanıklı
Resistant to UV light

Ultraviyole korumalı kablo kanalları, UV ışınlarına karşı dayanıklı malzemelerden üretilir. Bu tür kablo kanalları, dış mekan uygulamalarında kullanıldığında, güneş ışığı ve atmosfer koşullarına karşı uzun ömürlü ve güvenilir bir çözüm sunar. Kendiliğinden sönmeye özelliğine sahip olup, yüksek kalitede standartlar sunar.

Ultraviolet-protected cable trunking is made from materials resistant to UV rays. When used in outdoor applications, this type of cable trunking offers a long-lasting and reliable solution against sunlight and atmospheric/environmental (alternatif bir kelime kullanılmalı) conditions. It has self-extinguishing properties and meets high-quality standards.

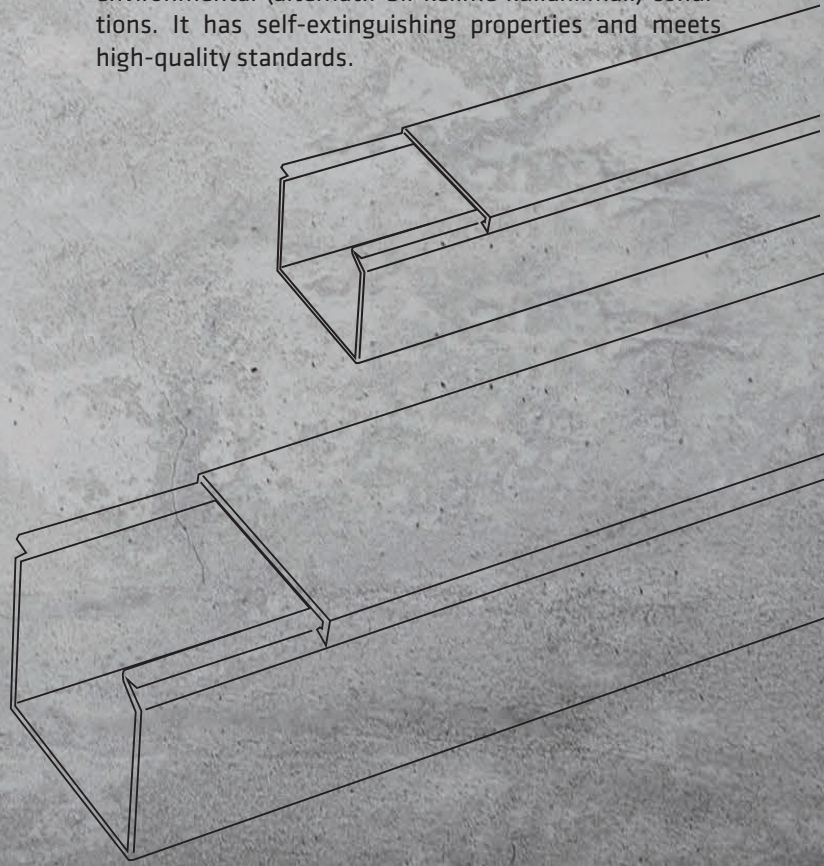

KABLO KANALI CABLE TRUNKING



floret

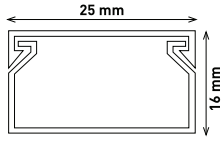

25x16

001 060 025016 20 00

Ambalaj Şekli Packing Type : Kutu- Box

Adet/m Quantity/m : 150 m

Ağırlık Weight : 17,325 kg

m³/ Volume : 0.7636



Aksesuarlar/Accessories

Kod Code	Ürün Product	Adet Quantity	Ağırlık Weight	m ³ Volume
001 039 025016 11 00	İç Köşe Internal Corner	40	0,390 kg	0,00293
001 040 025016 11 00	Dış Köşe External Corner	40	0,484 kg	0,00293
001 041 025016 11 00	T Köşe T Corner	30	0,395 kg	0,00293
001 042 025016 11 00	90° L Köşe 90° L Corner	80	0,720 kg	0,00364
001 043 025016 11 00	Ek Parça Connector	100	0,260 kg	0,00139
001 044 025016 11 00	Uç Tapa Blind Cap	100	0,240 kg	0,00139
001 047 017421 11 00	PM Kasası 1'li Socket Assembly/Frame Single	12	1,290 kg	0,00600

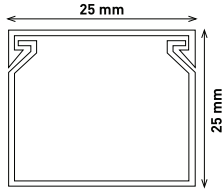

25x25

001 060 025025 20 00

Ambalaj Şekli Packing Type : Kutu- Box

Adet/m Quantity/m : 100 m

Ağırlık Weight : 15,500 kg

m³/ Volume : 0.7636



Kod Code	Ürün Product	Adet Quantity	Ağırlık Weight	m ³ Volume
001 039 025025 11 00	İç Köşe Internal Corner	40	0,424 kg	0,00293
001 040 025025 11 00	Dış Köşe External Corner	40	0,516 kg	0,00293
001 041 025025 11 00	T Köşe T Corner	30	0,405 kg	0,00293
001 042 025025 11 00	90° L Köşe 90° L Corner	50	0,516 kg	0,00293
001 043 025025 11 00	Ek Parça Connector	100	0,184 kg	0,00139
001 044 025025 11 00	Uç Tapa Blind Cap	100	0,310 kg	0,00139
001 047 017421 11 00	PM Kasası 1'li Socket Assembly/Frame Single	12	1,290 kg	0,00600

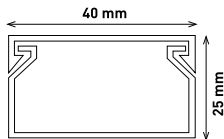

40x25

001 060 04025 20 00

Ambalaj Şekli Packing Type : Kutu- Box

Adet/m Quantity/m : 80 m

Ağırlık Weight : 17,200 kg

m³/ Volume : 0.09272



Kod Code	Ürün Product	Adet Quantity	Ağırlık Weight	m ³ Volume
001 039 040025 11 00	İç Köşe Internal Corner	24	0,449 kg	0,00293
001 040 040025 11 00	Dış Köşe External Corner	30	0,711 kg	0,00293
001 041 040025 11 00	T Köşe T Corner	18	0,407 kg	0,00293
001 042 040025 11 00	90° L Köşe 90° L Corner	24	0,432 kg	0,00293
001 043 040025 11 00	Ek Parça Connector	70	0,353 kg	0,00293
001 044 040025 11 00	Uç Tapa Blind Cap	25	0,158 kg	0,00139

"Mutlusan ile Kablolarınızı Gizleyin, Güvenliği Artırın!"



floret

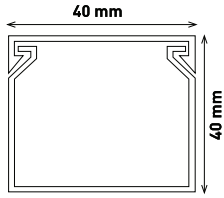

40x40

001 060 04040 20 00

Ambalaj Şekli Packing Type : Kutu- Box

Adet/m Quantity/m : 50 m

Ağırlık Weight : 13,900 kg

m³/ Volume : 0.09272



Aksesuarlar/Accessories

Kod Code	Ürün Product	Adet Quantity	Ağırlık Weight	m ³ Volume
001 039 040040 11 00	İç Köşe Internal Corner	18	0,504 kg	0,00293
001 040 040040 11 00	Dış Köşe External Corner	10	0,320 kg	0,00282
001 041 040040 11 00	T Köşe T Corner	48	0,415 kg	0,01011
001 042 040040 11 00	90° Köşe 90° Corner	60	0,488 kg	0,01011
001 043 040040 11 00	Ek Parça Connector	100	0,722 kg	0,01011
001 044 040040 11 00	Uç Tapa Blind Cap	25	0,210 kg	0,00139

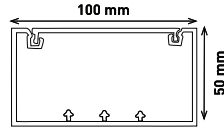

100x50

001 060 100050 20 00

Ambalaj Şekli Packing Type : Kutu- Box

Adet/m Quantity/m : 20 m

Ağırlık Weight : 16,600 kg

m³/ Volume : 0.11554



Kod Code	Ürün Product	Adet Quantity	Ağırlık Weight	m ³ Volume
001 061 100050 20 00	Ara Bölme Partition	150 m	13,500 kg	0,37455
001 039 100050 11 00	İç Köşe Hareketli Internal Corner Live	10	0,800 kg	0,00937
001 040 100050 11 00	Dış Köşe Hareketli External Corner Live	8	1,896 kg	0,00937
001 041 100050 11 00	T Köşe T Corner	10	1,000 kg	0,01312
001 042 100050 11 00	90° L Köşe 90° L Corner	10	1,000 kg	0,01312
001 043 100050 11 00	Ek Parça Connector	100	1,650 kg	0,01000
001 044 100050 11 00	Uç Tapa Blind Cap	40	0,735 kg	0,00400



"Hide Your Cables, Increase Security with Mutlusan!"

KENDİNDEN KAPAKLI KANALLAR

CABLE TRUNKING WITH INTERNAL COVER

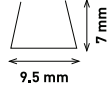
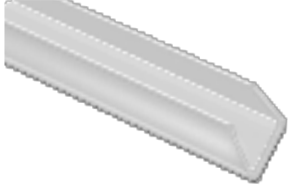

Aksesuarsız
Without Accessories

9.5x7

001 015 010007 20 00

Ambalaj Şekli Packing Type :	Kutu- Box
Adet/m Quantity/m :	500 m
Ağırlık Weight :	16,450 kg
m ³ / Volume :	0.04000

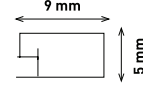
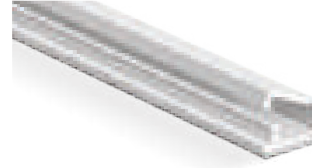

Aksesuarsız
Without Accessories

9x5

001 004 009005 20 00

Ambalaj Şekli Packing Type :	Kutu- Box
Adet/m Quantity/m :	500 m
Ağırlık Weight :	18,400 kg
m ³ / Volume :	0.04000

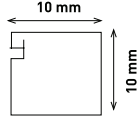

Aksesuarsız
Without Accessories

10x10

001 004 010010 20 00

Ambalaj Şekli Packing Type :	Kutu- Box
Adet/m Quantity/m :	320 m
Ağırlık Weight :	18,176 kg
m ³ / Volume :	0.0400

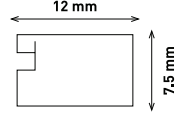
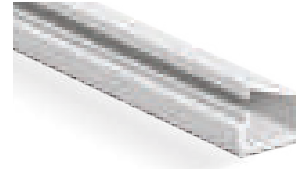

Aksesuarsız
Without Accessories

12x7.5

001 004 012007 20 00

Ambalaj Şekli Packing Type :	Kutu- Box
Adet/m Quantity/m :	350 m
Ağırlık Weight :	18,340 kg
m ³ / Volume :	0.05090

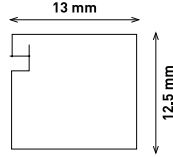
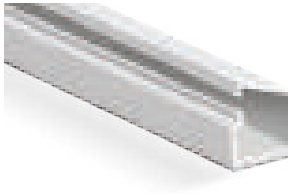

Aksesuarsız
Without Accessories

13x12.5

001 004 013012 20 00

Ambalaj Şekli Packing Type :	Kutu- Box
Adet/m Quantity/m :	300 m
Ağırlık Weight :	24,090 kg
m ³ / Volume :	0.07636

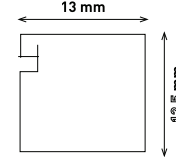
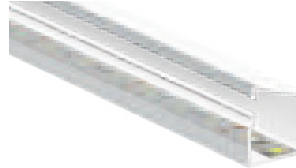

LED
İÇİN ÖZEL

13x12.5

001 004 013012 20 44

Ambalaj Şekli Packing Type :	Kutu- Box
Adet/m Quantity/m :	300 m
Ağırlık Weight :	18,210 kg
m ³ / Volume :	0.07636

DIŞTAN KAPAKLI KANALLAR

CABLE TRUNKING WITH EXTERNAL COVER

Aksesuarsız
Without Accessories

10X8

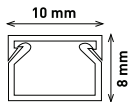

		EKO SERİSİ/SERIES	MEKS SERİSİ/SERIES
Ürün Kodu	Product Code	001 014 010008 20 00	001 002 010008 20 00
Ambalaj Şekli	Packing Type	Kutu - Box	Kutu - Box
Adet / m	Quantity / m	330 m	330 m
Ağırlık	Weight	17,500 kg	17,500 kg
m ³	Volume	0,04000	0,04000

"Kabloları Sakla, Estetiği Ortaya Çıkar!"

DIŐTAN KAPAKLI KANALLAR

CABLE TRUNKING WITH EXTERNAL COVER

Aksesuarsız
Without Accessories



15X15

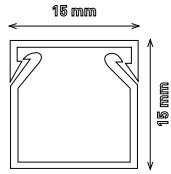

		EKO SERİSİ/SERIES	MEKS SERİSİ/SERIES
Ürün Kodu	Product Code	001 014 015015 20 00	001 002 015015 20 00
Ambalaj Şekli	Packing Type	Kutu - Box	Kutu - Box
Adet / m	Quantity / m	250 m	250 m
Ağırlık	Weight	23 kg	23 kg
m ³	Volume	0,07636	0,07636

20X15

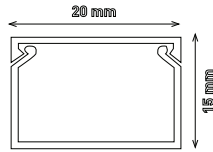

		EKO SERİSİ/SERIES	MEKS SERİSİ/SERIES
Ürün Kodu	Product Code	001 014 020015 20 00	001 002 020015 20 00
Ambalaj Şekli	Packing Type	Kutu - Box	Kutu - Box
Adet / m	Quantity / m	144 m	144 m
Ağırlık	Weight	15,120 kg	15,120 kg
m ³	Volume	0,07636	0,07636

20X20

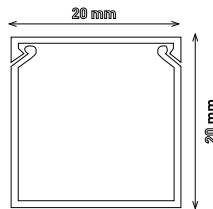

		EKO SERİSİ/SERIES	MEKS SERİSİ/SERIES
Ürün Kodu	Product Code	001 014 020020 20 00	001 002 020020 20 00
Ambalaj Şekli	Packing Type	Kutu - Box	Kutu - Box
Adet / m	Quantity / m	156 m	156 m
Ağırlık	Weight	19,695 kg	19,695 kg
m ³	Volume	0,07636	0,07636

25X40

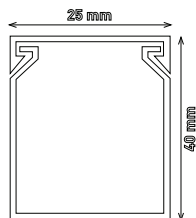

		EKO SERİSİ/SERIES	MEKS SERİSİ/SERIES
Ürün Kodu	Product Code	001 014 025040 20 00	001 002 025040 20 00
Ambalaj Şekli	Packing Type	Kutu - Box	Kutu - Box
Adet / m	Quantity / m	80 m	80 m
Ağırlık	Weight	24,843 kg	24,840 kg
m ³	Volume	0,07636	0,07636

"Hide the Cables, Reveal the Aesthetics!"

DIŐTAN KAPAKLI KANALLAR

CABLE TRUNKING WITH EXTERNAL COVER

Aksesuarsız
Without Accessories



30X15

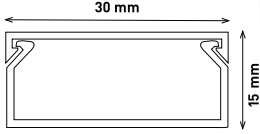

		EKO SERİSİ/SERIES	MEKS SERİSİ/SERIES
Ürün Kodu	Product Code	001 014 030015 20 00	001 002 030015 20 00
Ambalaj Şekli	Packing Type	Kutu - Box	Kutu - Box
Adet / m	Quantity / m	140 m	140 m
Ağırlık	Weight	21,000 kg	21,000 kg
m ³	Volume	0,07636	0,07636

30X30

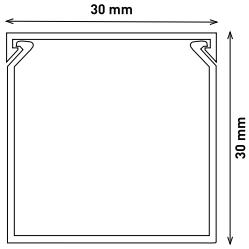

		EKO SERİSİ/SERIES	MEKS SERİSİ/SERIES
Ürün Kodu	Product Code	001 014 030030 20 00	001 002 030030 20 00
Ambalaj Şekli	Packing Type	Kutu - Box	Kutu - Box
Adet / m	Quantity / m	80 m	80 m
Ağırlık	Weight	16,480 kg	16,480 kg
m ³	Volume	0,09272	0,09272

40X17

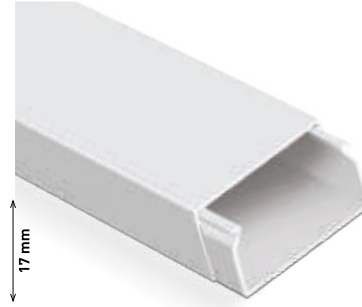
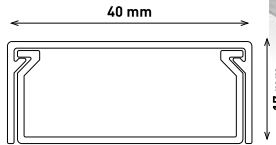

		MEKS SERİSİ/SERIES
Ürün Kodu	Product Code	001 002 040017 20 00
Ambalaj Şekli	Packing Type	Kutu - Box
Adet / m	Quantity / m	100 m
Ağırlık	Weight	26,160 kg
m ³	Volume	0,07636

Tam Kapaklı Full Cover

40X17

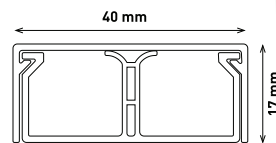

		MEKS SERİSİ/SERIES
Ürün Kodu	Product Code	001 002 940017 20 00
Ambalaj Şekli	Packing Type	Kutu - Box
Adet / m	Quantity / m	100 m
Ağırlık	Weight	28,300 kg
m ³	Volume	0,07636

Tam Kapaklı Bölmeli Full Cover and Partitioned

"Düzenli Kablolar, Güvenli Mekanlar!"

DIŐTAN KAPAKLI KANALLAR

CABLE TRUNKING WITH EXTERNAL COVER

Aksesuarsız
Without Accessories



40X60

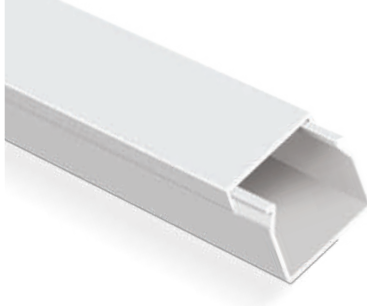
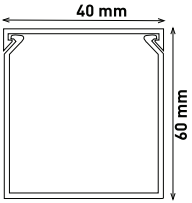

		EKO SERİSİ/SERIES	MEKS SERİSİ/SERIES
Ürün Kodu	Product Code	001 014 040060 20 00	001 002 040060 20 00
Ambalaj Şekli	Packing Type	Kutu - Box	Kutu - Box
Adet / m	Quantity / m	40 m	40 m
Ağırlık	Weight	21,518 kg	21,520 kg
m ³	Volume	0,11029	0,11029

50X50

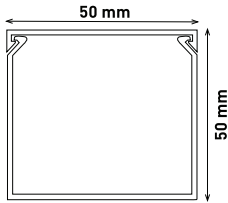

		EKO SERİSİ/SERIES
Ürün Kodu	Product Code	001 014 050050 20 00
Ambalaj Şekli	Packing Type	Kutu - Box
Adet / m	Quantity / m	30 m
Ağırlık	Weight	14,052 kg
m ³	Volume	0,09272

75X75

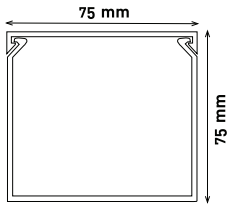

		EKO SERİSİ/SERIES
Ürün Kodu	Product Code	001 014 075075 20 00
Ambalaj Şekli	Packing Type	Kutu - Box
Adet / m	Quantity / m	28 m
Ağırlık	Weight	25,153 kg
m ³	Volume	0,13392

100X100

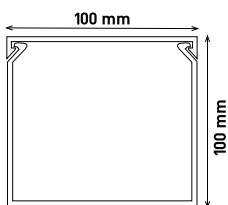

		EKO SERİSİ/SERIES
Ürün Kodu	Product Code	001 014 100100 20 00
Ambalaj Şekli	Packing Type	Kutu - Box
Adet / m	Quantity / m	20 m
Ağırlık	Weight	29,017 kg
m ³	Volume	0,13392

DIŐTAN KAPAKLI KANALLAR

CABLE TRUNKING WITH EXTERNAL COVER



	Adet Quantity	Ađırlık Weight	m ³ Volume
001 039 012012 00 00 İç Köőe Internal Corner	60	0,175 kg	0,00139
001 040 012012 00 00 Dıő Köőe External Corner	60	0,215 kg	0,00139
001 041 012012 00 00 T Köőe T Corner	60	0,195 kg	0,00139
001 042 012012 00 00 90° L Köőe 90° L Corner	60	0,225 kg	0,00139
001 043 012012 00 00 Ek Parça Connector	100	0,165 kg	0,00139
001 044 012012 00 00 Uç Tapa Blind Cap	100	0,145 kg	0,00139

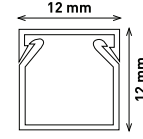

12X12

	EKO SERİŐİ SERIES	MEKS SERİŐİ SERIES	CANALEX SERİŐİ SERIES
Ürün Kodu Product Code	001 014 012012 20 00	001 002 012012 20 00	001 156 012012 20 00
Ambalaj Őekli Packing Type	Kutu - Box	Kutu - Box	Kutu - Box
Adet / m Quantity / m	250 m	250 m	250 m
Ađırlık Weight	17,050 kg	17,050 kg	14,800 kg
m ³ Volume	0,05090	0,05090	0,05090

	Adet Quantity	Ađırlık Weight	m ³ Volume
001 039 015010 00 00	60	0,175 kg	0,00139
001 040 015010 00 00	60	0,175 kg	0,00139
001 041 015010 00 00	60	0,175 kg	0,00139
001 042 015010 00 00	60	0,175 kg	0,00139
001 043 015010 00 00	100	0,175 kg	0,00139
001 044 015010 00 00	100	0,175 kg	0,00139

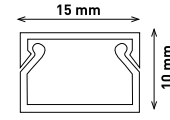

15X10

	EKO SERİŐİ SERIES	MEKS SERİŐİ SERIES	CANALEX SERİŐİ SERIES
Ürün Kodu Product Code	001 014 015010 20 00	001 002 015010 20 00	001 156 015010 20 00
Ambalaj Őekli Packing Type	Kutu - Box	Kutu - Box	Kutu - Box
Adet / m Quantity / m	250 m	250 m	250 m
Ađırlık Weight	19,800 kg	19,800 kg	14,800 kg
m ³ Volume	0,05090	0,05090	0,05090

	Adet Quantity	Ađırlık Weight	m ³ Volume
001 039 016016 00 00 İç Köőe Internal Corner	60	0,240 kg	0,00293
001 040 016016 00 00 Dıő Köőe External Corner	60	0,265 kg	0,00293
001 041 016016 00 00 T Köőe T Corner	60	0,400 kg	0,00293
001 042 016016 00 00 90° L Köőe 90° L Corner	60	0,330 kg	0,00293
001 043 016016 00 00 Ek Parça Connector	100	0,250 kg	0,00139
001 044 016016 00 00 Uç Tapa Blind Cap	100	0,190 kg	0,00139

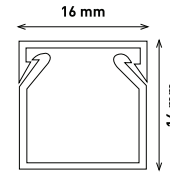

16X16

	EKO SERİŐİ SERIES	MEKS SERİŐİ SERIES	CANALEX SERİŐİ SERIES
Ürün Kodu Product Code	001 014 016016 20 00	001 002 016016 20 00	001 156 016016 20 00
Ambalaj Őekli Packing Type	Kutu - Box	Kutu - Box	Kutu - Box
Adet / m Quantity / m	250 m	250 m	250 m
Ađırlık Weight	17,050 kg	17,050 kg	17,060 kg
m ³ Volume	0,05090	0,05090	0,05090

	Adet Quantity	Ađırlık Weight	m ³ Volume
001 039 020010 00 00 İç Köőe Internal Corner	60	0,200 kg	0,00139
001 040 020010 00 00 Dıő Köőe External Corner	60	0,245 kg	0,00139
001 041 020010 00 00 T Köőe T Corner	60	0,170 kg	0,00139
001 042 020010 00 00 90° L Köőe 90° L Corner	50	0,240 kg	0,00293
001 043 020010 00 00 Ek Parça Connector	100	0,210 kg	0,00139
001 044 020010 00 00 Uç Tapa Blind Cap	100	0,200 kg	0,00139

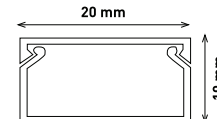

20X10

	EKO SERİŐİ SERIES	MEKS SERİŐİ SERIES	CANALEX SERİŐİ SERIES
Ürün Kodu Product Code	001 014 020010 20 00	001 002 020010 20 00	001 156 020010 20 00
Ambalaj Őekli Packing Type	Kutu - Box	Kutu - Box	Kutu - Box
Adet / m Quantity / m	200 m	200 m	200 m
Ađırlık Weight	17,050 kg	17,050 kg	15,060 kg
m ³ Volume	0,05090	0,05090	0,05090



	Adet Quantity	Ağırlık Weight	m ³ Volume
001 041 023023 00 00 T Köşe T Corner	60	0,258 kg	0,00293
001 042 023023 00 00 90° L Köşe 90° L Corner	60	0,252 kg	0,00293
001 043 023023 00 00 Ek Parça Connector	100	0,150 kg	0,00131
001 044 023023 00 00 Uç Tapa Blind Cap	100	0,180 kg	0,00139

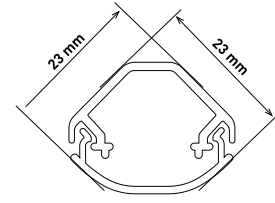

23X23

MEKS SERİSİ SERIES		
Ürün Kodu	Product Code	001 002 023023 20 00
Ambalaj Şekli	Packing Type	Kutu - Box
Adet / m	Quantity / m	120 m
Ağırlık	Weight	23,940 kg
m ³	Volume	0,07636



	Adet Quantity	Ağırlık Weight	m ³ Volume
001 039 025016 00 00 İç Köşe Internal Corner	40	0,390 kg	0,00293
001 040 025016 00 00 Dış Köşe External Corner	40	0,484 kg	0,00293
001 041 025016 00 00 T Köşe T Corner	30	0,720 kg	0,00364
001 042 025016 00 00 90° L Köşe 90° L Corner	80	0,490 kg	0,00293
001 043 025016 00 00 Ek Parça Connector	100	0,260 kg	0,00139
001 044 025016 00 00 Uç Tapa Blind Cap	100	0,240 kg	0,00139
001 047 017421 00 00 PM Kasası 1li Socket Assembly Frame Single	12	1,290 kg	0,00600

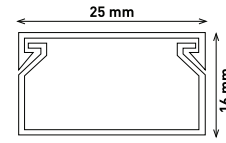

25X16

	EKO SERİSİ SERIES	MEKS SERİSİ SERIES	CANALEX SERİSİ SERIES	
Ürün Kodu	Product Code	001 014 025016 20 00	001 002 025016 20 00	001 156 025016 20 00
Ambalaj Şekli	Packing Type	Kutu - Box	Kutu - Box	Kutu - Box
Adet / m	Quantity / m	150 m	150 m	150 m
Ağırlık	Weight	20,606 kg	20,606 kg	18,110 kg
m ³	Volume	0,07636	0,07636	0,07636



	Adet Quantity	Ağırlık Weight	m ³ Volume
001 039 025025 00 00 İç Köşe Internal Corner	40	0,424 kg	0,00293
001 040 025025 00 00 Dış Köşe External Corner	40	0,516 kg	0,00293
001 041 025025 00 00 T Köşe T Corner	24	0,405 kg	0,00293
001 042 025025 00 00 90° L Köşe 90° L Corner	40	0,516 kg	0,00293
001 043 025025 00 00 Ek Parça Connector	50	0,184 kg	0,00139
001 044 025025 00 00 Uç Tapa Blind Cap	100	0,310 kg	0,00139
001 047 017421 00 00 PM Kasası 1li Socket Assembly Frame Single	12	1,290 kg	0,00600

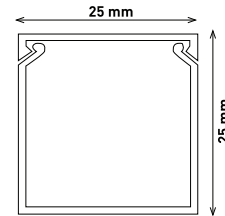

25X25

	EKO SERİSİ SERIES	MEKS SERİSİ SERIES	CANALEX SERİSİ SERIES	
Ürün Kodu	Product Code	001 014 025025 20 00	001 002 025025 20 00	001 156 025025 20 00
Ambalaj Şekli	Packing Type	Kutu - Box	Kutu - Box	Kutu - Box
Adet / m	Quantity / m	100 m	100 m	100 m
Ağırlık	Weight	18,760 kg	18,760 kg	17,360 kg
m ³	Volume	0,05090	0,05090	0,05090



	Adet Quantity	Ağırlık Weight	m ³ Volume
001 039 030010 00 00 İç Köşe Internal Corner	60	0,175 kg	0,00139
001 040 030010 00 00 Dış Köşe External Corner	60	0,175 kg	0,00139
001 041 030010 00 00 T Köşe T Corner	60	0,175 kg	0,00139
001 042 030010 00 00 90° L Köşe 90° L Corner	60	0,175 kg	0,00139
001 043 030010 00 00 Ek Parça Connector	60	0,175 kg	0,00139
001 044 030010 00 00 Uç Tapa Blind Cap	60	0,175 kg	0,00139



Bölmeli Partitioned

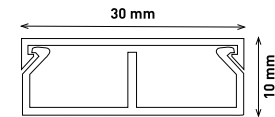

30X10

	EKO SERİSİ SERIES	MEKS SERİSİ SERIES	
Ürün Kodu	Product Code	001 014 930010 20 00	001 002 930010 20 00
Ambalaj Şekli	Packing Type	Kutu - Box	Kutu - Box
Adet / m	Quantity / m	140 m	140 m
Ağırlık	Weight	18,410 kg	18,410 kg
m ³	Volume	0,05090	0,05090

DIŐAN KAPAKLI KANALLAR

CABLE TRUNKING WITH EXTERNAL COVER



	Adet Quantity	Ađırlık Weight	m ³ Volume
001 039 030016 00 00 İç Köőe Internal Corner	35	0,380 kg	0,00293
001 040 030016 00 00 Dıő Köőe External Corner	48	0,605 kg	0,00293
001 041 030016 00 00 T Köőe T Corner	40	0,565 kg	0,00293
001 042 030016 00 00 90° L Köőe 90° L Corner	50	0,535 kg	0,00293
001 043 030025 00 00 Ek Para Connector	100	0,340 kg	0,00293
001 044 030025 00 00 U Tapa Blind Cap	100	0,405 kg	0,00140
001 047 017421 00 00 PM Kasası 1li Socket Assembly Frame Single	12	1,290 kg	0,00600

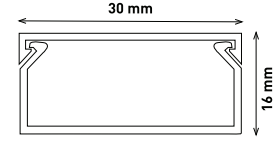

30X16

		EKO SERİSİ SERIES	MEKS SERİSİ SERIES	CANALEX SERİSİ SERIES
Ürün Kodu	Product Code	001 014 030016 20 00	001 002 030016 20 00	001 156 030016 20 00
Ambalaj Őekli	Packing Type	Kutu - Box	Kutu - Box	Kutu - Box
Adet / m	Quantity / m	140 m	140 m	140 m
Ađırlık	Weight	23,282 kg	23,282 kg	20,720 kg
m ³	Volume	0,07636	0,07636	0,07636

	Adet Quantity	Ađırlık Weight	m ³ Volume
001 039 030016 00 00 İç Köőe Internal Corner	35	0,308 kg	0,00293
001 040 030016 00 00 Dıő Köőe External Corner	48	0,605 kg	0,00293
001 041 030016 00 00 T Köőe T Corner	40	0,565 kg	0,00293
001 042 030016 00 00 90° L Köőe 90° L Corner	50	0,535 kg	0,00293
001 043 030025 00 00 Ek Para Connector	100	0,340 kg	0,00139
001 044 030025 00 00 U Tapa Blind Cap	100	0,405 kg	0,00139
001 047 017421 00 00 PM Kasası 1li Socket Assembly Frame Single	12	1,290 kg	0,00600

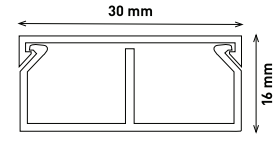

30X16

		EKO SERİSİ SERIES	MEKS SERİSİ SERIES
Ürün Kodu	Product Code	001 014 930016 20 00	001 002 930016 20 00
Ambalaj Őekli	Packing Type	Kutu - Box	Kutu - Box
Adet / m	Quantity / m	140 m	140 m
Ađırlık	Weight	22,860 kg	22,860 kg
m ³	Volume	0,07636	0,07636

	Adet Quantity	Ađırlık Weight	m ³ Volume
001 039 030025 00 00 İç Köőe Internal Corner	32	0,470 kg	0,00293
001 040 030025 00 00 Dıő Köőe External Corner	30	0,530 kg	0,00293
001 041 030025 00 00 T Köőe T Corner	24	0,445 kg	0,00293
001 042 030025 00 00 90° L Köőe 90° L Corner	30	0,430 kg	0,00293
001 043 030025 00 00 Ek Para Connector	100	0,340 kg	0,00293
001 044 030025 00 00 U Tapa Blind Cap	100	0,405 kg	0,00140
001 047 017421 00 00 PM Kasası 1li Socket Assembly Frame Single	12	1,290 kg	0,00600

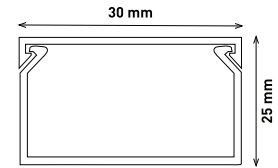

30X25

		EKO SERİSİ SERIES	MEKS SERİSİ SERIES
Ürün Kodu	Product Code	001 014 030025 20 00	001 002 030025 20 00
Ambalaj Őekli	Packing Type	Kutu - Box	Kutu - Box
Adet / m	Quantity / m	80 m	80 m
Ađırlık	Weight	15,860 kg	15,860 kg
m ³	Volume	0,07636	0,07636

	Adet Quantity	Ađırlık Weight	m ³ Volume
001 039 040016 00 00 İç Köőe Internal Corner	32	0,432 kg	0,00293
001 040 040016 00 00 Dıő Köőe External Corner	30	0,519 kg	0,00293
001 041 040016 00 00 T Köőe T Corner	24	0,461 kg	0,00293
001 042 040016 00 00 90° L Köőe 90° L Corner	34	0,524 kg	0,00293
001 043 040040 00 00 Ek Para Connector	100	0,753 kg	0,00937
001 044 040040 00 00 U Tapa Blind Cap	50	0,200 kg	0,00182
001 047 017421 00 00 PM Kasası 1li Socket Assembly Frame Single	12	1,290 kg	0,00600

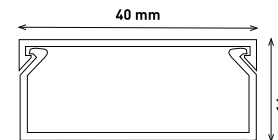
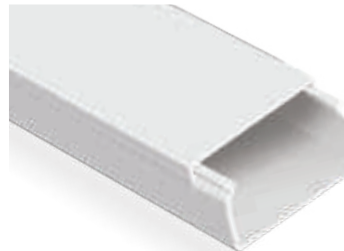

40X16

		EKO SERİSİ SERIES	MEKS SERİSİ SERIES	CANALEX SERİSİ SERIES
Ürün Kodu	Product Code	001 014 040016 20 00	001 002 040016 20 00	001 0156 040016 20 00
Ambalaj Őekli	Packing Type	Kutu - Box	Kutu - Box	Kutu - Box
Adet / m	Quantity / m	100 m	100 m	100 m
Ađırlık	Weight	18,900 kg	18,900 kg	17,660 kg
m ³	Volume	0,07636	0,07636	0,07636



	Adet Quantity	Ağırlık Weight	m ³ Volume
001 039 040016 00 00 İç Köşe Internal Corner	32	0,432 kg	0,00293
001 040 040016 00 00 Dış Köşe External Corner	30	0,519 kg	0,00293
001 041 040016 00 00 T Köşe T Corner	24	0,461 kg	0,00293
001 042 040016 00 00 90° L Köşe 90° L Corner	34	0,524 kg	0,00293
001 043 040040 00 00 Ek Parça Connector	100	0,753 kg	0,00937
001 044 040040 00 00 Uç Tapa Blind Cap	25	0,210 kg	0,00139
001 047 017421 00 00 PM Kasası 1li Socket Assembly Frame Single	12	1,290 kg	0,00600

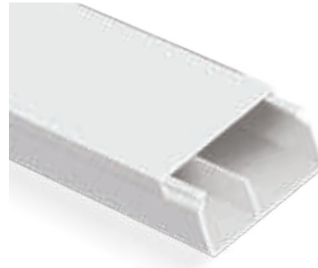

Bölmeli Partitioned

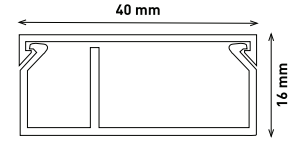

40X16

	EKO SERİSİ SERIES	MEKS SERİSİ SERIES
Ürün Kodu Product Code	001 014 940016 20 00	001 002 940016 20 00
Ambalaj Şekli Packing Type	Kutu - Box	Kutu - Box
Adet / m Quantity / m	100 m	100 m
Ağırlık Weight	23,160 kg	23,160 kg
m ³ Volume	0,07636	0,07636

	Adet Quantity	Ağırlık Weight	m ³ Volume
001 039 040025 00 00 İç Köşe Internal Corner	24	0,449 kg	0,00293
001 040 040025 00 00 Dış Köşe External Corner	30	0,711 kg	0,00293
001 041 040025 00 00 T Köşe T Corner	18	0,407 kg	0,00293
001 042 040025 00 00 90° L Köşe 90° L Corner	24	0,432 kg	0,00293
001 043 040040 00 00 Ek Parça Connector	100	0,722 kg	0,01011
001 044 040040 00 00 Uç Tapa Blind Cap	50	0,350 kg	0,00182
001 047 017421 00 00 PM Kasası 1li Socket Assembly Frame Single	12	1,290 kg	0,00600

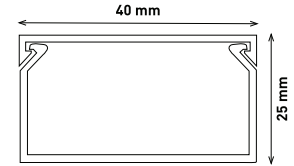

40X25

	EKO SERİSİ SERIES	MEKS SERİSİ SERIES	CANALEX SERİSİ SERIES
Ürün Kodu Product Code	001 014 040025 20 00	001 002 040025 20 00	001 156 040025 20 00
Ambalaj Şekli Packing Type	Kutu - Box	Kutu - Box	Kutu - Box
Adet / m Quantity / m	80 m	80 m	80 m
Ağırlık Weight	19,640 kg	19,640 kg	17,200 kg
m ³ Volume	0,09272	0,09272	0,09272

	Adet Quantity	Ağırlık Weight	m ³ Volume
001 039 040040 01 00 İç Köşe Internal Corner	18	0,540 kg	0,00289
001 040 040040 01 00 Dış Köşe External Corner	16	0,496 kg	0,00289
001 041 040040 00 00 T Köşe T Corner	48	1,415 kg	0,01011
001 042 040040 00 00 90° L Köşe 90° L Corner	60	1,488 kg	0,01011
001 043 040040 00 00 Ek Parça Connector	100	0,800 kg	0,00937
001 044 040040 00 00 Uç Tapa Blind Cap	50	0,350 kg	0,00182

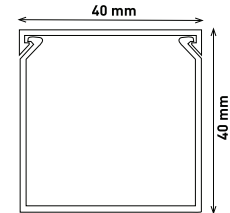
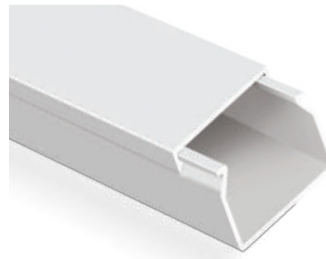

40X40

	EKO SERİSİ SERIES	MEKS SERİSİ SERIES	CANALEX SERİSİ SERIES
Ürün Kodu Product Code	001 014 040040 20 00	001 002 040040 20 00	001 156 040040 20 00
Ambalaj Şekli Packing Type	Kutu - Box	Kutu - Box	Kutu - Box
Adet / m Quantity / m	50 m	50 m	50 m
Ağırlık Weight	15,500 kg	15,500 kg	14,150 kg
m ³ Volume	0,09272	0,09272	0,09272

	Adet Quantity	Ağırlık Weight	m ³ Volume
001 039 060025 00 00 İç Köşe Internal Corner	48	1,192 kg	0,01011
001 040 060025 00 00 Dış Köşe External Corner	72	1,781 kg	0,01011
001 041 060025 00 00 T Köşe T Corner	40	1,250 kg	0,01011
001 042 060025 00 00 90° L Köşe 90° L Corner	60	2,190 kg	0,01008
001 043 060060 00 00 Ek Parça Connector	25	0,372 kg	0,00293
001 044 060025 00 00 Uç Tapa Blind Cap	50	0,510 kg	0,00293
001 047 017421 00 00 PM Kasası 1li Socket Assembly Frame Single	12	1,290 kg	0,00600

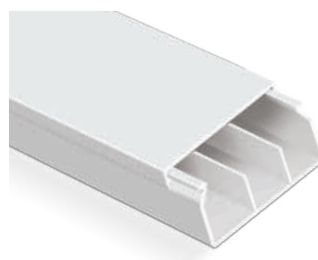

Bölmeli Partitioned

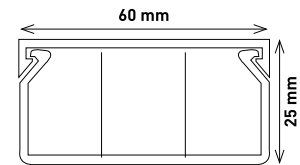

60X25

	EKO SERİSİ SERIES	MEKS SERİSİ SERIES
Ürün Kodu Product Code	001 014 690025 20 00	001 002 690025 20 00
Ambalaj Şekli Packing Type	Kutu - Box	Kutu - Box
Adet / m Quantity / m	40 m	40 m
Ağırlık Weight	17,140 kg	17,140 kg
m ³ Volume	0,07636	0,07636

DIŐTAN KAPAKLI KANALLAR

CABLE TRUNKING WITH EXTERNAL COVER



	Adet Quantity	Ađırlık Weight	m ³ Volume
001 039 060040 00 00 İç Köőe Internal Corner	26	1,160 kg	0,01011
001 040 060040 00 00 Dıő Köőe External Corner	32	1,225 kg	0,01011
001 041 060040 00 00 T Köőe T Corner	32	1,180 kg	0,01011
001 042 060040 00 00 90° L Köőe 90° L Corner	40	1,375 kg	0,01011
001 043 060040 00 00 Ek Parça Connector	25	0,372 kg	0,00293
001 044 060040 00 00 Uç Tapa Blind Cap	30	0,975 kg	0,00294

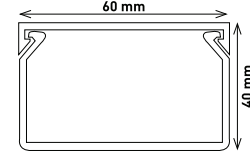

60X40

		EKO SERİŐİ SERIES	MEKS SERİŐİ SERIES	CANALEX SERİŐİ SERIES
Ürün Kodu	Product Code	001 014 060040 20 00	001 002 060040 20 00	001 156 060040 20 00
Ambalaj Őekli	Packing Type	Kutu - Box	Kutu - Box	Kutu - Box
Adet / m	Quantity / m	40 m	40 m	40 m
Ađırlık	Weight	16,400 kg	16,400 kg	15,518 kg
m ³	Volume	0,11029	0,11029	0,11029

	Adet Quantity	Ađırlık Weight	m ³ Volume
001 039 060060 00 00 İç Köőe Internal Corner	16	1,123 kg	0,01011
001 040 060060 00 00 Dıő Köőe External Corner	16	1,361 kg	0,01011
001 041 060060 00 00 T Köőe T Corner	20	1,406 kg	0,01011
001 042 060060 00 00 90° L Köőe 90° L Corner	24	1,691 kg	0,01011
001 043 060060 00 00 Ek Parça Connector	25	0,372 kg	0,00293
001 044 060060 00 00 Uç Tapa Blind Cap	30	0,975 kg	0,00294

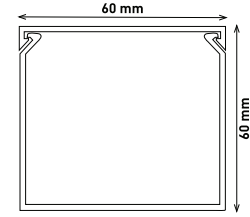

60X60

		EKO SERİŐİ SERIES	MEKS SERİŐİ SERIES	CANALEX SERİŐİ SERIES
Ürün Kodu	Product Code	001 014 060060 20 00	001 002 060060 20 00	001 156 060060 20 00
Ambalaj Őekli	Packing Type	Kutu - Box	Kutu - Box	Kutu - Box
Adet / m	Quantity / m	32 m	32 m	32 m
Ađırlık	Weight	20,445 kg	20,445 kg	18,717 kg
m ³	Volume	0,13392	0,13392	0,13392

	Adet Quantity	Ađırlık Weight	m ³ Volume
001 039 080040 00 00 İç Köőe Internal Corner	18	1,107 kg	0,01011
001 040 080040 00 00 Dıő Köőe External Corner	8	0,839 kg	0,00653
001 041 080040 00 00 T Köőe T Corner	12	1,194 kg	0,01011
001 042 080040 00 00 90° L Köőe 90° L Corner	16	1,386 kg	0,01011
001 043 080040 00 00 Ek Parça Connector	100	1,200 kg	0,00937
001 044 080040 00 00 Uç Tapa Blind Cap	60	0,887 kg	0,00293

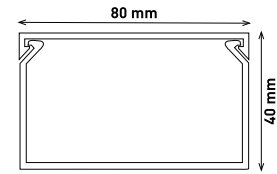

80X40

		EKO SERİŐİ SERIES	MEKS SERİŐİ SERIES	CANALEX SERİŐİ SERIES
Ürün Kodu	Product Code	001 014 080040 20 00	001 002 080040 20 00	001 156 080040 20 00
Ambalaj Őekli	Packing Type	Kutu - Box	Kutu - Box	Kutu - Box
Adet / m	Quantity / m	30 m	30 m	30 m
Ađırlık	Weight	19,518 kg	19,518 kg	17,118 kg
m ³	Volume	0,11029	0,11029	0,11029

	Adet Quantity	Ađırlık Weight	m ³ Volume
001 039 080060 00 00 İç Köőe Internal Corner	12	0,980 kg	0,01011
001 040 080060 00 00 Dıő Köőe External Corner	8	0,898 kg	0,00653
001 041 080060 00 00 T Köőe T Corner	10	1,237 kg	0,01011
001 042 080060 00 00 90° L Köőe 90° L Corner	12	1,287 kg	0,01010
001 043 080060 00 00 Ek Parça Connector	80	1,120 kg	0,00937
001 044 080060 00 00 Uç Tapa Blind Cap	48	0,944 kg	0,00293

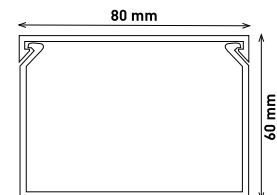

80X60

		EKO SERİŐİ SERIES	MEKS SERİŐİ SERIES	CANALEX SERİŐİ SERIES
Ürün Kodu	Product Code	001 014 080060 20 00	001 002 080060 20 00	001 156 080060 20 00
Ambalaj Őekli	Packing Type	Kutu - Box	Kutu - Box	Kutu - Box
Adet / m	Quantity / m	24 m	24 m	24 m
Ađırlık	Weight	17,232 kg	17,232 kg	16,157 kg
m ³	Volume	0,13392	0,13392	0,13392



	Adet Quantity	Ağırlık Weight	m ³ Volume
001 013 100040 00 00 Ara Bölme Partition	200m	21,050 kg	0,05040
001 039 100040 00 00 İç Köşe Internal Corner	8	0,795 kg	0,01011
001 039 100040 01 00 İç Köşe Hareketli Internal Corner Live	10	1,651 kg	0,01312
001 040 100040 00 00 Dış Köşe External Corner	8	0,905 kg	0,00653
001 040 100040 01 00 Dış Köşe Hareketli External Corner Live	10	0,959 kg	0,00817
001 041 100040 00 00 T Köşe T Corner	12	1,344 kg	0,01010
001 042 100040 00 00 90°L Köşe 90°L Corner	12	1,233 kg	0,01011
001 043 100060 00 00 Ek Parça Connector	100	0,966 kg	0,01011
001 044 100060 00 00 Uç Tapa Blind Cap	16	0,396 kg	0,00182
001 050 030004 00 00 Kilitleme Aparatı Locking Apparatus	100	0,280 kg	0,00100

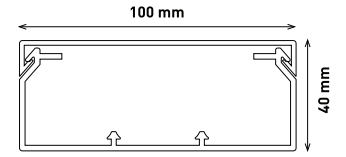

100X40

	EKO SERİSİ SERIES	MEKS SERİSİ SERIES	CANALEX SERİSİ SERIES
Ürün Kodu Product Code	001 014 100040 20 00	001 002 100040 20 00	001 156 100040 20 00
Ambalaj Şekli Packing Type	Kutu - Box	Kutu - Box	Kutu - Box
Adet / m Quantity / m	24 m	24 m	24 m
Ağırlık Weight	18,648 kg	21,918 kg	16,380 kg
m ³ Volume	0,11029	0,11029	0,11029



	Adet Quantity	Ağırlık Weight	m ³ Volume
001 013 100048 20 00 Ara Bölme Partition	150m	19,605 kg	0,07500
001 039 100048 00 00 İç Köşe Internal Corner	8	0,915 kg	0,01011
001 039 100060 01 00 İç Köşe Hareketli Internal Corner Live	10	1,190 kg	0,01312
001 040 100048 00 00 Dış Köşe External Corner	8	0,918 kg	0,00653
001 040 100060 01 00 Dış Köşe Hareketli External Corner Live	10	1,120 kg	0,01011
001 041 100048 00 00 T Köşe T Corner	8	1,008 kg	0,01011
001 042 100048 00 00 90°L Köşe 90°L Corner	8	0,936 kg	0,01011
001 043 100060 00 00 Ek Parça Connector	100	0,966 kg	0,01011
001 044 100060 00 00 Uç Tapa Blind Cap	20	0,529 kg	0,00293
001 050 030004 00 00 Kilitleme Aparatı Locking Apparatus	100	0,280 kg	0,00100

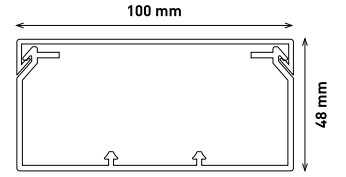

100X48

	EKO SERİSİ SERIES	MEKS SERİSİ SERIES	CANALEX SERİSİ SERIES
Ürün Kodu Product Code	001 002 100048 20 00		
Ambalaj Şekli Packing Type	Kutu - Box		
Adet / m Quantity / m	24 m		
Ağırlık Weight	24 m	25,757 kg	
m ³ Volume	19,700 kg	0,13392	



	Adet Quantity	Ağırlık Weight	m ³ Volume
001 013 100060 20 00 Ara Bölme Partition	130m	19,360 kg	0,07956
001 039 100060 00 00 İç Köşe Internal Corner	8	0,969 kg	0,01011
001 039 100060 01 00 İç Köşe Hareketli Internal Corner Live	10	1,190 kg	0,01312
001 040 100060 00 00 Dış Köşe External Corner	8	0,988 kg	0,00653
001 040 100060 01 00 Dış Köşe Hareketli External Corner Live	10	1,120 kg	0,01011
001 041 100060 00 00 T Köşe T Corner	8	1,067 kg	0,01011
001 042 100060 00 00 90°L Köşe 90°L Corner	8	1,080 kg	0,01011
001 043 100060 00 00 Ek Parça Connector	100	0,966 kg	0,01011
001 044 100060 00 00 Uç Tapa Blind Cap	20	0,529 kg	0,00293
001 050 030004 00 00 Kilitleme Aparatı Locking Apparatus	100	0,280 kg	0,00100

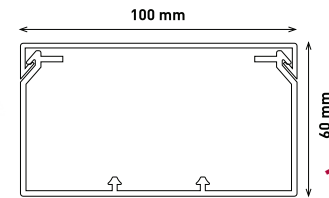

100X60

	EKO SERİSİ SERIES	MEKS SERİSİ SERIES	CANALEX SERİSİ SERIES
Ürün Kodu Product Code	001 014 100060 20 00	001 002 100060 20 00	001 156 100060 20 00
Ambalaj Şekli Packing Type	Kutu - Box	Kutu - Box	Kutu - Box
Adet / m Quantity / m	20 m	20 m	20 m
Ağırlık Weight	19,700 kg	22,757 kg	18,557 kg
m ³ Volume	0,13392	0,13392	0,13392



	Adet Quantity	Ağırlık Weight	m ³ Volume
001 013 120060 20 00 Ara Bölme Partition	130m	20,010 kg	0,07956
001 039 120060 00 00 İç Köşe Internal Corner	8	0,939 kg	0,01011
001 039 100060 01 00 İç Köşe Hareketli Internal Corner Live	10	1,190 kg	0,01312
001 040 120060 00 00 Dış Köşe External Corner	8	0,860 kg	0,00653
001 040 100060 01 00 Dış Köşe Hareketli External Corner Live	10	1,120 kg	0,01011
001 041 120060 00 00 T Köşe T Corner	8	1,050 kg	0,01011
001 042 120060 00 00 90°L Köşe 90°L Corner	8	1,116 kg	0,01011
001 043 120060 00 00 Ek Parça Connector	50	1,229 kg	0,01011
001 044 120060 00 00 Uç Tapa Blind Cap	20	0,612 kg	0,00293
001 050 030004 00 00 Kilitleme Aparatı Locking Apparatus			

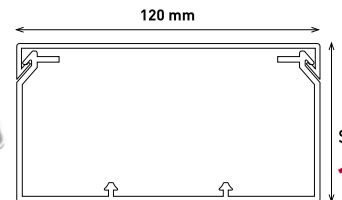

120X60

	EKO SERİSİ SERIES	MEKS SERİSİ SERIES
Ürün Kodu Product Code	001 014 120060 20 00	001 002 120060 20 00
Ambalaj Şekli Packing Type	Kutu - Box	Kutu - Box
Adet / m Quantity / m	16 m	16 m
Ağırlık Weight	21,949 kg	21,949 kg
m ³ Volume	0,13392	0,13392

MEKSPUS SERİSİ İÇTEN KAPAKLI KANALLAR

MEKSPUS SERIES INTERNAL COVER CABLE TRUNKING



KORUMA BANTLI PROTECTING FOIL

	Adet Quantity	Ağırlık Weight	m ³ Volume
001 013 100037 20 00 Ara Bölme Partition	200m	19,650 kg	0,05040
001 039 100037 00 00 İç Köşe Internal Corner	12	0,807 kg	0,01011
001 039 100050 01 00 İç Köşe Hareketli Internal Corner Live	10	0,800 kg	0,00937
001 040 100037 00 00 Dış Köşe External Corner	8	0,723 kg	0,00653
001 040 100050 01 00 Dış Köşe Hareketli External Corner Live	8	0,880 kg	0,00653
001 041 100037 00 00 T Köşe T Corner	14	1,418 kg	0,01365
001 042 100037 00 00 90°L Köşe 90°L Corner	14	1,400 kg	0,01365
001 043 100050 00 00 Ek Parça Connector	100	1,590 kg	0,01000
001 044 100037 00 00 Uç Tapa Blind Cap	50	0,790 kg	0,00293

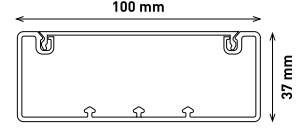
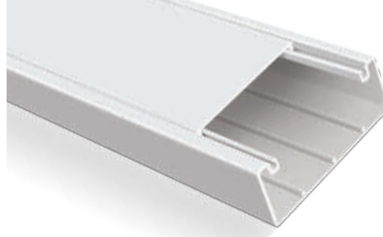

100X37

		EKO SERİSİ SERIES	MEKS SERİSİ SERIES	MEKSPUS SERİSİ SERIES
Ürün Kodu	Product Code	001 014 100037 20 00	001 002 100037 20 00	001 003 100037 20 00
Ambalaj Şekli	Packing Type	Kutu - Box	Kutu - Box	Kutu - Box
Adet / m	Quantity / m	30 m	30 m	30 m
Ağırlık	Weight	28,017 kg	29,067 kg	29,067 kg
m ³	Volume	0,13392	0,13392	0,13392

	Adet Quantity	Ağırlık Weight	m ³ Volume
001 013 100040 20 00 Ara Bölme Partition	200m	21,050 kg	0,05040
001 039 100050 00 00 İç Köşe Internal Corner	8	0,600 kg	0,01011
001 039 100050 01 00 İç Köşe Hareketli Internal Corner Live	10	0,800 kg	0,00937
001 040 100050 00 00 Dış Köşe External Corner	8	0,880 kg	0,00653
001 040 100050 01 00 Dış Köşe Hareketli External Corner Live	10	0,896kg	0,00939
001 041 100050 00 00 T Köşe T Corner	10	1,000 kg	0,01364
001 042 100050 00 00 90°L Köşe 90°L Corner	10	1,012 kg	0,01364
001 043 100050 00 00 Ek Parça Connector	100	1,590 kg	0,01000
001 044 100050 00 00 Uç Tapa Blind Cap	40	0,736 kg	0,00400

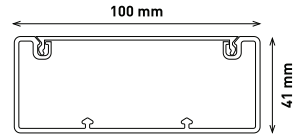
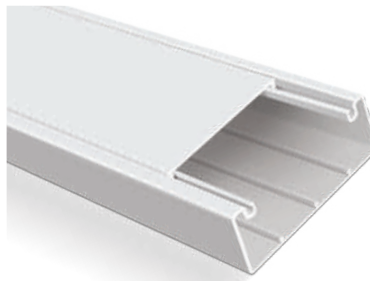

100X41

		MEKS SERİSİ SERIES	MEKSPUS SERİSİ SERIES
Ürün Kodu	Product Code	001 002 100041 20 00	001 003 100041 20 00
Ambalaj Şekli	Packing Type	Kutu - Box	Kutu - Box
Adet / m	Quantity / m	24 m	24 m
Ağırlık	Weight	24,318 kg	21,840 kg
m ³	Volume	0,11029	0,11029

	Adet Quantity	Ağırlık Weight	m ³ Volume
001 013 100048 20 00 Ara Bölme Partition	150m	19,605 kg	0,07500
001 039 100050 00 00 İç Köşe Internal Corner	8	0,600 kg	0,01011
001 039 100050 01 00 İç Köşe Hareketli Internal Corner Live	10	1,800 kg	0,00937
001 040 100050 00 00 Dış Köşe External Corner	8	0,896 kg	0,00937
001 040 100050 01 00 Dış Köşe Hareketli External Corner Live	8	0,896 kg	0,00939
001 041 100050 00 00 T Köşe T Corner	10	1,000 kg	0,01364
001 042 100050 00 00 90°L Köşe 90°L Corner	10	1,012 kg	0,01364
001 043 100050 00 00 Ek Parça Connector	100	1,590 kg	0,01000
001 044 100050 00 00 Uç Tapa Blind Cap	40	0,736 kg	0,00400
001 043 100050 01 00 Ek Parça (3'lü set) Connector (3 set)	100	1,300 kg	0,00937
001 046 195100 00 00 Kanal İçi Küp Buat Duct Junction Cube	25	0,408 kg	0,00828

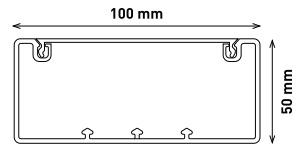

100X50

Kanal İçi Küp Buat
Duct Junction Cube



		CANALEX SERİSİ SERIES	EKO SERİSİ SERIES	MEKS SERİSİ SERIES	MEKSPUS SERİSİ SERIES
Ürün Kodu	Product Code	001 156 100050 20 00	001 014 100050 20 00	001 002 100050 20 00	001 003 100050 20 00
Ambalaj Şekli	Packing Type	Kutu - Box	Kutu - Box	Kutu - Box	Kutu - Box
Adet / m	Quantity / m	20 m	20 m	20 m	20 m
Ağırlık	Weight	17,400 kg	17,880 kg	21,000 kg	21,000 kg
m ³	Volume	0,11554	0,11554	0,11554	0,11554

Kablolarınız İçin Profesyonel Çözümler! Professional Solutions for Your Cables!

Kaidesiz

Compatible With Mounting Without Base



	Adet Quantity	Ağırlık Weight	m ³ Volume
001 013 100048 20 00 Ara Bölme Partition	150m	20,100 kg	0,07500
001 039 100051 00 00 İç Köşe Internal Corner	8	0,496 kg	0,01011
001 040 100051 00 00 Dış Köşe External Corner	8	0,880 kg	0,00653
001 041 100051 00 00 T Köşe T Corner	10	0,488 kg	0,01312
001 042 100051 00 00 90° L Köşe 90° L Corner	10	0,800 kg	0,01312
001 043 100051 00 00 Ek Parça Connector	100	0,350 kg	0,00400
001 044 100051 00 00 Uç Tapa Blind Cap	40	0,350 kg	0,00282
001 888 100050 00 00 Kilitleme Aparatı Locking Apparatus	50	0,350 kg	0,00282

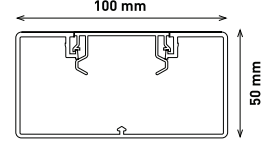

100X50

MEKSPLUS
SERİSİ SERIES

Ürün Kodu	Product Code	001 006 100050 20 00
Ambalaj Şekli	Packing Type	Kutu - Box
Adet / m	Quantity / m	20 m
Ağırlık	Weight	23,020 kg
m ³	Volume	0,11554

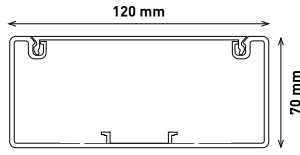
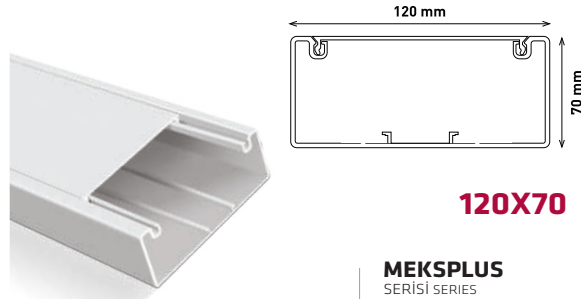

120X70

MEKSPLUS
SERİSİ SERIES

Ürün Kodu	Product Code	001 003 120070 20 00
Ambalaj Şekli	Packing Type	Kutu - Box
Adet / m	Quantity / m	16 m
Ağırlık	Weight	25,673 kg
m ³	Volume	0,13392

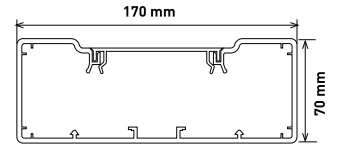
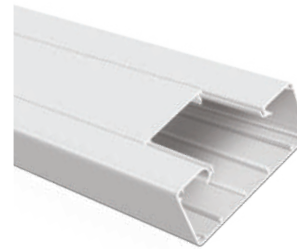

170X70

MEKSPLUS
SERİSİ SERIES

Ürün Kodu	Product Code	001 003 170070 20 00
Ambalaj Şekli	Packing Type	Kutu - Box
Adet / m	Quantity / m	12 m
Ağırlık	Weight	29,365 kg
m ³	Volume	0,11551

Aksesuarlar Accessories

	Adet Quantity	Ağırlık Weight	m ³ Volume
001 013 120070 20 00 Ara Bölme Partition	60m	10,160 kg	0,07956

Aksesuarlar Accessories

	Adet Quantity	Ağırlık Weight	m ³ Volume
001 013 120070 20 00 Ara Bölme Partition	60m	10,160 kg	0,07956



	Adet Quantity	Ağırlık Weight	m ³ Volume
001 039 170050 00 00 İç Köşe Internal Corner	32	2,8480 kg	0,07500
001 040 170050 00 00 Dış Köşe External Corner	44	3,872 kg	0,04812
001 041 170050 00 00 T Köşe T Corner	16	3,749 kg	0,00653
001 042 170050 00 00 90° L Köşe 90° L Corner	16	2,997 kg	0,01364
001 043 170050 00 00 Ek Parça Connector	125	19,000 kg	0,01364
001 044 170050 00 00 Uç Tapa Blind Cap	125	4,250 kg	0,01000

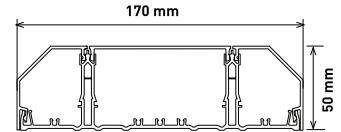
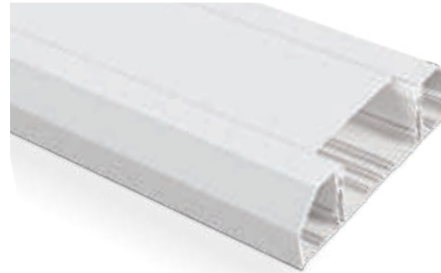

170X50

MEKSPLUS
SERİSİ SERIES

Ürün Kodu	Product Code	001 003 170050 20 00
Ambalaj Şekli	Packing Type	Kutu - Box
Adet / m	Quantity / m	12 m
Ağırlık	Weight	25,560 kg
m ³	Volume	0,11551

"Ofisinizde kusursuz düzen, Mutlusan ile mümkün!"

"Perfect order in your office is possible with Mutlusan!"

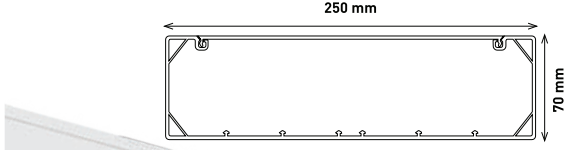

250X70

Priz Montaj Setsiz
Without Plug Socket Assembly Set

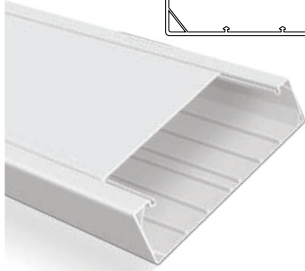

		MEKSPLUS SERİSİ SERIES
Ürün Kodu	Product Code	001 003 250070 20 00
Ambalaj Şekli	Packing Type	Kutu - Box
Adet / m	Quantity / m	8 m
Ağırlık	Weight	22,952 kg
m ³	Volume	0,16665

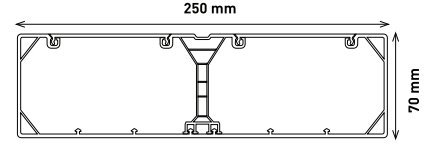

250X70

Bölmeli Partitionet

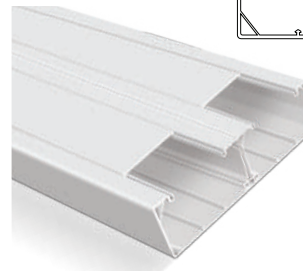

		MEKSPLUS SERİSİ SERIES
Ürün Kodu	Product Code	001 003 250970 20 00
Ambalaj Şekli	Packing Type	Kutu - Box
Adet / m	Quantity / m	8 m
Ağırlık	Weight	25,848 kg
m ³	Volume	0,16665

	Adet Quantity	Ağırlık Weight	m ³ Volume
001 013 100040 20 00 İç Köşe Internal Corner	20	0,402 kg	0,00293
001 039 100050 00 00 Dış Köşe External Corner	20	0,424 kg	0,00293
001 039 100050 01 00 T Köşe T Corner	30	1,350 kg	0,01011
001 040 100050 00 00 90° L Köşe 90° L Corner	40	1,444 kg	0,01011
001 040 100050 01 00 Ek Parça Connector	50	0,430 kg	0,00293
001 041 100050 00 00 Uç Tapa Blind Cap	50	0,550 kg	0,00293
001 042 100050 00 00 P,M Kasası Socket Assembly Frame	6	0,574 kg	0,00300
001 043 100050 00 00 P,M Kasası 1'li Socket Assembly Frame Single	12	1,290 kg	0,00600

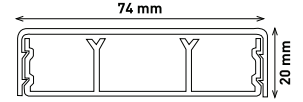

74X20

Tam Kapaklı Bölmeli
Full Cover and Partitioned

		EKO SERİSİ SERIES	MEKS SERİSİ SERIES
Ürün Kodu	Product Code	001 014 974020 20 00	001 002 974020 20 00
Ambalaj Şekli	Packing Type	Kutu - Box	Kutu - Box
Adet / m	Quantity / m	50 m	50 m
Ağırlık	Weight	29,295 kg	29,295 kg
m ³	Volume	0,09272	0,09272

	Adet Quantity	Ağırlık Weight	m ³ Volume
001 039 075022 00 00 İç Köşe Internal Corner	20	0,446 kg	0,01010
001 040 075022 00 00 Dış Köşe External Corner	20	0,471 kg	0,01010
001 043 075022 01 00 Ek Parça Connector	100	0,500 kg	0,00290
001 044 075022 01 00 Sağ Uç Tapa External Corner	30	0,195 kg	0,00138
001 044 075022 02 00 Sol Uç Tapa External Corner Live	20	0,130 kg	0,00092

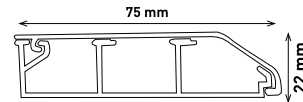

75X22

		MEKSPLUS SERİSİ SERIES
Ürün Kodu	Product Code	001 002 975022 20 00
Ambalaj Şekli	Packing Type	Kutu - Box
Adet / m	Quantity / m	50 m
Ağırlık	Weight	33,743 kg
m ³	Volume	0,09272

İÇTEN KAPAKLI KANALLAR PRİZ MONTAJ SETLERİ

SOCKET ASSEMBLY ADAPTOR FOR INTERNAL COVER TRUNKINGS

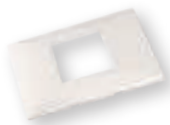
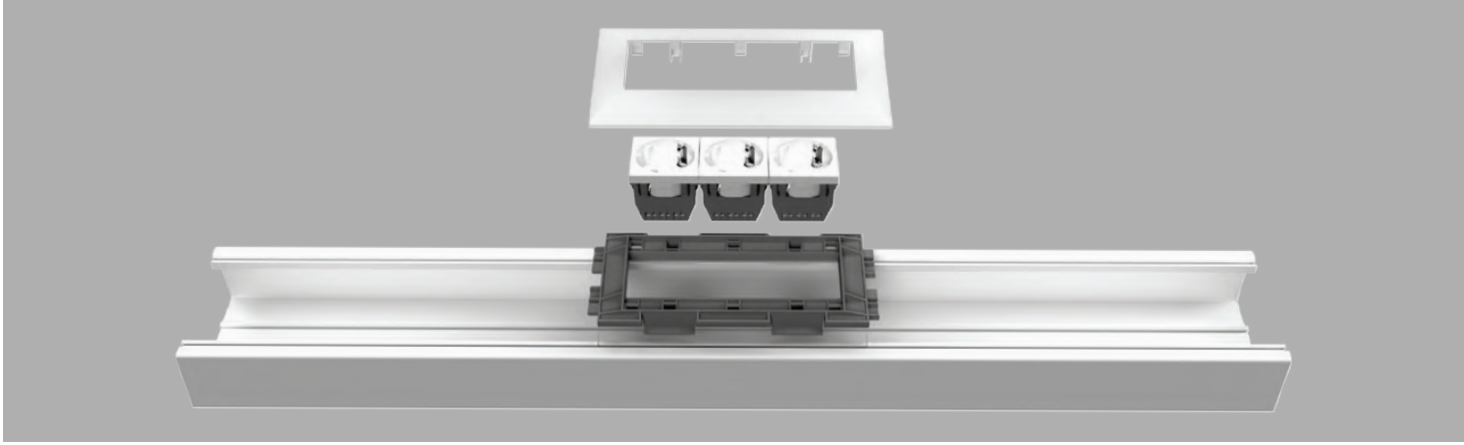

45X45
TEKLİ ÇERÇEVE
SINGLE FRAME



45X45
İKİLİ ÇERÇEVE
DOUBLE FRAME



45X45
ÜÇLÜ ÇERÇEVE
TRIPLE FRAME



45X45
DÖRTLÜ ÇERÇEVE
QUARTET FRAME

Ürün Kodu	Product Code	001 047 070001 00 00	001 047 070002 00 00	001 047 070003 00 00	001 047 070004 00 00
Ambalaj Şekli	Packing Type	Kutu - Box	Kutu - Box	Kutu - Box	Kutu - Box
Adet	Quantity	30	16	14	13
Ağırlık	Weight	1,118 kg	1,072 kg	1,079 kg	1,181 kg
m ³	Volume	0,00600	0,00560	0,00600	0,00617



55X55
TEKLİ ÇERÇEVE
SINGLE FRAME



55X55
İKİLİ ÇERÇEVE
DOUBLE FRAME



55X55
ÜÇLÜ ÇERÇEVE
TRIPLE FRAME

Ürün Kodu	Product Code	001 047 080001 00 00	001 047 080002 00 00	001 014 100037 20 00
Ambalaj Şekli	Packing Type	Kutu - Box	Kutu - Box	Kutu - Box
Adet	Quantity	20	14	10
Ağırlık	Weight	1,275 kg	1,308 kg	1,212 kg
m ³	Volume	0,00652	0,00666	0,00667



001 052 300001 00 00

45X45
TOPRAKLI PRİZ
ÇEKİRDEKLERİ 45°
EARTHED SOCKET
CORES 45°



001 052 300002 00 00

45X45
UPS PRİZ
ÇEKİRDEKLERİ 45°
UPS SOCKET
CORES 45°



001 052 200005 00 00

45X45
UPS VE TOPRAKLI PRİZ
BİRLEŞTİRME APARATI
UPS AND EARTHED
SOCKET CONNECTION
APPARATUS



001 052 200003 00 00

45X45
UPS VE TOPRAKLI PRİZ
BİRLEŞTİRME APARATI (YAN)
UPS AND EARTHED
SOCKET CONNECTION
APPARATUS (SIDE)



001 050 030003 00 00

100X37/50
KANAL KİLİTLEME
APARATI
TRUNKING LOCKING
APPARATUS

İNGİLİZ NORMU PRİZ MONTAJ SETLERİ

BRITISH NORM PLUG SOCKET ASSEMBLY SETS

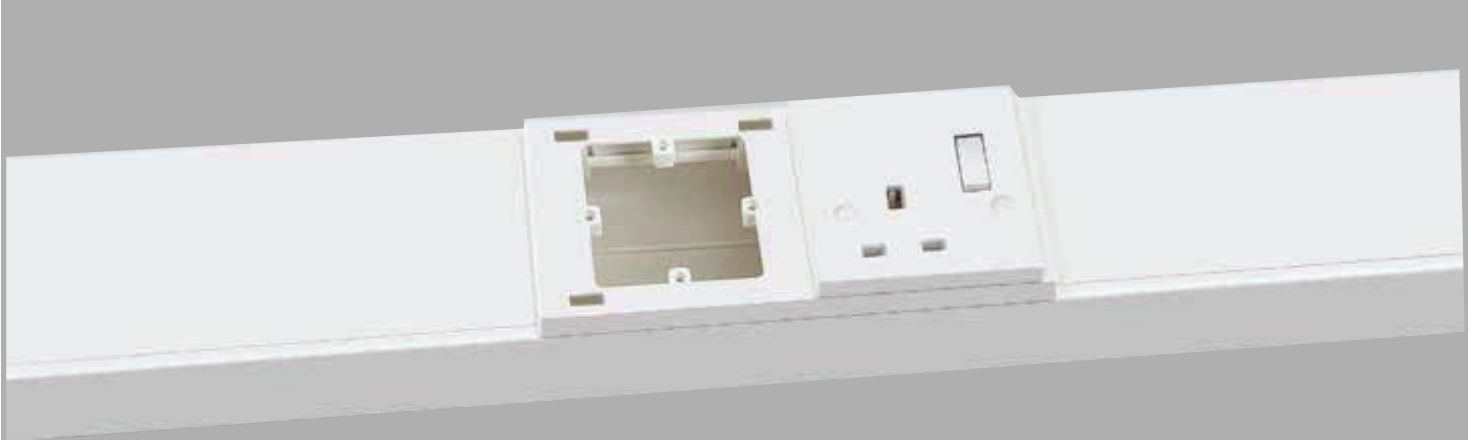

100X50



İNGİLİZ NORMU TEKLİ PRİZ TABANI

BRITISH NORM SINGLE
SOCKET BASE

Ürün Kodu	Product Code	001 047 980001 00 00
Ambalaj Şekli	Packing Type	Kutu - Box
Adet / m	Quantity / m	200 ad.
Ağırlık	Weight	3,850 kg
m ³	Volume	0,04000

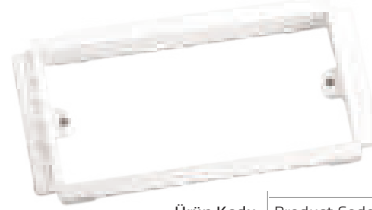

İNGİLİZ NORMU İKİLİ PRİZ TABANI

BRITISH NORM DOUBLE
SOCKET BASE

Ürün Kodu	Product Code	001 047 980002 00 00
Ambalaj Şekli	Packing Type	Kutu - Box
Adet / m	Quantity / m	100 ad.
Ağırlık	Weight	2,480 kg
m ³	Volume	0,04000



İNGİLİZ NORMU İKİLİ YÜKSEK TİP PRİZ TABANI

BRITISH NORM DOUBLE
HIGH TYPE SOCKET BASE

Ürün Kodu	Product Code	001 047 990002 00 00
Ambalaj Şekli	Packing Type	Kutu - Box
Adet / m	Quantity / m	94 ad.
Ağırlık	Weight	5,076 kg
m ³	Volume	0,03196



MODÜLER TİP KANAL ÜSTÜ MONTAJ ÇERÇEVESİ

MODULER SYSTEM
EXTERNAL COVER SOCKET
ASSEMBLY FRAME

Ürün Kodu	Product Code	001 047 950002 00 00
Ambalaj Şekli	Packing Type	Kutu - Box
Adet / m	Quantity / m	36 m
Ağırlık	Weight	1,116 kg
m ³	Volume	0,00636



İNGİLİZ NORMU TEKLİ MONTAJ KASASI

BRITISH NORM DOUBLE
SOCKET BASE

Ürün Kodu	Product Code	001 047 050001 00 00
Ambalaj Şekli	Packing Type	Kutu - Box
Adet / m	Quantity / m	138 ad.
Ağırlık	Weight	4,416 kg
m ³	Volume	0,03416

170X50



İNGİLİZ NORMU İKİLİ MONTAJ KASASI

BRITISH NORM DOUBLE
SOCKET BASE

Ürün Kodu	Product Code	001 047 050002 00 00
Ambalaj Şekli	Packing Type	Kutu - Box
Adet / m	Quantity / m	92 ad.
Ağırlık	Weight	4,784 kg
m ³	Volume	0,03416



SIVAALTI ANAHTAR KASASI (KARE BUAT)

FLUSH MOUNTED SWITCH
CASING (SQUARE JUNCTION BOX)

Ürün Kodu	Product Code	001 166 000001 00 00
Ambalaj Şekli	Packing Type	Kutu - Box
Adet / m	Quantity / m	28 ad.
Ağırlık	Weight	1,176 kg
m ³	Volume	0,01120

**Kablolarınız İçin
Profesyonel
Çözümler!**
Professional Solutions
for Your Cables!

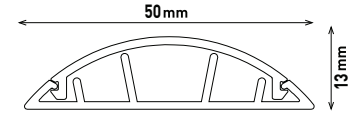

50X13

Ürün Kodu	Product Code	001 002 050013 20 17
Ambalaj Şekli	Packing Type	Kutu - Box
Adet / m	Quantity / m	60 m
Ağırlık	Weight	23,400 kg
m ³	Volume	0,104000

	Adet	Quantity	Ağırlık	Weight	m ³	Volume
001 041 060015 00 17 T Köşe T Corner	10		0,492 kg		0,00300	
001 042 060015 00 17 L Köşe L Corner	24		0,495 kg		0,00240	
001 043 060015 00 17 Ek Parça Connector	50		0,245 kg		0,00139	
001 044 060015 00 17 Uç Tapa Blind Cap	50		0,240 kg		0,00139	

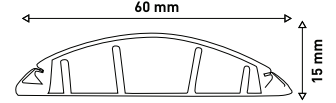

60X15

Ürün Kodu	Product Code	001 002 060015 20 17
Ambalaj Şekli	Packing Type	Kutu - Box
Adet / m	Quantity / m	40 m
m ³	Volume	0,04000
Ağırlık	Weight	14,572 kg

	Adet	Quantity	Ağırlık	Weight	m ³	Volume
001 041 075018 00 17 T Köşe T Corner	8		0,440 kg		0,00293	
001 042 075018 00 17 L Köşe L Corner	15		0,400 kg		0,00293	
001 043 075018 00 17 Ek Parça Connector	50		0,200 kg		0,00139	
001 044 075018 00 17 Uç Tapa Blind Cap	50		0,270 kg		0,00139	

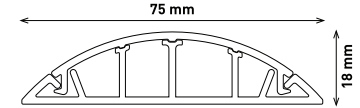

75X18

Ürün Kodu	Product Code	001 002 075018 20 17
Ambalaj Şekli	Packing Type	Kutu - Box
Adet / m	Quantity / m	30 m
m ³	Volume	0,04000
Ağırlık	Weight	19,239 kg

	Adet	Quantity	Ağırlık	Weight	m ³	Volume
001 041 090020 00 17 T Köşe T Corner	12		1,030kg		0,00960	
001 042 090020 00 17 L Köşe L Corner	20		0,765 kg		0,00600	
001 043 090020 00 17 Ek Parça Connector	50		0,220 kg		0,00505	
001 044 090020 00 17 Uç Tapa Blind Cap	50		0,310 kg		0,00244	

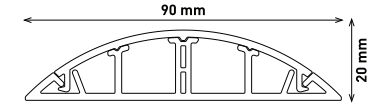

90X20

Ürün Kodu	Product Code	001 002 090020 20 17
Ambalaj Şekli	Packing Type	Kutu - Box
Adet / m	Quantity / m	20 m
m ³	Volume	0,04000
Ağırlık	Weight	16,580 kg

KLİMA KANALI AIR CONDITIONING TRUNKING

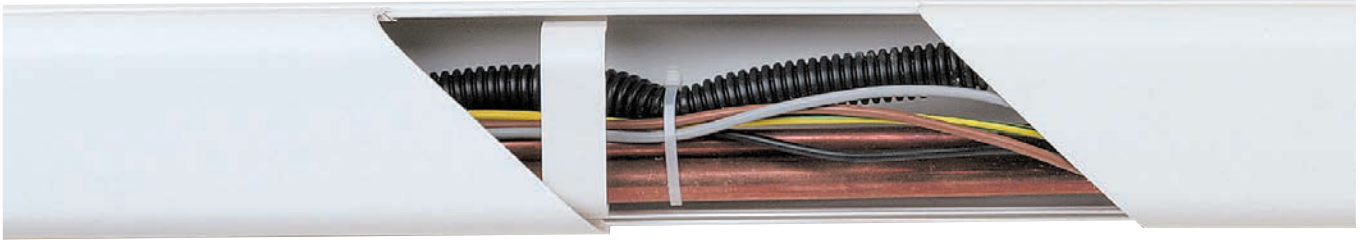

	Adet Quantity	Ağırlık Weight	m ³ Volume
001 039 075060 00 00 İç Köşe Internal Corner	24	0,895 kg	0,01011
001 040 075060 00 00 Dış Köşe External Corner	24	1,265 kg	0,01011
001 042 075060 00 00 90° L Köşe 90° L Corner	18	1,115 kg	0,01011
001 043 100037 00 00 Ek Parça Connector	40	0,380 kg	0,00293
001 044 100050 01 00 İç Uç Tapa Internal Blind Cap	30	0,980 kg	0,01011
001 044 100037 02 00 Dış Uç Tapa External Blind Cap	18	0,820 kg	0,01011
001 050 030001 00 00 Duvar Geçişli Wall Penetration	60	0,905 kg	0,01011
001 050 030002 00 00 Kablo Tutucu Cable Holder	60	0,460 kg	0,00293

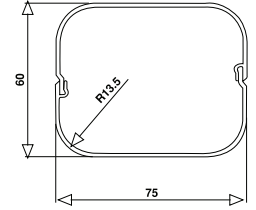
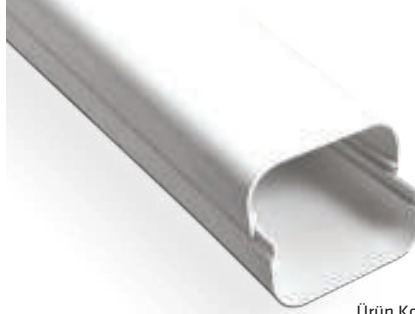

75X60

MEKS
SERİSİ SERIES

Ürün Kodu	Product Code	001 002 075060 20 00
Ambalaj Şekli	Packing Type	Kutu - Box
Adet / m	Quantity / m	30 m
Ağırlık	Weight	18,643 kg
m ³ Volume		0,09272

KLİMA KANALI VE AKSESUARLARI AIR CONDITIONING TRUNKING AND ACCESSORIES

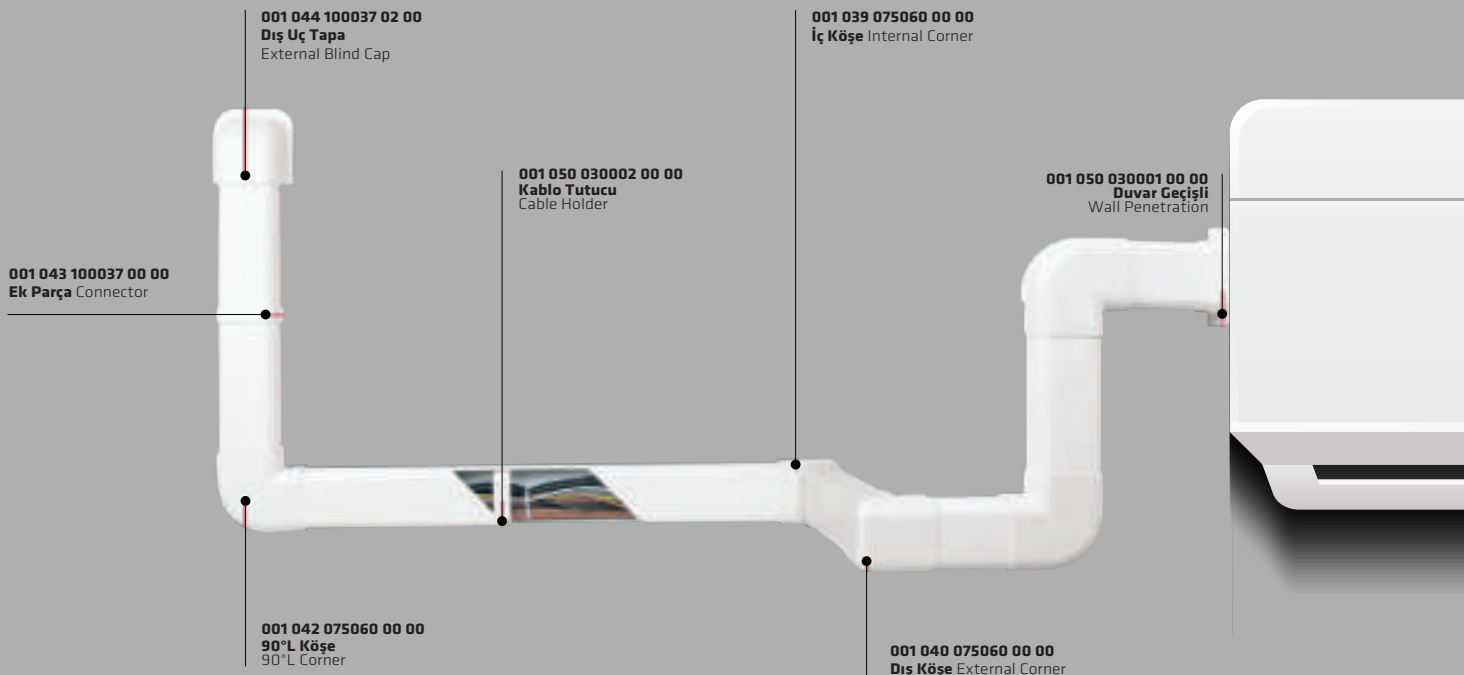



SİDEM

SERİSİ SERIES

"Doğadan esinlendik,
Sidem Serisini
sizlere getirdik!"

"We were inspired by nature,
we brought the Sidem Series to you!"

RENK SEÇENEKLERİ COLOR OPTIONS



ARMUT
PEAR
MUT - 01



MERBAU
MERBAU
MUT - 02



KOYU CEVİZ
DARK WALNUT
MUT - 03



AÇIK KAYIN
LIGHT BEECH
MUT - 04



MAUN
MAHOGANY
MUT - 05



SİYAH
BLACK
MUT - 11



DAMARLI BEJ
RIBBED BEIGE
MUT - 51



KIZIL KAHVE
SCARLET BROWN
MUT - 52



DAMARLI KAHVE
RIBBED BROWN
MUT - 53



DAMARLI AÇIK BEJ
RIBBED LIGHT BEIGE
MUT - 54



DAMARLI KIZIL
RIBBED SCARLET
MUT - 55



GÜMÜŞ
SILVER
MUT - 56

Tüm ebatlarda kablo kanalları ve aksesuarları bu bölümdeki renk seçenekleri ile boyanabilir öze liklerdedir.

The cable trunking and accessories of all sizes can be painted with the available colour options presented in this chapter.



COMFORT

SİGORTA VE ZAYIF AKIM KUTUSU
FUSE AND WEAK CURRENT BOX

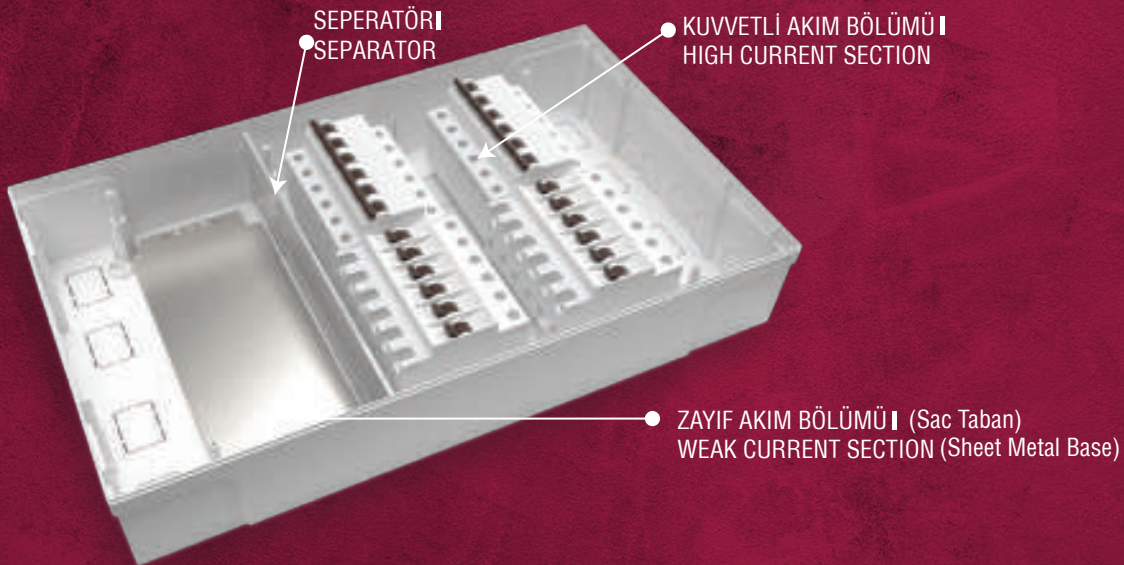

COMFORT W OTOMAT KUTULARI

COMFORT FUSE BOXES

TERMİNAL KORUMA SEVİYESİ (Koruma Sınıfı) TERMINAL PROTECTION LEVEL (Protection Class)	IP40
KUTU TİPİ TYPES OF BOXES	DİKDÖRTGEN KUTULAR RECTANGULAR BOXES
TESİS SIRASINDAKİ SICAKLIK ARALIĞI THE TEMPERATURE RANGE DURING INSTALLATION	-25°C / +60°C
YALITIM DİRENCİ INSULATION RESISTANCE	5MΩ 'un ÜZERİNDE OVER 5MΩ
YÜKSEK GERİLİME DAYANIM HIGH TENSILE RESISTANCE	3750 V AC (220V /400V*50 Hz)



BOYUTLAR DIMENSION

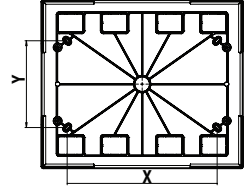
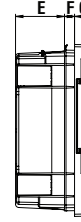
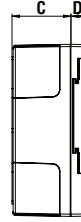
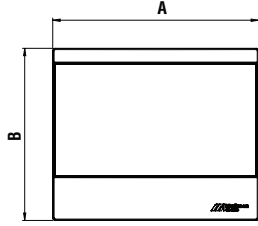

SIVA ALTI FLUSH	A	B	E	F	G
6	167 mm	180 mm	65,5	13,5	18,5
9	221 mm	180 mm	65,5	13,5	18,5
12	275 mm	230 mm	65,5	13,5	18,5
18	383 mm	230 mm	65,5	13,5	18,5
24	275 mm	345 mm	65,5	13,5	18,5
36	275 mm	460 mm	65,5	13,5	18,5

SIVA ÜSTÜ SURFACE	A	B	C	D	X	Y
6	167 mm	180 mm	78,8	18,5	70 mm	80 mm
9	221 mm	180 mm	78,8	18,5	133 mm	80 mm
12	275 mm	230 mm	78,8	18,5	204 mm	118 mm
18	383 mm	230 mm	78,8	18,5	312 mm	118 mm
24	275 mm	345 mm	78,8	18,5	204 mm	233 mm
36	275 mm	460 mm	78,8	18,5	204 mm	348 mm

SIVA ÜSTÜ W OTOMAT KUTUSU

SURFACE-MOUNTED FUSE BOX



001 057 100006 00 00	ALEV YAYAN FLAMMABLE
001 057 120006 00 00	HALOGEN FREE ALEV YAYAN FLAMMABLE
001 057 110006 00 00	ALEV YAYMAYAN NON FLAMMABLE

001 057 100009 00 00	ALEV YAYAN FLAMMABLE
001 057 120009 00 00	HALOGEN FREE ALEV YAYAN FLAMMABLE
001 057 110009 00 00	ALEV YAYMAYAN NON FLAMMABLE

6'li SIVA ÜSTÜ W OTOMAT KUTUSU

SURFACE-MOUNTED FUSE BOX, 6 FUSES

Ambalaj Şekli	Packing Type	Kutu - Box
Adet	Quantity	20
Ağırlık	Weight	10,46 / 10,78 / 11,68 kg
m ³	Volume	0,06766

9'li SIVA ÜSTÜ W OTOMAT KUTUSU

SURFACE-MOUNTED FUSE BOX, 9 FUSES

Ambalaj Şekli	Packing Type	Kutu - Box
Adet	Quantity	20
Ağırlık	Weight	12,94 / 13,00 / 13,94 kg
m ³	Volume	0,09150

001 057 100012 00 00	ALEV YAYAN FLAMMABLE
001 057 120012 00 00	HALOGEN FREE ALEV YAYAN FLAMMABLE
001 057 110012 00 00	ALEV YAYMAYAN NON FLAMMABLE

001 057 100018 00 00	ALEV YAYAN FLAMMABLE
001 057 120018 00 00	HALOGEN FREE ALEV YAYAN FLAMMABLE
001 057 110018 00 00	ALEV YAYMAYAN NON FLAMMABLE

12'li SIVA ÜSTÜ W OTOMAT KUTUSU

SURFACE-MOUNTED FUSE BOX, 12 FUSES

Ambalaj Şekli	Packing Type	Kutu - Box
Adet	Quantity	10
Ağırlık	Weight	8,73 / 9,00 / 9,54 kg
m ³	Volume	0,07207

18'li SIVA ÜSTÜ W OTOMAT KUTUSU

SURFACE-MOUNTED FUSE BOX, 18 FUSES

Ambalaj Şekli	Packing Type	Kutu - Box
Adet	Quantity	10
Ağırlık	Weight	12,604 / 12,70 / 13,83 kg
m ³	Volume	0,10181

COMFORT W OTOMAT KUTULARI

COMFORT FUSE BOXES



001 057 100024 00 00 ALEV YAYAN FLAMMABLE
 001 057 120024 00 00  HALOGEN FREE ALEV YAYAN FLAMMABLE
 001 057 110024 00 00    ALEV YAYMAYAN NON FLAMMABLE

24'lü SIVA ÜSTÜ W OTOMAT KUTUSU
 SURFACE-MOUNTED FUSE BOX, 24 FUSES

Ambalaj Şekli	Packing Type	Kutu - Box
Adet	Quantity	5
Ağırlık	Weight	7,447 / 7,10 / 6,175 kg
m ³	Volume	0,05507



001 057 100024 00 00 ALEV YAYAN FLAMMABLE
 001 057 120024 00 00  HALOGEN FREE ALEV YAYAN FLAMMABLE
 001 057 110024 00 00    ALEV YAYMAYAN NON FLAMMABLE

36'lü SIVA ÜSTÜ W OTOMAT KUTUSU
 SURFACE-MOUNTED FUSE BOX, 36 FUSES

Ambalaj Şekli	Packing Type	Kutu - Box
Adet	Quantity	5
Ağırlık	Weight	9,385 / 9,25 / 7,775 kg
m ³	Volume	0,07306

SIVA ALTI W OTOMAT KUTUSU

FLUSH-MOUNTED FUSE BOXES



001 057 000006 00 00 ALEV YAYAN FLAMMABLE
 001 057 020006 00 00  HALOGEN FREE ALEV YAYAN FLAMMABLE
 001 057 010006 00 00    ALEV YAYMAYAN NON FLAMMABLE

6'lı SIVA ALTI W OTOMAT KUTUSU
 FLUSH-MOUNTED FUSE BOX, 6 FUSE

Ambalaj Şekli	Packing Type	Kutu - Box
Adet	Quantity	20
Ağırlık	Weight	9,88 / 9,00 / 9,54 kg
m ³	Volume	0,07207



001 057 000009 00 00 ALEV YAYAN FLAMMABLE
 001 057 020009 00 00  HALOGEN FREE ALEV YAYAN FLAMMABLE
 001 057 010009 00 00    ALEV YAYMAYAN NON FLAMMABLE

9'lu SIVA ALTI W OTOMAT KUTUSU
 FLUSH-MOUNTED FUSE BOX, 9 FUSE

Ambalaj Şekli	Packing Type	Kutu - Box
Adet	Quantity	20
Ağırlık	Weight	12,352 / 12,66 / 12,36 kg
m ³	Volume	0,09150



001 057 000012 00 00 ALEV YAYAN FLAMMABLE
 001 057 020012 00 00  HALOGEN FREE ALEV YAYAN FLAMMABLE
 001 057 010012 00 00    ALEV YAYMAYAN NON FLAMMABLE

12'li SIVA ALTI W OTOMAT KUTUSU
 FLUSH-MOUNTED FUSE BOX, 12 FUSE

Ambalaj Şekli	Packing Type	Kutu - Box
Adet	Quantity	10
Ağırlık	Weight	8,73 / 9,00 / 9,54 kg
m ³	Volume	0,07207



001 057 000018 00 00 ALEV YAYAN FLAMMABLE
 001 057 020018 00 00  HALOGEN FREE ALEV YAYAN FLAMMABLE
 001 057 010018 00 00    ALEV YAYMAYAN NON FLAMMABLE

18'li SIVA ALTI W OTOMAT KUTUSU
 FLUSH-MOUNTED FUSE BOX, 18 FUSE

Ambalaj Şekli	Packing Type	Kutu - Box
Adet	Quantity	10
Ağırlık	Weight	11,738 / 11,63 / 12,27 kg
m ³	Volume	0,07207



001 057 000024 00 00 ALEV YAYAN FLAMMABLE
 001 057 020024 00 00  HALOGEN FREE ALEV YAYAN FLAMMABLE
 001 057 010024 00 00    ALEV YAYMAYAN NON FLAMMABLE

24'lü SIVA ALTI W OTOMAT KUTUSU
 FLUSH-MOUNTED FUSE BOX, 24 FUSE

Ambalaj Şekli	Packing Type	Kutu - Box
Adet	Quantity	10
Ağırlık	Weight	6,941 / 6,79 / 7,22 kg
m ³	Volume	0,05507



001 057 000036 00 00 ALEV YAYAN FLAMMABLE
 001 057 020036 00 00  HALOGEN FREE ALEV YAYAN FLAMMABLE
 001 057 010036 00 00    ALEV YAYMAYAN NON FLAMMABLE

36'lü SIVA ALTI W OTOMAT KUTUSU
 FLUSH-MOUNTED FUSE BOX, 36 FUSE

Ambalaj Şekli	Packing Type	Kutu - Box
Adet	Quantity	5
Ağırlık	Weight	8,950 / 8,825 / 9,58 kg
m ³	Volume	0,07306

COMFORT W OTOMAT KUTULARI COMFORT FUSE BOXES



COMFORT MÜHÜRLÜ SİGORTA KUTULARI COMFORT SEALED FUSE BOX



001 057 200001 00 00

1'li SIVA ÜSTÜ
MÜHÜRLÜ SİGORTA KUTUSU
SURFACE-MOUNTED SEALED
FUSE BOX, 1 FUSE

Ambalaj Şekli	Packing Type	Kutu - Pack
Adet	Quantity	20
Ağırlık	Weight	1,42 kg
m ³	Volume	0,01096



001 057 200002 00 00

1-2'li SIVA ÜSTÜ
MÜHÜRLÜ SİGORTA KUTUSU
SURFACE-MOUNTED
FUSE BOX, 1-2 FUSES

Ambalaj Şekli	Packing Type	Kutu - Pack
Adet	Quantity	20
Ağırlık	Weight	1,75 kg
m ³	Volume	0,01412



001 057 200004 00 00

3-4'lü SIVA ÜSTÜ
MÜHÜRLÜ SİGORTA KUTUSU
SURFACE-MOUNTED SEALED
FUSE BOX, 3-4 FUSES

Ambalaj Şekli	Packing Type	Kutu - Pack
Adet	Quantity	10
Ağırlık	Weight	1,212 kg
m ³	Volume	0,01117

COMFORT MÜHÜRLÜ SİGORTA KUTULARI (ALEV YAYMAYAN) COMFORT SERIES SEALED FUSE BOXES (NON FLAMMABLE)



001 057 210001 00 00

1'li SIVA ÜSTÜ
MÜHÜRLÜ SİGORTA KUTUSU
SURFACE-MOUNTED SEALED
FUSE BOX, 1 FUSE

Ambalaj Şekli	Packing Type	Kutu - Pack
Adet	Quantity	20
Ağırlık	Weight	1,62 kg
m ³	Volume	0,01096



001 057 210002 00 00

1-2'li SIVA ÜSTÜ
MÜHÜRLÜ SİGORTA KUTUSU
SURFACE-MOUNTED SEALED
FUSE BOX, 1-2 FUSES

Ambalaj Şekli	Packing Type	Kutu - Pack
Adet	Quantity	20
Ağırlık	Weight	1,91 kg
m ³	Volume	0,01412



001 057 210004 00 00

3-4'lü SIVA ÜSTÜ
MÜHÜRLÜ SİGORTA KUTUSU
SURFACE-MOUNTED SEALED
FUSE BOX, 3-4 FUSES

Ambalaj Şekli	Packing Type	Kutu - Pack
Adet	Quantity	10
Ağırlık	Weight	1,275 kg
m ³	Volume	0,01117

COMFORT MÜHÜRLÜ SİGORTA KUTULARI HALOGEN FREE (ALEV YAYAN) MEKS SERIES USE BOXES HALOGEN FREE (FLAMMEBLE)



001 057 220001 00 00

1'li SIVA ÜSTÜ
MÜHÜRLÜ SİGORTA KUTUSU
SURFACE-MOUNTED SEALED
FUSE BOX, 1 FUSE

Ambalaj Şekli	Packing Type	Kutu - Pack
Adet	Quantity	20
Ağırlık	Weight	1,42 kg
m ³	Volume	0,01096



001 057 220002 00 00

1-2'li SIVA ÜSTÜ
MÜHÜRLÜ SİGORTA KUTUSU
SURFACE-MOUNTED SELAED
FUSE BOX, 1-2 FUSES

Ambalaj Şekli	Packing Type	Kutu - Pack
Adet	Quantity	20
Ağırlık	Weight	1,75 kg
m ³	Volume	0,01412



001 057 220004 00 00

3-4'lü SIVA ÜSTÜ
MÜHÜRLÜ SİGORTA KUTUSU
SURFACE-MOUNTED SEALED
FUSE BOX, 3-4 FUSES

Ambalaj Şekli	Packing Type	Kutu - Pack
Adet	Quantity	10
Ağırlık	Weight	0,94 kg
m ³	Volume	0,01117

COMFORT W OTOMAT ZAYIF AKIM KUTUSU

COMFORT FUSE and LOW-CURRENT BOXES



İKİSİ BİR ARADA

HEM SİGORTA KUTUSU HEM ZAYIF AKIM KUTUSU

İçerisinde Modem, Acces Point, Switch, TV Dağıtıcı ve cihazların enerji beslemesi için grup priz montajı yapılabilen zayıf akım kutuları ile elektrik ve data tesisatlarındaki karmaşıklığı minimize etmek, arıza tespitini hızlı bir şekilde çözüme kavuşturmak mümkündür.

TWO IN ONE

BOTH THE FUSE BOX and THE LOW CURRENT BOX

It is possible to minimize the complexity of electrical and data installations and solve the problem quickly with Modem, Access Point, Switch, TV Distributor and low current boxes which can be grouped for power supply of devices.

AKSESUAR ACCESSORY



001 057 001236 00 00

COMFORT ZAYIF
AKIM ÖRTME PARÇASI
COMFORT LOW

Ambalaj Şekli	Packing Type	Kutu - Pack
Adet	Quantity	50
Ağırlık	Weight	0,46 kg
m ³	Volume	0,001

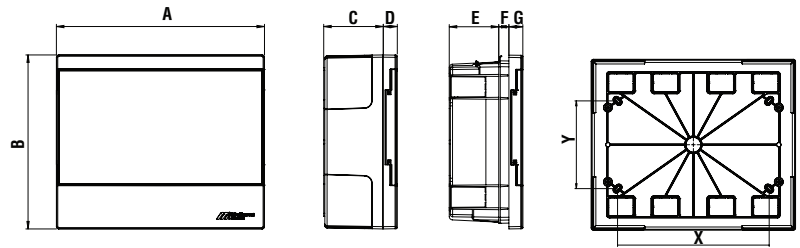

BOYUTLAR DIMENSION

SIVA ALTI FLUSH	A	B	E	F	G
ZAYIF AKIM 205x250 (İÇ ÖLÇÜ) LOW CURRENT (INNER DIMENSIONS)	275 mm	230 mm	65,5	13,5	18,5
ZAYIF AKIM 248x318 (İÇ ÖLÇÜ) LOW CURRENT (INNER DIMENSIONS)	275 mm	345 mm	65,5	13,5	18,5
12 SİGORTA +ZAYIF AKIM 12 FUSE + LOW CURRENT	275 mm	345 mm	65,5	13,5	18,5
24 SİGORTA +ZAYIF AKIM 24 FUSE + LOW CURRENT	460 mm	460 mm	65,5	13,5	18,5

SIVA ÜSTÜ SURFACE	A	B	C	D	X	Y
ZAYIF AKIM 205x250 (İÇ ÖLÇÜ) LOW CURRENT (INNER DIMENSIONS)	275 mm	230 mm	78,8	18,5	204	118
ZAYIF AKIM 248x318 (İÇ ÖLÇÜ) LOW CURRENT (INNER DIMENSIONS)	275 mm	345 mm	78,8	18,5	204	233
12 SİGORTA +ZAYIF AKIM 12 FUSE + LOW CURRENT	275 mm	345 mm	78,8	18,5	204	233
24 SİGORTA +ZAYIF AKIM 24 FUSE + LOW CURRENT	275 mm	460 mm	78,8	18,5	204	348

SIVA ÜSTÜ ZAYIF AKIM KUTULARI

SURFACE MOUNTED LOW CURRENT BOXES



001 057 101012 00 00	ALEV YAYAN FLAMMABLE
001 057 121012 00 00	HALOGEN FREE ALEV YAYAN FLAMMABLE
001 057 111012 00 00	ALEV YAYMAYAN NON FLAMMABLE



SIVA ÜSTÜ ZAYIF AKIM KUTUSU(225x270)
SURFACE-MOUNTED LOW CURRENT BOX (225x270)

Ambalaj Şekli	Packing Type	Kutu - Pack
Adet	Quantity	10
Ağırlık	Weight	8,21 kg
m ³	Volume	0,07207

001 057 101020 00 00	ALEV YAYAN FLAMMABLE
001 057 121020 00 00	HALOGEN FREE ALEV YAYAN FLAMMABLE
001 057 111020 00 00	ALEV YAYMAYAN NON FLAMMABLE



SIVA ÜSTÜ ZAYIF AKIM KUTUSU(270x340)
SURFACE-MOUNTED LOW CURRENT BOX (270x340)

Ambalaj Şekli	Packing Type	Kutu - Pack
Adet	Quantity	5
Ağırlık	Weight	6,94 kg
m ³	Volume	0,05507

001 057 101024 00 00	ALEV YAYAN FLAMMABLE
001 057 121024 00 00	HALOGEN FREE ALEV YAYAN FLAMMABLE
001 057 111024 00 00	ALEV YAYMAYAN NON FLAMMABLE



SIVA ÜSTÜ 12'li SİGORTA+ZAYIF AKIM KUTUSU
SURFACE-MOUNTED FUSE BOX (12)+LOW CURRENT BOX

Ambalaj Şekli	Packing Type	Kutu - Box
Adet	Quantity	5
Ağırlık	Weight	6,835 kg
m ³	Volume	0,05507

001 057 100018 00 00	ALEV YAYAN FLAMMABLE
001 057 120018 00 00	HALOGEN FREE ALEV YAYAN FLAMMABLE
001 057 110018 00 00	ALEV YAYMAYAN NON FLAMMABLE

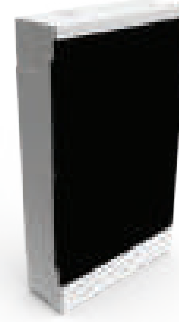

SIVA ÜSTÜ 24'lü SİGORTA+ZAYIF AKIM KUTUSU
SURFACE-MOUNTED FUSE BOX (24)+LOW CURRENT BOX

Ambalaj Şekli	Packing Type	Kutu - Box
Adet	Quantity	5
Ağırlık	Weight	9,39 kg
m ³	Volume	0,07306

SIVA ALTI ZAYIF AKIM KUTULARI

FLUSH MOUNTED LOW CURRENT BOXES



001 057 001012 00 00	ALEV YAYAN FLAMMABLE
001 057 021012 00 00	HALOGEN FREE ALEV YAYAN FLAMMABLE
001 057 011012 00 00	ALEV YAYMAYAN NON FLAMMABLE



SIVA ALTI ZAYIF AKIM KUTUSU(225x270)
FLUSH-MOUNTED LOW CURRENT BOX (225x270)

Ambalaj Şekli	Packing Type	Kutu - Box
Adet	Quantity	10
Ağırlık	Weight	8,445 kg
m ³	Volume	0,07207

001 057 001020 00 00	ALEV YAYAN FLAMMABLE
001 057 021020 00 00	HALOGEN FREE ALEV YAYAN FLAMMABLE
001 057 011020 00 00	ALEV YAYMAYAN NON FLAMMABLE



SIVA ALTI ZAYIF AKIM KUTUSU(270x340)
FLUSH-MOUNTED LOW CURRENT BOX (270x340)

Ambalaj Şekli	Packing Type	Kutu - Box
Adet	Quantity	5
Ağırlık	Weight	6,94 kg
m ³	Volume	0,05507

001 057 001024 00 00	ALEV YAYAN FLAMMABLE
001 057 021024 00 00	HALOGEN FREE ALEV YAYAN FLAMMABLE
001 057 011024 00 00	ALEV YAYMAYAN NON FLAMMABLE



SIVA ALTI 12'li SİGORTA+ZAYIF AKIM KUTUSU
FLUSH-MOUNTED FUSE BOX (12)+LOW CURRENT BOX

Ambalaj Şekli	Packing Type	Kutu - Box
Adet	Quantity	5
Ağırlık	Weight	6,835 kg
m ³	Volume	0,05507

001 057 001036 00 00	ALEV YAYAN FLAMMABLE
001 057 021036 00 00	HALOGEN FREE ALEV YAYAN FLAMMABLE
001 057 011036 00 00	ALEV YAYMAYAN NON FLAMMABLE



SIVA ALTI 24'lü SİGORTA+ZAYIF AKIM KUTUSU
FLUSH-MOUNTED FUSE BOX (24)+LOW CURRENT BOX

Ambalaj Şekli	Packing Type	Kutu - Box
Adet	Quantity	5
Ağırlık	Weight	9,39 kg
m ³	Volume	0,07306

MEKSBOX W OTOMAT KUTULARI

MEKSBOX FUSE BOXES

TERMİNAL KORUMA SEVİYESİ (Koruma Sınıfı) TERMINAL PROTECTION LEVEL (Protection Class)	IP30
KUTU TİPİ TYPES OF BOXES	DİKDÖRTGEN KUTULAR RECTANGULAR BOXES
TESİS SIRASINDAKİ SICAKLIK ARALIĞI THE TEMPERATURE RANGE DURING INSTALLATION	-25°C / +60°C
YALITIM DİRENÇİ INSULATION RESISTANCE	5MΩ 'un ÜZERİNDE OVER 5MΩ
YÜKSEK GERİLİME DAYANIM HIGH TENSILE RESISTANCE	3750 V AC (220V / 400V*50 Hz)

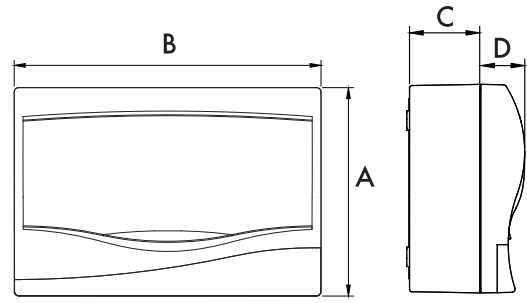
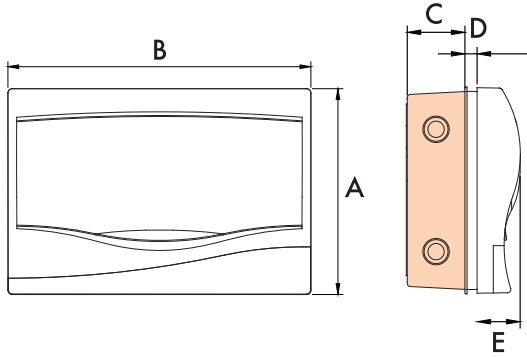

BOYUTLAR DIMENSION

SIVA ALTI FLUSH	A	B	C	D	E
2'li	142 mm	93 mm	53,5	11,5	40
4'lü	142 mm	138 mm	53,5	11,5	40
6'lı	142 mm	163 mm	53,5	11,5	40
9'lu	172 mm	217 mm	53,5	11,5	40
12'li	182 mm	272 mm	53,5	11,5	40
16'lı	272 mm	207 mm	53,5	11,5	40
24'lü	332 mm	272 mm	53,5	11,5	40
36'lı	482 mm	272 mm	53,5	11,5	40

SIVA ÜSTÜ SURFACE	A	B	C	D
2'li	149 mm	100 mm	65	40
4'lü	150 mm	150 mm	65	40
6'lı	150 mm	170 mm	65	40
9'lu	180 mm	225 mm	65	40
12'li	190 mm	280 mm	65	40
16'lı	290 mm	215 mm	65	40
24'lü	340 mm	280 mm	65	40
36'lı	490 mm	280 mm	65	40

TESİS VE UYGULAMA

Sağlam, yanmaz duvarda ve tavanda kullanıma uygundur. İnşaat sırasında ve inşaat işleminden sonra montaja elverişlidir.

Sert, yanabilir duvarlarda ve tavanlarda kullanıma uygundur.

Beton içerisi hariç tüm montaj tipleri için uygundur. Kutuların sıva üsü ve sıva altı tespiti son derece kolay yapabilecek şekilde tasarlanmıştır.

Kutular elektriksel korumayı sağlayacak şekilde tasarlanmıştır.

Kutuların giriş delikleri boru girişine uygundur.

Kutuların normal kullanım sürecinde oluşabilecek yaşlanma ve nemli şartlara karşı dayanıklılığı, sızdırmazlık ve aşınma testleri ve elektrik çarpmasına karşı koruma testleri, ısıya dayanıklılık testleri, mekanik dayanıklılık testleri ve olagan dışı ısıya karşı dayanıklılık testleri TS EN 60670-1/ARALIK 2015 standart kapsamında yapılan yeterlilik testleri ile doğrulanmıştır.

INSTALLATION AND APPLICATION

Fuse boxes are suitable for use on sound and fireproof walls and ceilings. The fuse boxes are suitable for installation during and after construction works.

Suitable for application on solid and combustible walls and ceilings.

Suitable for all installation types except for concrete embedded applications.

The fuse boxes are designed to be easily distinguished between flush-mounted and surface mounted type.

Fuse boxes are designed to provide electrical protection.

Inlet ports of the fuse boxes are compatible for pipe installation.

The resistance of the fuse boxes against ageing and humidity conditions that might occur during normal use, resistance of the metals used against oxidation are validated by means of permeability and abrasion tests, tests for resistance to temperature, mechanical endurance tests and extraordinary heat resistance to temperature, mechanical endurance tests and extraordinary heat resistance tests conducted under the scope of TS EN 60670-1/DECEMBER 2005 standard

COMFORT W OTOMAT KUTULARI

COMFORT FUSE BOXES



SIVA ÜSTÜ W OTOMAT KUTULARI

SURFACE MOUNTED FUSE BOXES

001 027 110002 00 00 ALEV YAYMAYAN
NON FLAMMABLE
001 027 100012 00 00 ALEV YAYAN
FLAMMABLE



1-2'li SIVA ÜSTÜ W OTOMAT KUTUSU
SURFACE-MOUNTED FUSE BOX, 1-2 FUSES

Ambalaj Şekli	Packing Type	Kutu - Box
Adet	Quantity	30
Ağırlık	Weight	9,933 / 9,459 kg
m ³	Volume	0,05700



001 027 110004 00 00 ALEV YAYMAYAN
NON FLAMMABLE
001 027 100004 00 00 ALEV YAYAN
FLAMMABLE

3-4'lü SIVA ÜSTÜ W OTOMAT KUTUSU
SURFACE-MOUNTED FUSE BOX, 3-4 FUSES

Ambalaj Şekli	Packing Type	Kutu - Box
Adet	Quantity	20
Ağırlık	Weight	8,274 / 7,880 kg
m ³	Volume	0,05400

001 027 110006 00 00 ALEV YAYMAYAN
NON FLAMMABLE
001 027 100006 00 00 ALEV YAYAN
FLAMMABLE



2-6'lı SIVA ÜSTÜ W OTOMAT KUTUSU
SURFACE-MOUNTED FUSE BOX, 2-6 FUSES

Ambalaj Şekli	Packing Type	Kutu - Box
Adet	Quantity	20
Ağırlık	Weight	10,143 / 9,660 kg
m ³	Volume	0,06400



001 027 110009 00 00 ALEV YAYMAYAN
NON FLAMMABLE
001 027 100009 00 00 ALEV YAYAN
FLAMMABLE

9'lu SIVA ÜSTÜ W OTOMAT KUTUSU
SURFACE-MOUNTED FUSE BOX, 9 FUSES

Ambalaj Şekli	Packing Type	Kutu - Box
Adet	Quantity	20
Ağırlık	Weight	14,065 / 13,396 kg
m ³	Volume	0,10000

001 027 110012 00 00 ALEV YAYMAYAN
NON FLAMMABLE
001 027 100012 00 00 ALEV YAYAN
FLAMMABLE



12'li SIVA ÜSTÜ W OTOMAT KUTUSU
SURFACE-MOUNTED FUSE BOX, 12 FUSES

Ambalaj Şekli	Packing Type	Kutu - Box
Adet	Quantity	10
Ağırlık	Weight	8,400 / 8,290 kg
m ³	Volume	0,06400



001 027 110016 00 00 ALEV YAYMAYAN
NON FLAMMABLE
001 027 100016 00 00 ALEV YAYAN
FLAMMABLE

16'li SIVA ÜSTÜ W OTOMAT KUTUSU
SURFACE-MOUNTED FUSE BOX, 16 FUSES

Ambalaj Şekli	Packing Type	Kutu - Box
Adet	Quantity	10
Ağırlık	Weight	11,015 / 10,490 kg
m ³	Volume	0,07300

001 027 110024 00 00 ALEV YAYMAYAN
NON FLAMMABLE
001 027 100024 00 00 ALEV YAYAN
FLAMMABLE



24'li SIVA ÜSTÜ W OTOMAT KUTUSU
SURFACE-MOUNTED FUSE BOX, 24 FUSES

Ambalaj Şekli	Packing Type	Kutu - Box
Adet	Quantity	5
Ağırlık	Weight	7,697 / 7,330 kg
m ³	Volume	0,05700



001 027 110036 00 00 ALEV YAYMAYAN
NON FLAMMABLE
001 027 100036 00 00 ALEV YAYAN
FLAMMABLE

36'lı SIVA ÜSTÜ W OTOMAT KUTUSU
SURFACE-MOUNTED FUSE BOX, 36 FUSES

Ambalaj Şekli	Packing Type	Kutu - Box
Adet	Quantity	5
Ağırlık	Weight	10,720 / 10,105 kg
m ³	Volume	0,07595

SIVA ALTI W OTOMAT KUTULARI

FLUSH MOUNTED FUSE BOXES

001 027 010002 00 00 ALEV YAYMAYAN
NON FLAMMABLE
001 027 000002 00 00 ALEV YAYAN
FLAMMABLE



1-2'li SIVA ALTI W OTOMAT KUTUSU
FLUSH-MOUNTED FUSE BOX, 1-2 FUSES

Ambalaj Şekli	Packing Type	Kutu - Box
Adet	Quantity	30
Ağırlık	Weight	9,398 / 8,949 kg
m ³	Volume	0,05700



001 027 010004 00 00 ALEV YAYMAYAN
NON FLAMMABLE
001 027 000004 00 00 ALEV YAYAN
FLAMMABLE

3-4'lü SIVA ALTI W OTOMAT KUTUSU
FLUSH-MOUNTED FUSE BOX, 3-4 FUSES

Ambalaj Şekli	Packing Type	Kutu - Box
Adet	Quantity	20
Ağırlık	Weight	7,880 / 7,506 kg
m ³	Volume	0,05400

COMFORT W OTOMAT KUTULARI COMFORT FUSE BOXES



001 027 010006 00 00    ALEV YAYMAYAN
NON FLAMMABLE
001 027 000006 00 00 ALEV YAYAN
FLAMMABLE

2-6'lı SIVA ALTI W OTOMAT KUTUSU
FLUSH-MOUNTED FUSE BOX, 2-6 FUSES



Ambalaj Şekli	Packing Type	Kutu - Box
Adet	Quantity	20
Ağırlık	Weight	9,550 / 9,096 kg
m ³	Volume	0,06400

001 027 010009 00 00    ALEV YAYMAYAN
NON FLAMMABLE
001 027 000009 00 00 ALEV YAYAN
FLAMMABLE

9'lu SIVA ALTI W OTOMAT KUTUSU
FLUSH-MOUNTED FUSE BOX, 9 FUSES



Ambalaj Şekli	Packing Type	Kutu - Box
Adet	Quantity	20
Ağırlık	Weight	13,582 / 12,936 kg
m ³	Volume	0,10000

001 027 010012 00 00    ALEV YAYMAYAN
NON FLAMMABLE
001 027 000012 00 00 ALEV YAYAN
FLAMMABLE

12'li SIVA ALTI W OTOMAT KUTUSU
FLUSH-MOUNTED FUSE BOX, 12 FUSES



Ambalaj Şekli	Packing Type	Kutu - Box
Adet	Quantity	10
Ağırlık	Weight	8,850 / 8,380 kg
m ³	Volume	0,06400

001 027 010016 00 00    ALEV YAYMAYAN
NON FLAMMABLE
001 027 000016 00 00 ALEV YAYAN
FLAMMABLE

16'li SIVA ALTI W OTOMAT KUTUSU
FLUSH-MOUNTED FUSE BOX, 16 FUSES



Ambalaj Şekli	Packing Type	Kutu - Box
Adet	Quantity	10
Ağırlık	Weight	10,238 / 9,750 kg
m ³	Volume	0,07300

001 027 010024 00 00    ALEV YAYMAYAN
NON FLAMMABLE
001 027 000024 00 00 ALEV YAYAN
FLAMMABLE

24'lu SIVA ALTI W OTOMAT KUTUSU
FLUSH-MOUNTED FUSE BOX, 24 FUSES



Ambalaj Şekli	Packing Type	Kutu - Box
Adet	Quantity	5
Ağırlık	Weight	7,534 / 7,175 kg
m ³	Volume	0,05700

001 027 010036 00 00    ALEV YAYMAYAN
NON FLAMMABLE
001 027 000036 00 00 ALEV YAYAN
FLAMMABLE

36'li SIVA ALTI W OTOMAT KUTUSU
FLUSH-MOUNTED FUSE BOX, 36 FUSES



Ambalaj Şekli	Packing Type	Kutu - Box
Adet	Quantity	5
Ağırlık	Weight	10,835 / 10,200 kg
m ³	Volume	0,07595

MEKS MÜHÜRLÜ SİGORTA KUTULARI HALOGEN FREE MEKS SERIES FUSE BOXES HALOGEN FREE



ALEV YAYMAYAN
NON FLAMMABLE
  001 027 210001 00 00
ALEV YAYAN
FLAMMABLE
001 027 200001 00 00

1'li SIVA ÜSTÜ
MÜHÜRLÜ SİGORTA KUTUSU
SURFACE-MOUNTED SEALED
FUSE BOX, 1 FUSE

Ambalaj Şekli	Packing Type	Kutu - Pack
Adet	Quantity	160
Ağırlık	Weight	10,208 / 9,728 kg
m ³	Volume	0,08000



ALEV YAYMAYAN
NON FLAMMABLE
  001 027 210002 00 00
ALEV YAYAN
FLAMMABLE
001 027 200002 00 00

1-2'li SIVA ÜSTÜ
MÜHÜRLÜ SİGORTA KUTUSU
SURFACE-MOUNTED SEALED
FUSE BOX, 1-2 FUSES

Ambalaj Şekli	Packing Type	Kutu - Pack
Adet	Quantity	80
Ağırlık	Weight	6,500 / 6,192 kg
m ³	Volume	0,04800



ALEV YAYMAYAN
NON FLAMMABLE
  001 027 210004 00 00
ALEV YAYAN
FLAMMABLE
001 027 200004 00 00

3-4'li SIVA ÜSTÜ
MÜHÜRLÜ SİGORTA KUTUSU
SURFACE-MOUNTED SEALED
FUSE BOX, 3-4 FUSES

Ambalaj Şekli	Packing Type	Kutu - Pack
Adet	Quantity	80
Ağırlık	Weight	8,936 / 8,512 kg
m ³	Volume	0,08800

TELEFON DAĞITIM KUTULARI VE AKSESUARLARI

TELEPHONE DISTRIBUTION BOXES (HUBS) AND ACCESSORIES



001 049 201020 00 00

ALEV YAYMAYAN
NON FLAMMABLE

001 049 001020 00 00

ALEV YAYAN
FLAMMABLE

TELEFON DAĞITIM KUTUSU, 10-20 (Plastik Kilitli)
TELEPHONE DISTRIBUTION BOX, 10-20 HUBS
(With Plastic Lock)

Ambalaj Şekli	Packing Type	Kutu - Box
Adet	Quantity	60
Ağırlık	Weight	20,502 kg
Hacim	Volume	0,13709



001 049 211020 00 00

ALEV YAYMAYAN
NON FLAMMABLE

001 049 011020 00 00

ALEV YAYAN
FLAMMABLE

TELEFON DAĞITIM KUTUSU, 10-20 (Kilitli)
TELEPHONE DISTRIBUTION BOX, 10-20 HUBS
(With Lock)

Ambalaj Şekli	Packing Type	Kutu - Box
Adet	Quantity	60
Ağırlık	Weight	21,198 kg
Hacim	Volume	0,13709



001 049 201050 00 00

ALEV YAYMAYAN
NON FLAMMABLE

001 049 001050 00 00

ALEV YAYAN
FLAMMABLE

TELEFON DAĞITIM KUTUSU, 10-50 (Plastik Kilitli)
TELEPHONE DISTRIBUTION BOX, 10-50 HUBS
(With Plastic Lock)

Ambalaj Şekli	Packing Type	Kutu - Box
Adet	Quantity	28
Ağırlık	Weight	18,029 kg
Hacim	Volume	0,13709



001 049 211050 00 00

ALEV YAYMAYAN
NON FLAMMABLE

001 049 011050 00 00

ALEV YAYAN
FLAMMABLE

TELEFON DAĞITIM KUTUSU, 10-50 (Kilitli)
TELEPHONE DISTRIBUTION BOX, 10-50 HUBS
(With Lock)

Ambalaj Şekli	Packing Type	Kutu - Box
Adet	Quantity	28
Ağırlık	Weight	18,620 kg
Hacim	Volume	0,13709



888 049 050002

TELEFON DAĞITIM MODÜLÜ (Kesmeli)
TELEPHONE DISTRIBUTION MODULE
(With Interrupt Feature)

Ambalaj Şekli	Packing Type	Kutu - Box
Adet	Quantity	400
Ağırlık	Weight	23,200 kg
Hacim	Volume	0,06200

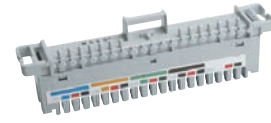

888 049 050001

TELEFON DAĞITIM MODÜLÜ (Kesmesiz)
10 PAIRS CONNECTION MODULE

Ambalaj Şekli	Packing Type	Kutu - Box
Adet	Quantity	400
Ağırlık	Weight	23,200 kg
Hacim	Volume	0,06200



888 049 050003

İRTİBATLAMA ALETİ
CONNECTION TOOL

Ambalaj Şekli	Packing Type	Kutu - Box
Adet	Quantity	100
Ağırlık	Weight	10,500 kg
Hacim	Volume	0,03480



888 049 050008

DATA KONNEKTÖRÜ Cat 6e (RJ 45) (8 Kontakt)
DATA CONNECTOR Cat 6e (Rj 45)(8 Contacts)

Ambalaj Şekli	Packing Type	Kutu - Box
Adet	Quantity	600
Ağırlık	Weight	8,94 kg
Hacim	Volume	0,06000



888 049 050009

DATA KONNEKTÖRÜ (RJ 11/12) (6Kontakt)
TELEPHONE CONNECTOR (Rj 11/12)(8 Contacts)

Ambalaj Şekli	Packing Type	Kutu - Box
Adet	Quantity	200
Ağırlık	Weight	1,34 kg
Hacim	Volume	0,00560

MOBİL BAĞLANTI ÇATISI

MODULE CONNECTION RACK



001 024 000001 00 00

1 MODÜL/RACK FOR 1 MODUL

Ambalaj Şekli	Packing Type	Kutu - Box
Adet	Quantity	1000
Ağırlık	Weight	25 kg
Hacim	Volume	0,05100



001 024 000002 00 00

2 MODÜL/RACK FOR 2 MODUL

Ambalaj Şekli	Packing Type	Kutu - Box
Adet	Quantity	500
Ağırlık	Weight	24 kg
Hacim	Volume	0,05100



001 024 000003 00 00

3 MODÜL/RACK FOR 3 MODUL

Ambalaj Şekli	Packing Type	Kutu - Box
Adet	Quantity	400
Ağırlık	Weight	27,6 kg
Hacim	Volume	0,05120



001 024 000004 00 00

4 MODÜL/RACK FOR 4 MODUL

Ambalaj Şekli	Packing Type	Kutu - Box
Adet	Quantity	300
Ağırlık	Weight	28,5 kg
Hacim	Volume	0,05130

001 024 000005 00 00

5 MODÜL/RACK FOR 5 MODUL

Ambalaj Şekli	Packing Type	Kutu - Box
Adet	Quantity	200
Ağırlık	Weight	22,94 kg
Hacim	Volume	0,05120

001 024 000010 00 00

10 MODÜL/RACK FOR 10 MODUL

Ambalaj Şekli	Packing Type	Kutu - Box
Adet	Quantity	100
Ağırlık	Weight	22,7 kg
Hacim	Volume	0,08600



Yüksek Kalite, Doğru Tercih
High Quality, Right Choice



SPİRALLER VE BORULAR

SPIRALS AND PIPES



HALOJEN FREE SPİRALLER HALOGEN FREE SPIRALS

ÇELİK SPİRALLER STEEL SPIRALS

PLASTİK SPİRALLER PVC INSULATED SPIRALS

PVC İZOLELİ SPİRALLER PLASTIC SPIRALS

HALOJEN FREE SİRALLER 320 N

HALOGEN FREE SPIRALS 320 N



	H.FREE ALEV YAYAN SİRALLER H.FREE FLAMMABLE SPIRALS	H.FREE ALEV YAYMAYAN SİRALLER H.FREE NON FLAMMABLE SPIRALS
BORU TİPİ TYPE OF THE PIPE	METALİK - OLMAYAN - OLUKLU NON METALLIC - CORRUGATED	METALİK - OLMAYAN - OLUKLU NON METALLIC - CORRUGATED
BAĞLANTI METODU CONNECTION METHOD	DİŞ ÇEKİLMEMİŞ NON THREADED	DİŞ ÇEKİLMEMİŞ NON THREADED
SIKIŞTIRMAYA KARŞI DAYANIKLILIK IMPACT RESISTANCE	HAFİF (320 N) ORTA (750 N) LOW (320 N) MEDIUM (750 N)	HAFİF (320 N) ORTA (750 N) LOW (320 N) MEDIUM (750 N)
DARBEYE KARŞI DAYANIKLILIK INSULATION RESISTANCE	ORTA (2 kg, 100mm) - 15°C'de MEDIUM (2kg, 100 mm) - 15°C	ORTA (2 kg, 100mm) - 15°C'de MEDIUM (2kg, 100 mm) - 15°C
EN KÜÇÜK SÜREKLİ UYGULAMA VE TESİSAT SICAKLIĞI MINIMUM CONTINUOUS APPLICATION AND INSTALLATION TEMPERATURE	-15°C	-15°C
EN BÜYÜK SÜREKLİ UYGULAMA VE TESİSAT SICAKLIĞI MINIMUM CONTINUOUS APPLICATION AND INSTALLATION TEMPERATURE	+60°C	+60°C
BÜKÜLMEMEYE KARŞI DAYANIKLILIK FLEXURAL STRENGTH	ESNEK - KENDİNİ TOPARLAYAN FLEXIBLE-SELF RECOVERING	ESNEK - KENDİNİ TOPARLAYAN FLEXIBLE-SELF RECOVERING
DİŞ ETKENLERE KARŞI DAYANIKLILIK RESISTANCE TO EXTERNAL IMPACTS	KATI YABANCI CİSİMLERİN GİRİŞİNE KARŞI KORUMALI PROTECTED AGAINST INGRESS OF SOLID FOREIGN MATERIALS	KATI YABANCI CİSİMLERİN GİRİŞİNE KARŞI KORUMALI PROTECTED AGAINST INGRESS OF SOLID FOREIGN MATERIALS
ALEV YAYILMASINA KARŞI DAYANIKLILIK RESISTANCE FLAME PROPAGATION	ALEV YAYAN FLAMMABLE	ALEV YAYMAYAN NON FLAMMABLE



HALOGEN FREE SİRAL ALEV YAYAN 320 N

HALOGEN FREE SPIRALS FLAMMABLE 320 N

KOD CODE	İÇ ÇAP INNER DIAMETER	DİŞ ÇAP OUTER DIAMETER	KUTU BOX	AĞIRLIK WEIGHT	HACİM VOLUME
001 020 140016 00 17	11,20 mm	15,70 mm	100m	2,8	0,041715
001 020 140020 00 17	14,40 mm	19,85 mm	100m	3,7	0,06
001 020 140025 00 17	19,10 mm	24,70 mm	50m	2,5	0,044435
001 020 140032 00 17	24,85 mm	31,60 mm	50m	3,45	0,064735
001 020 140040 00 17	-	-	25m	2,48	0,0695285
001 020 140050 00 17	-	-	25m	3,194	0,1078



HALOGEN FREE SİRAL KLAVUZ TELLİ ALEV YAYAN 320 N

HALOGEN FREE SPIRALS FLAMMABLE WITH GUIDE 320 N

KOD CODE	İÇ ÇAP INNER DIAMETER	DİŞ ÇAP OUTER DIAMETER	KUTU BOX	AĞIRLIK WEIGHT	HACİM VOLUME
001 020 141016 00 17	11,20 mm	15,70 mm	100m	3,1	0,04
001 020 141020 00 17	14,40 mm	19,85 mm	100m	4,1	0,06
001 020 141025 00 17	19,10 mm	24,70 mm	50m	2,71	0,045
001 020 141032 00 17	24,85 mm	31,60 mm	50m	3,68	0,065
001 020 141040 00 17	-	-	25m	2,78	0,07



HALOGEN FREE SİRAL ALEV YAYMAYAN 320 N

HALOGEN FREE SPIRALS NON FLAMMABLE 320 N

KOD CODE	İÇ ÇAP INNER DIAMETER	DİŞ ÇAP OUTER DIAMETER	KUTU BOX	AĞIRLIK WEIGHT	HACİM VOLUME
001 020 150016 00 17	11,20 mm	15,70 mm	100m	2,76	0,041715
001 020 150020 00 17	14,40 mm	19,85 mm	100m	3,7	0,058989
001 020 150025 00 17	19,10 mm	24,70 mm	50m	2,51	0,044435
001 020 150032 00 17	24,85 mm	31,60 mm	50m	3,43	0,064735
001 020 150040 00 17	-	-	25m	2,48	0,0695275
001 020 150050 00 17	-	-	25m	3,195	0,1078



HALOGEN FREE SİRAL KLAVUZ TELLİ ALEV YAYMAYAN 320 N

HALOGEN FREE SPIRALS NON FLAMMABLE WITH GUIDE 320 N

KOD CODE	İÇ ÇAP INNER DIAMETER	DİŞ ÇAP OUTER DIAMETER	KUTU BOX	AĞIRLIK WEIGHT	HACİM VOLUME
001 020 151016 00 17	11,20 mm	15,70 mm	100m	3,1	0,04
001 020 151020 00 17	14,40 mm	19,85 mm	100m	4,1	0,05899
001 020 151025 00 17	19,10 mm	24,70 mm	50m	2,711	0,045
001 020 151032 00 17	24,85 mm	31,60 mm	50m	3,68	0,065
001 020 151040 00 17	-	-	25m	2,58	0,07



HALOGEN FREE SİRALLER 750 N

HALOGEN FREE SPIRALS 750 N



HALOGEN FREE SİRAL ALEV YAYAN 750 N

HALOGEN FREE SPIRALS
FLAMMABLE 320 N

KOD CODE	İÇ ÇAP INNER DIAMETER	DIŞ ÇAP OUTER DIAMETER	KUTU BOX	AĞIRLIK WEIGHT	HACİM VOLUME
001 020 740020 00 17	14,40 mm	19,85 mm	100m	3,66	0,058989
001 020 740025 00 17	19,10 mm	24,70 mm	50m	2,511	0,044435
001 020 740032 00 17	24,85 mm	31,60 mm	50m	3,43	0,064735



HALOGEN FREE SİRAL KILAVUZ TELLİ ALEV YAYAN 750 N

HALOGEN FREE SPIRALS
FLAMMABLE WITH GUIDE 320 N

KOD CODE	İÇ ÇAP INNER DIAMETER	DIŞ ÇAP OUTER DIAMETER	KUTU BOX	AĞIRLIK WEIGHT	HACİM VOLUME
001 020 741020 00 17	14,40 mm	19,85 mm	100m	2,71	0,045
001 020 741025 00 17	19,10 mm	24,70 mm	50m	3,68	0,065
001 020 741032 00 17	24,85 mm	31,60 mm	50m	2,78	0,07



PVC ALEV YAYMAYAN SİRAL

PVC SPTRALS FLAME - PROPAGATING



HAFİF SERİ PVC SİRAL ALEV YAYMAYAN 320 N

LIGHT SERIES PVC SPIRAL
NON FLAMMABLE 320 N

KOD CODE	İÇ ÇAP INNER DIAMETER	DIŞ ÇAP OUTER DIAMETER	KUTU BOX	AĞIRLIK WEIGHT	HACİM VOLUME
001 020 010016 00 17	11,20 mm	15,70 mm	100m	4,5	0,07
001 020 010020 00 17	14,40 mm	19,85 mm	100m	6,18	0,08
001 020 010025 00 17	19,10 mm	24,70 mm	50m	4,08	0,07
001 020 010032 00 17	24,85 mm	31,60 mm	50m	5,195	0,1029



HAFİF SERİ PVC SİRAL ALEV YAYMAYAN 320 N KILAVUZ TELLİ

LIGHT SERIES PVC SPIRAL
NON FLAMMABLE WITH GUIDE 320 N

KOD CODE	İÇ ÇAP INNER DIAMETER	DIŞ ÇAP OUTER DIAMETER	KUTU BOX	AĞIRLIK WEIGHT	HACİM VOLUME
001 020 012016 00 17	11,20 mm	15,70 mm	100m	4,5	0,07
001 020 012020 00 17	14,40 mm	19,85 mm	100m	6,18	0,08
001 020 012025 00 17	19,10 mm	24,70 mm	50m	4,08	0,07
001 020 012032 00 17	24,85 mm	31,60 mm	50m	5,195	0,1029



AĞIR SERİ PVC SİRAL ALEV YAYMAYAN 750 N

HEAVY SERIES PVC SPIRAL
NON FLAMMABLE 750 N

KOD CODE	İÇ ÇAP INNER DIAMETER	DIŞ ÇAP OUTER DIAMETER	KUTU BOX	AĞIRLIK WEIGHT	HACİM VOLUME
001 020 000016 00 17	11,20 mm	15,85 mm	100m	4,5	0,07
001 020 000020 00 17	14,40 mm	19,85 mm	100m	6,2	0,08
001 020 000025 00 17	19,10 mm	24,70 mm	50m	4,1	0,07
001 020 000032 00 17	24,85 mm	31,60 mm	50m	5,195	0,105



AĞIR SERİ PVC SİRAL ALEV YAYMAYAN 750 N KILAVUZ TELLİ

HEAVY SERIES PVC SPIRAL
NON FLAMMABLE WITH GUIDE 750 N

KOD CODE	İÇ ÇAP INNER DIAMETER	DIŞ ÇAP OUTER DIAMETER	KUTU BOX	AĞIRLIK WEIGHT	HACİM VOLUME
001 020 100016 00 17	11,20 mm	15,85 mm	100m	4,86	0,07
001 020 100020 00 17	14,140 mm	19,85 mm	100m	6,6	0,08
001 020 100025 00 17	18,10 mm	24,80 mm	50m	4,3	0,07
001 020 100032 00 17	24,70 mm	31,80 mm	50m	5,395	0,105



ÇELİK SİRALLER

STEEL SPIRALS



	EKO İZOLELİ ÇELİK SİRALLER EKO INSULATED STEEL SPIRALS	MEKS İZOLELİ ÇELİK SİRALLER MEKS INSULATED STEEL SPIRALS
BORU TİPİ TYPE OF THE PIPE	METALİK - OLUKLU METALLIC - CORRUGATED	METALİK - OLUKLU METALLIC - CORRUGATED
BAĞLANTI METODU CONNECTION METHOD	DIŞ ÇEKİLMEMİŞ NON THREADED	DIŞ ÇEKİLMEMİŞ NON THREADED
SIKIŞTIRMAYA KARŞI DAYANIKLILIK IMPACT RESISTANCE	HAFİF (320 N) LOW (320 N)	HAFİF (320 N) LOW (320 N)
DARBEYE KARŞI DAYANIKLILIK INSULATION RESISTANCE	HAFİF (1 kg, 100mm) LOW (1 kg, 100 mm)	HAFİF (1 kg, 100mm) LOW (1 kg, 100 mm)
EN KÜÇÜK SÜREKLİ UYGULAMA VE TESİSAT SICAKLIĞI MINIMUM CONTINUOUS APPLICATION AND INSTALLATION TEMPERATURE	-15°C	-15°C
EN BÜYÜK SÜREKLİ UYGULAMA VE TESİSAT SICAKLIĞI MINIMUM CONTINUOUS APPLICATION AND INSTALLATION TEMPERATURE	+60	+60
BÜKÜLMEME KARŞI DAYANIKLILIK FLEXURAL STRENGTH	ESNEK FLEXIBLE	ESNEK FLEXIBLE
DIŞ ETKENLERE KARŞI DAYANIKLILIK RESISTANCE TO EXTERNAL IMPACTS	KATI YABANCI CİSİMLERİN GİRİŞİNE KARŞI KORUMALI PROTECTED AGAINST INGRESS OF SOLID FOREIGN MATERIALS	KATI YABANCI CİSİMLERİN GİRİŞİNE KARŞI KORUMALI PROTECTED AGAINST INGRESS OF SOLID FOREIGN MATERIALS
ALEV YAYILMASINA KARŞI DAYANIKLILIK RESISTANCE FLAME PROPAGATION	ALEV YAYMAYAN NON-FLAMMABLE	ALEV YAYMAYAN NON-FLAMMABLE



EKO SERİSİ ÇELİK SİRALLER

ECO SERIES STEEL SPIRALS

KOD CODE	İÇ ÇAP INNER DIAMETER	DIŞ ÇAP OUTER DIAMETER	KUTU BOX	AĞIRLIK WEIGHT	HACİM VOLUME
001 054 150009 00 66	9 mm	12,10 mm	50	2,5	0,012
001 054 150011 00 66	11 mm	14,10 mm	50	3,35	0,018
001 054 150014 00 66	14 mm	17,10 mm	50	4,35	0,0215
001 054 150016 00 66	16 mm	19,10 mm	50	4,6	0,0265
001 054 150018 00 66	18 mm	21,10 mm	50	5,1	0,03
001 054 150021 00 66	21 mm	24,10 mm	50	6,25	0,034
001 054 150026 00 66	26 mm	29,10 mm	25	4	0,03425
001 054 150029 00 66	29 mm	32,10 mm	25	4,875	0,0355
001 054 150032 00 66	32 mm	35,10 mm	25	5,05	0,0375
001 054 150037 00 66	37 mm	41,10 mm	25	5,75	0,05075
001 054 150042 00 66	42 mm	45,10 mm	25	6,875	0,06425
001 054 150050 00 66	50 mm	53,10 mm	25	8,875	0,09
001 054 150063 00 66	63 mm	66,10 mm	15	6,975	0,08325



EKO SERİSİ ÇELİK SİRALLER KLAUZ TELLİ

ECO SERIES STEEL SPIRALS WITH GUIDE

KOD CODE	İÇ ÇAP INNER DIAMETER	DIŞ ÇAP OUTER DIAMETER	KUTU BOX	AĞIRLIK WEIGHT	HACİM VOLUME
001 054 221011 00 66	11 mm	14,10 mm	50	4	0,018
001 054 221014 00 66	14 mm	17,10 mm	50	4,4	0,0245
001 054 221016 00 66	16 mm	19,10 mm	50	5,3	0,0265
001 054 221018 00 66	18 mm	21,10 mm	50	6,1	0,034279
001 054 221021 00 66	21 mm	24,10 mm	50	7,35	0,034
001 054 221026 00 66	26 mm	29,10 mm	25	4,075	0,03425
001 054 221029 00 66	29 mm	32,10 mm	25	4,975	0,0355
001 054 221032 00 66	32 mm	35,10 mm	25	5,15	0,0375
001 054 221037 00 66	37 mm	41,10 mm	25	5,85	0,05075
001 054 221042 00 66	42 mm	45,10 mm	25	6,775	0,06425
001 054 221050 00 66	50 mm	53,10 mm	25	8,975	0,09
001 054 221063 00 66	63 mm	66,10 mm	15	7,035	0,08325



MEKS SERİSİ ÇELİK SİRALLER

MEKS SERIES STEEL SPIRALS

KOD CODE	İÇ ÇAP INNER DIAMETER	DIŞ ÇAP OUTER DIAMETER	KUTU BOX	AĞIRLIK WEIGHT	HACİM VOLUME
001 054 120009 00 66	9 mm	12,10 mm	50	2,5	0,012
001 054 120011 00 66	11 mm	14,10 mm	50	3,35	0,018
001 054 120014 00 66	14 mm	17,10 mm	50	4,35	0,0215
001 054 120016 00 66	16 mm	19,10 mm	50	4,6	0,0265
001 054 120018 00 66	18 mm	21,10 mm	50	5,1	0,03
001 054 120021 00 66	21 mm	24,10 mm	50	6,25	0,034
001 054 120026 00 66	26 mm	29,10 mm	25	4	0,03425
001 054 120029 00 66	29 mm	32,10 mm	25	4,875	0,0355
001 054 120032 00 66	32 mm	35,10 mm	25	5,05	0,0375
001 054 120037 00 66	37 mm	41,10 mm	25	5,75	0,05075
001 054 120042 00 66	42 mm	45,10 mm	25	6,875	0,06425
001 054 120050 00 66	50 mm	53,10 mm	25	8,875	0,09
001 054 120063 00 66	63 mm	66,10 mm	15	6,975	0,08325



MEKS SERİSİ ÇELİK SİRALLER KLAUZ TELLİ

MEKS SERIES STEEL SPIRALS WITH GUIDE

KOD CODE	İÇ ÇAP INNER DIAMETER	DIŞ ÇAP OUTER DIAMETER	KUTU BOX	AĞIRLIK WEIGHT	HACİM VOLUME
001 054 121011 00 66	11 mm	14,10 mm	50	4	0,018
001 054 121014 00 66	14 mm	17,10 mm	50	4,4	0,0215
001 054 121016 00 66	16 mm	19,10 mm	50	5,3	0,0265
001 054 121018 00 66	18 mm	21,10 mm	50	6,1	0,03
001 054 121021 00 66	21 mm	24,10 mm	50	7,35	0,034
001 054 121026 00 66	26 mm	29,10 mm	25	4,075	0,03425
001 054 121029 00 66	29 mm	32,10 mm	25	4,975	0,0355
001 054 121032 00 66	32 mm	35,10 mm	25	5,15	0,0375
001 054 121037 00 66	37 mm	41,10 mm	25	5,85	0,05075
001 054 121042 00 66	42 mm	45,10 mm	25	6,775	0,06425
001 054 121050 00 66	50 mm	53,10 mm	25	8,975	0,09
001 054 121063 00 66	63 mm	66,10 mm	15	7,035	0,08325

PVC İZOLELİ SİRALLER

PVC INSULATED SPIRALS



BORU TİPİ TYPE OF THE PIPE	EKO İZOLELİ ÇELİK SİRALLER EKO INSULATED STEEL SPIRALS	MEKS İZOLELİ ÇELİK SİRALLER MEKS INSULATED STEEL SPIRALS
	BAĞLANTI METODU CONNECTION METHOD	KOMPOZİT - OLUKLU COMPOSITE - CORRUGATED
BAĞLANTI METODU CONNECTION METHOD	DIŞ ÇEKİLMEMİŞ NON THREADED	DIŞ ÇEKİLMEMİŞ NON THREADED
SIKİŞTIRMAYA KARŞI DAYANIKLILIK IMPACT RESISTANCE	HAFİF (320 N) LOW (320 N)	HAFİF (320 N) LOW (320 N)
DARBEME KARŞI DAYANIKLILIK INSULATION RESISTANCE	HAFİF (1 kg, 100mm) LOW (1 kg, 100 mm)	HAFİF (1 kg, 100mm) LOW (1 kg, 100 mm)
EN KÜÇÜK SÜREKLİ UYGULAMA VE TESİSAT SICAKLIĞI MINIMUM CONTINUOUS APPLICATION AND INSTALLATION TEMPERATURE	-15°C	-15°C
EN BÜYÜK SÜREKLİ UYGULAMA VE TESİSAT SICAKLIĞI MINIMUM CONTINUOUS APPLICATION AND INSTALLATION TEMPERATURE	+60	+60
BÜKÜLMEYE KARŞI DAYANIKLILIK FLEXURAL STRENGTH	ESNEK FLEXIBLE	ESNEK FLEXIBLE
DIŞ ETKENLERE KARŞI DAYANIKLILIK RESISTANCE TO EXTERNAL IMPACTS	KATI YABANCI CİSİMLERİN GİRİŞİNE KARŞI KORUMALI PROTECTED AGAINST INGRESS OF SOLID FOREIGN MATERIALS	KATI YABANCI CİSİMLERİN GİRİŞİNE KARŞI KORUMALI PROTECTED AGAINST INGRESS OF SOLID FOREIGN MATERIALS
ALEV YAYILMASINA KARŞI DAYANIKLILIK RESISTANCE FLAME PROPAGATION	ALEV YAYMAYAN NON-FLAMMABLE	ALEV YAYMAYAN NON-FLAMMABLE



EKO SERİSİ İZOLELİ ÇELİK SİRALLER

ECO SERIES STEEL SPIRALS

KOD CODE	İÇ ÇAP INNER DIAMETER	DIŞ ÇAP OUTER DIAMETER	KUTU BOX	AĞIRLIK WEIGHT	HACİM VOLUME
001 054 160009 00 11	9 mm	13,20 mm	50	5,05	0,015
001 054 160011 00 11	11 mm	15,20 mm	50	5,5	0,0215
001 054 160014 00 11	14 mm	18,40 mm	50	6,35	0,0305
001 054 160016 00 11	16 mm	20,40 mm	50	7,15	0,031
001 054 160018 00 11	18 mm	22,40 mm	50	7,8	0,0375
001 054 160021 00 11	21 mm	25,40 mm	50	10,1	0,042
001 054 160026 00 11	26 mm	30,40 mm	25	5,125	0,0325
001 054 160029 00 11	29 mm	33,40 mm	25	8,075	0,0425
001 054 160032 00 11	32 mm	36,40 mm	25	7,725	0,0455
001 054 160037 00 11	37 mm	42,40 mm	25	9,025	0,06475
001 054 160042 00 11	42 mm	46,40 mm	25	11,575	0,08075
001 054 160050 00 11	50 mm	54,40 mm	25	12,575	0,09875
001 054 160063 00 11	63 mm	66,10 mm	15	10,125	0,12255



EKO SERİSİ İZOLELİ ÇELİK SİRALLER KILAVUZ TELLİ

EKO SERIES INSULATED STEEL SPIRALS WITH GUIDE

KOD CODE	İÇ ÇAP INNER DIAMETER	DIŞ ÇAP OUTER DIAMETER	KUTU BOX	AĞIRLIK WEIGHT	HACİM VOLUME
001 054 231011 00 11	11 mm	15,20 mm	50	5,3	0,0215
001 054 231014 00 11	14 mm	18,40 mm	50	6,5	0,0245
001 054 231016 00 11	16 mm	20,40 mm	50	7,95	0,031
001 054 231018 00 11	18 mm	22,40 mm	50	8,65	0,034279
001 054 231021 00 11	21 mm	25,40 mm	50	9,85	0,042
001 054 231026 00 11	26 mm	30,40 mm	25	5,25	0,0325
001 054 231029 00 11	29 mm	33,40 mm	25	8,175	0,0425
001 054 231032 00 11	32 mm	36,40 mm	25	7,825	0,0455
001 054 231037 00 11	37 mm	42,40 mm	25	9,125	0,06475
001 054 231042 00 11	42 mm	46,40 mm	25	11,675	0,08075
001 054 231050 00 11	50 mm	54,40 mm	25	12,675	0,09875
001 054 231063 00 11	63 mm	66,10 mm	15	10,185	0,12255



MEKS SERİSİ İZOLELİ ÇELİK SİRALLER

MEKS SERIES STEEL SPIRALS

KOD CODE	İÇ ÇAP INNER DIAMETER	DIŞ ÇAP OUTER DIAMETER	KUTU BOX	AĞIRLIK WEIGHT	HACİM VOLUME
001 054 130009 00 11	9 mm	13,20 mm	50	5,05	0,015
001 054 130011 00 11	11 mm	15,20 mm	50	2,75	0,01075
001 054 130014 00 11	14 mm	18,40 mm	50	3,175	0,01225
001 054 130016 00 11	16 mm	20,40 mm	50	3,575	0,0155
001 054 130018 00 11	18 mm	22,40 mm	50	3,9	0,0171395
001 054 130026 00 11	26 mm	30,40 mm	25	5,125	0,0325
001 054 130029 00 11	29 mm	33,40 mm	25	8,075	0,0425
001 054 130032 00 11	32 mm	36,40 mm	25	7,725	0,0455
001 054 130037 00 11	37 mm	42,40 mm	25	9,025	0,06475
001 054 130042 00 11	42 mm	46,40 mm	25	11,575	0,08075
001 054 130050 00 11	50 mm	54,40 mm	25	12,575	0,09875
001 054 130063 00 11	63 mm	67,20 mm	15	10,125	0,12255



MEKS SERİSİ İZOLELİ ÇELİK SİRALLER KILAVUZ TELLİ

MEKS SERIES INSULATED STEEL SPIRALS WITH GUIDE

KOD CODE	İÇ ÇAP INNER DIAMETER	DIŞ ÇAP OUTER DIAMETER	KUTU BOX	AĞIRLIK WEIGHT	HACİM VOLUME
001 054 140011 00 11	11 mm	15,20 mm	50	5,3	0,0215
001 054 140014 00 11	14 mm	18,40 mm	50	6,5	0,0245
001 054 140016 00 11	16 mm	20,40 mm	50	7,95	0,031
001 054 140018 00 11	18 mm	22,40 mm	50	8,65	0,034279
001 054 140026 00 11	26 mm	30,40 mm	25	5,7	0,0325
001 054 140029 00 11	29 mm	33,40 mm	25	8,175	0,0425
001 054 140032 00 11	32 mm	36,40 mm	25	7,825	0,0455
001 054 140037 00 11	37 mm	42,40 mm	25	9,125	0,06475
001 054 140042 00 11	42 mm	46,40 mm	25	11,675	0,08075
001 054 140050 00 11	50 mm	54,40 mm	25	12,675	0,09875
001 054 140063 00 11	63 mm	67,20 mm	15	10,185	0,12255

PLASTİK SİRALLER

PLASTIC SPIRALS



Düzenin En Esnek Yolu
Düzenin En Esnek Yolu

BORU TİPİ TYPE OF THE PIPE	METALİK OLMAYAN - OLUKLU NON METALLIC - CORRUGATED
BAĞLANTI METODU CONNECTION METHOD	DIŞ ÇEKİLMEMİŞ NON THREADED
DARBEYE KARŞI DAYANIKLILIK INSULATION RESISTANCE	HAFİF (1 kg, 100mm) LOW (1 kg, 100 mm)
EN KÜÇÜK SÜREKLİ UYGULAMA VE TESİSAT SICAKLIĞI MINIMUM CONTINUOUS APPLICATION AND INSTALLATION TEMPERATURE	-15°C
EN BÜYÜK SÜREKLİ UYGULAMA VE TESİSAT SICAKLIĞI MAXIMUM CONTINUOUS APPLICATION AND INSTALLATION TEMPERATURE	+60
BÜKÜLMEMEYE KARŞI DAYANIKLILIK FLEXURAL STRENGTH	ESNEK FLEXIBLE
DIŞ ETKENLERE KARŞI DAYANIKLILIK RESISTANCE TO EXTERNAL IMPACTS	KATI YABANCI CİSİMLERİN GİRİŞİNE KARŞI KORUMALI PROTECTED AGAINST INGRESS OF SOLID FOREIGN MATERIALS
ALEV YAYILMASINA KARŞI DAYANIKLILIK RESISTANCE FLAME PROPAGATION	ALEV YAYAN FLAMMABLE



**MEKS SERİSİ
PLASTİK SİRALLER SİYAH**
MEKS SERIES PLASTIC
SPIRAL PIPES (BLACK)

KOD CODE	İÇ ÇAP INNER DIAMETER	DIŞ ÇAP OUTER DIAMETER	KUTU BOX	AĞIRLIK WEIGHT	HACİM VOLUME
001 020 400012 00 11	12,30 mm	15,90 mm	100m	3,1	0,06
001 020 400014 00 11	15,25 mm	18,75 mm	100m	3,1	0,06
001 020 400016 00 11	15,70 mm	19,00 mm	100m	3	0,057
001 020 400018 00 11	19,60 mm	24,03 mm	100m	4,8	0,1
001 020 400020 00 11	19,60 mm	24,03 mm	100m	4,8	0,09823
001 020 400026 00 11	26,15 mm	30,75 mm	50m	3,2	0,08
001 020 400032 00 11	29,10 mm	34,30 mm	50m	3,85	0,095
001 020 400040 00 11	36,20 mm	42,20 mm	25m	2,575	0,0695285
001 020 400050 00 11	48,50 mm	54,50 mm	25m	3,35	0,1125



**MEKS SERİSİ
PLASTİK SİRALLER SİYAH TELLİ**
MEKS SERIES PLASTIC SPIRAL
PIPES WITH GUIDE WIRE (BLACK)

KOD CODE	İÇ ÇAP INNER DIAMETER	DIŞ ÇAP OUTER DIAMETER	KUTU BOX	AĞIRLIK WEIGHT	HACİM VOLUME
001 020 410014 00 11	15,25 mm	18,75 mm	100m	3,5	0,057
001 020 410016 00 11	15,70 mm	19,00 mm	100m	3,4	0,057
001 020 410018 00 11	19,60 mm	24,03 mm	100m	5,2	0,09823
001 020 410020 00 11	19,60 mm	24,03 mm	100m	5,2	0,09823
001 020 410026 00 11	26,15 mm	30,75 mm	50m	3,4	0,080725
001 020 410032 00 11	29,10 mm	34,30 mm	50m	4,05	0,09295
001 020 410040 00 11	36,20 mm	42,20 mm	25m	2,675	0,0695275



**RENKLİ
PLASTİK SİRALLER**
MEKS SERIES PLASTIC
SPIRAL PIPES

KOD CODE	İÇ ÇAP INNER DIAMETER	DIŞ ÇAP OUTER DIAMETER	KUTU BOX	AĞIRLIK WEIGHT	HACİM VOLUME
001 020 400014 00 XX	15,25 mm	18,75 mm	100m	2,9	0,06
001 020 400016 00 XX	15,70 mm	19,00 mm	100m	2,8465	0,057
001 020 400018 00 XX	19,60 mm	24,03 mm	100m	4,5	0,09823
001 020 400020 00 XX	19,60 mm	24,03 mm	100m	4,5	0,09823
001 020 400026 00 XX	26,15 mm	30,75 mm	50m	3,05	0,080725
001 020 400032 00 XX	29,10 mm	34,30 mm	50m	3,594	0,095
001 020 400040 00 XX	36,20 mm	42,20 mm	25m	2,33	0,0695275
001 020 400050 00 XX	48,50 m	54,50 mm	25m	2,968	0,1125





ALEV YAYMAYAN POLİPROPİLEN SİRAL BORU

NON-FLAMMABLE POLYPROPYLENE SPIRAL PIPE

KOD CODE	ÜRÜN TANIMI DESCRIPTION	İÇ ÇAP INNER DIAMETER	DIŞ ÇAP OUTER DIAMETER	KUTU BOX	KOLİ PARCEL
001 020 160007 00 XX	MUT/PA6-7 / PSR7	7,00 mm	10,10 mm	10,10 mm	100 mt
001 020 160009 00 XX	MUT/PA6-8,5	8,40 mm	12,05 mm	12,05 mm	100 mt
001 020 160010 00 XX	MUT/PA6-10 / PSR9	10,20 mm	13,10 mm	13,10 mm	100 mt
001 020 16 0012 00 XX	MUT/PA6-12 / PSR11	12,30 mm	15,90 mm	15,90 mm	50 mt
001 020 160014 00 XX	MUT/PA6-14 / PSR13,5	14,10 mm	18,35 mm	18,35 mm	50 mt
001 020 160017 00 XX	MUT/PA6-17 / PSR16	17,00 mm	21,45 mm	21,45 mm	50 mt
001 020 160019 00 XX	MUT/PA6-19	19,00 mm	24,25 mm	24,25 mm	50 mt
001 020 160023 00 XX	MUT/PA6-23 / PSR21	23,25 mm	28,50 mm	28,50 mm	50 mt
001 020 160026 00 XX	MUT/PA6-26	26,20 mm	31,30 mm	31,30 mm	25 mt
001 020 160029 00 XX	MUT/PA6-29 / PSR29	29,10 mm	34,30 mm	34,30 mm	25 mt
001 020 160036 00 XX	MUT/PA6-36 / PSR36	36,20 mm	42,20 mm	42,20 mm	25 mt
001 020 160048 00 XX	MUT/PA6-48 / PSR48	48,50 mm	54,50 mm	54,50 mm	25 mt

KORUGE BORULAR 250N CORRUGATED PIPES 250N

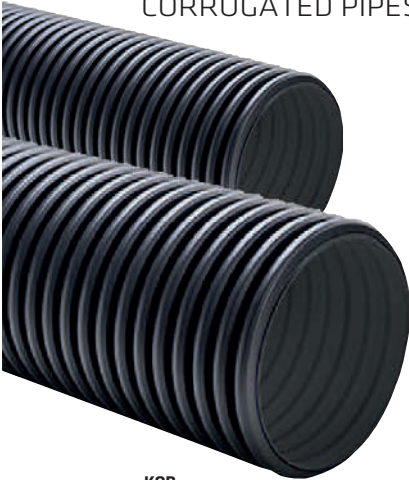

KOD CODE	AÇIKLAMA EXPLANATION	İÇ ÇAP INNER DIAMETER	DIŞ ÇAP OUTER DIAMETER	KUTU BOX	AĞIRLIK WEIGHT	HACİM VOLUME
096 045 150050	50 Ø KORUGE KANGAL BORU/CORRUGATED COIL PIPE	50 mm	43 mm	100m	22 kg	0,67
096 045 150060	63 Ø KORUGE KANGAL BORU/CORRUGATED COIL PIPE	63 mm	54 mm	100m	25 kg	1,04
096 045 150075	75 Ø KORUGE KANGAL BORU/CORRUGATED COIL PIPE	64 mm	75 mm	100m	30 kg	2,43
096 045 150100	100 Ø KORUGE BOY BORU(6MT)/ CORRUGATED LENGTH PIPE	85 mm	100 mm	6 mt boy	2,5 kg	0,072
096 045 150115	115 Ø KORUGE BOY BORU(6MT)/ CORRUGATED LENGTH PIPE	100 mm	115 mm	6 mt boy	3,0 kg	0,10
096 045 150004	50 Ø MANŞON	50,50 mm	52,00 mm	1	200 gr	0,0028
096 045 150003	75 Ø MANŞON	75,50 mm	76,00 mm	1	50 gr	0,0007
096 045 150002	100 Ø MANŞON	100,50 mm	102,00 mm	1	110 gr	0,0022
096 045 150001	115 Ø MANŞON	115,50 mm	117,00 mm	1	233 gr	0,0034

LOGAR KUTUSU MANHOLE BOX

KOD CODE	AÇIKLAMA EXPLANATION	KUTU BOX	AĞIRLIK WEIGHT	HACİM VOLUME
074 048 622020	20X20 LOGAR KUTUSU TAKIMI	20	1,06	0,06
074 048 623030	30X30 LOGAR KUTUSU TAKIMI	12	2,91	0,06
074 048 624040	40X40 LOGAR KUTUSU TAKIMI	4	5,87	0,02
074 048 625555	55X55 LOGAR KUTUSU TAKIMI	2	9,55	0,009

Esnek Bağlantı Flexible Connection
Yer Tasarrufu Space Saving
Dayanıklılık Durability

Esneklekle Bağlanın
Connecting with Flexibility.

SİRALLI ENERJİ KABLolarI H07V-U (NYA) KABLolar
SPIRALS ENERGY CABLES H07V-U (NYA) ENERGY CABLES

KOD CODE	KABLO KESİTİ CABLE DIMENSION	SİRALLI ÖZELLİK SPIRAL SPECIFICATION	SİRALLI ÇAP SPIRAL DIAMETER
122 050 215014	2x1.5 mm	HF-PE	14 mm
122 050 315014	3x1.5 mm	HF-PE	14 mm
122 050 415016	4x1.5 mm	HF-PE	16 mm
122 050 515020	5x1.5 mm	HF-PE	20 mm
122 050 225014	2x2.5 mm	HF-PE	14 mm
122 050 325016	3x2.5 mm	HF-PE	16 mm
122 050 425020	4x2.5 mm	HF-PE	20 mm
122 050 525025	5x2.5 mm	HF-PE	25 mm

**HALOGEN FREE
SİRALLI ENERJİ KABLolarI H07V-U (NYA) KABLolar**
SPIRALS ENERGY CABLES H07V-U (NYA) ENERGY CABLES

KOD CODE	KABLO KESİTİ CABLE DIMENSION	SİRALLI ÖZELLİK SPIRAL SPECIFICATION	SİRALLI ÇAP SPIRAL DIAMETER
122 051 215014	2x1.5 mm	HF-PE	14 mm
122 051 315014	3x1.5 mm	HF-PE	14 mm
122 051 415016	4x1.5 mm	HF-PE	16 mm
122 051 515020	5x1.5 mm	HF-PE	20 mm
122 051 225014	2x2.5 mm	HF-PE	14 mm
122 051 325016	3x2.5 mm	HF-PE	16 mm
122 051 425020	4x2.5 mm	HF-PE	20 mm
122 051 525025	5x2.5 mm	HF-PE	25 mm

SİRALLI ZAYIF AKIM DATA KABLolarI
SPIRALS LOW CURRENT DATA CABLES

KOD CODE	KABLO KESİTİ CABLE DIMENSION	SİRALLI ÖZELLİK SPIRAL SPECIFICATION	SİRALLI ÇAP SPIRAL DIAMETER
122 052 100516	U/UTP CAT5e	HF-PE	16 mm
122 052 100616	U/UTP CAT5e	HF-PE	16 mm

SİRALLI ZAYIF AKIM KOAKSİYEL KABLolarI
SPIRALS LOW CURRENT TV CABLES

KOD CODE	KABLO KESİTİ CABLE DIMENSION	SİRALLI ÖZELLİK SPIRAL SPECIFICATION	SİRALLI ÇAP SPIRAL DIAMETER
122 052 100214	RG 59/U2 (cu/AL)	HF-PE	14 mm
122 052 200416	RG 6/U4 (cu/AL)	HF-PE	16 mm
122 052 200616	RG 6/U6 (cu/AL)	HF-PE	16 mm

SİRALLI ZAYIF AKIM CCTV KAMERA KABLolarI
SPIRALS LOW CURRENT CCTV CAMERA CABLES

KOD CODE	KABLO KESİTİ CABLE DIMENSION	SİRALLI ÖZELLİK SPIRAL SPECIFICATION	SİRALLI ÇAP SPIRAL DIAMETER
122 052 301214	CCTV 1+2 (2x0.22 mm)	HF-PE	14 mm
122 052 301416	CCTV 1+4 (2x0.22 mm)	HF-PE	16 mm

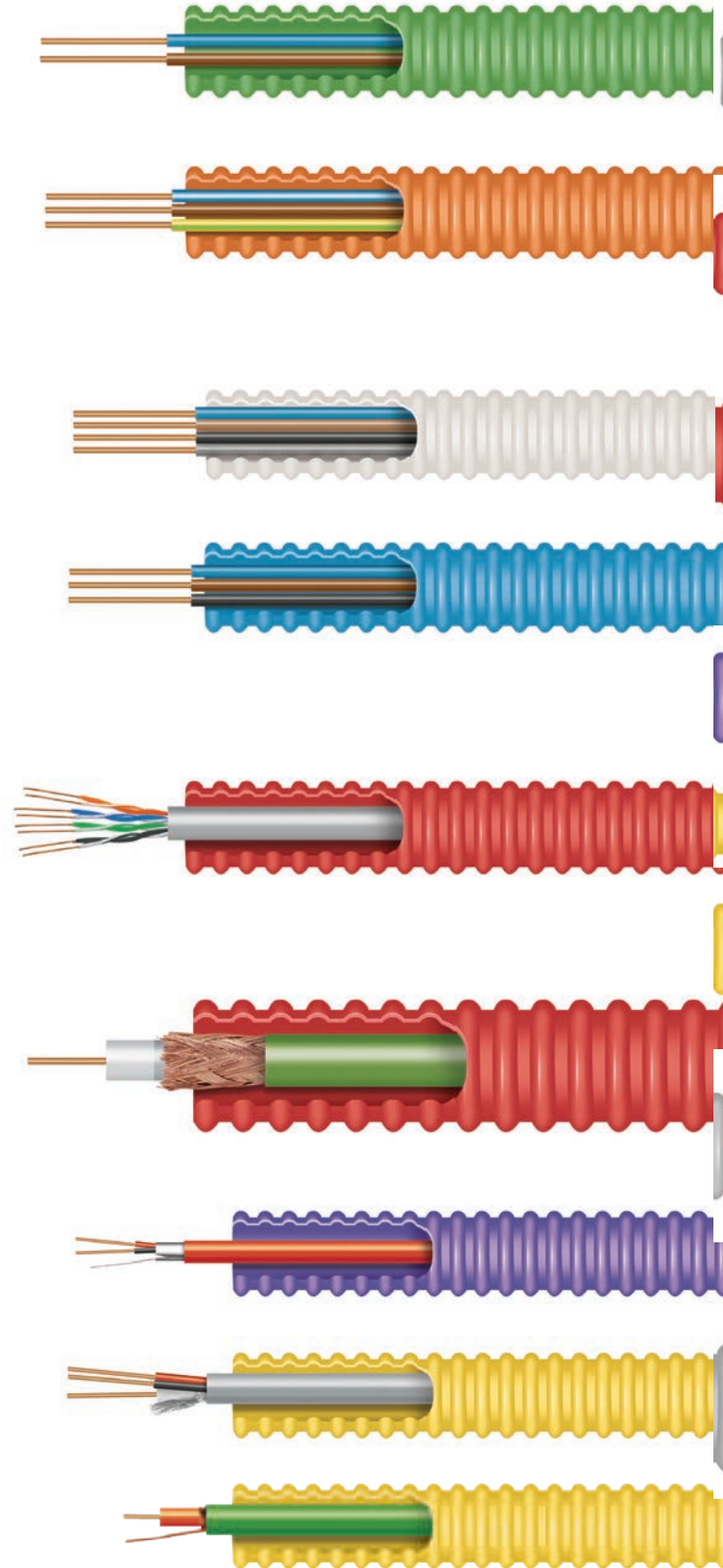

SPİRALLİ ZAYIF AKIM JY (st) Y YANGIN İHBAR KABLolarI
SPIRALS LOW CURRENT JY (st) Y FIRE SYSTEM CABLES

KOD CODE	KABLO KESİTİ CABLE DIMENSION	SPİRAL ÖZELLİK SPIRAL SPECIFICATION	SPİRAL ÇAP SPIRAL DIAMETER
122 052 401216	JY(st)Y 1x2x0.80+40 mm	HF-PE	16 mm
122 052 401216	JY(st)Y 2x2x0.80+40 mm	HF-PE	16 mm
122 052 401216	JY(st)Y 4x2x0.80+40 mm	HF-PE	20 mm

SPİRALLİ ZAYIF AKIM DİYAFON KABLolarI
SPIRALS LOW CURRENT INTERCOM CABLES

KOD CODE	KABLO KESİTİ CABLE DIMENSION	SPİRAL ÖZELLİK SPIRAL SPECIFICATION	SPİRAL ÇAP SPIRAL DIAMETER
122 052 502216	DT-8 8x0.22 mm	HF-PE	16 mm

SPİRALLİ ZAYIF AKIM DATA KABLolarI
SPIRALS LOW CURRENT DATA CABLES

KOD CODE	KABLO KESİTİ CABLE DIMENSION	SPİRAL ÖZELLİK SPIRAL SPECIFICATION	SPİRAL ÇAP SPIRAL DIAMETER
122 052 100516	U/UTP CAT5e	HF-PE	16 mm
122 052 100616	U/UTP CAT5e	HF-PE	16 mm

SPİRALLİ ZAYIF AKIM KOAKSİYEL KABLolarI
SPIRALS LOW CURRENT TV CABLES

KOD CODE	KABLO KESİTİ CABLE DIMENSION	SPİRAL ÖZELLİK SPIRAL SPECIFICATION	SPİRAL ÇAP SPIRAL DIAMETER
122 052 100214	RG 59/U2 (cu/AL)	HF-PE	14 mm
122 052 200416	RG 6/U4 (cu/AL)	HF-PE	16 mm
122 052 200616	RG 6/U6 (cu/AL)	HF-PE	16 mm

SPİRALLİ ZAYIF AKIM CCTV KAMERA KABLolarI
SPIRALS LOW CURRENT CCTV CAMERA CABLES

KOD CODE	KABLO KESİTİ CABLE DIMENSION	SPİRAL ÖZELLİK SPIRAL SPECIFICATION	SPİRAL ÇAP SPIRAL DIAMETER
122 052 301214	CCTV 1+2 (2x0.22 mm)	HF-PE	14 mm
122 052 301416	CCTV 1+4 (2x0.22 mm)	HF-PE	16 mm

SPİRALLİ ZAYIF AKIM DİYAFON KABLolarI
SPIRALS LOW CURRENT INTERCOM CABLES

KOD CODE	KABLO KESİTİ CABLE DIMENSION	SPİRAL ÖZELLİK SPIRAL SPECIFICATION	SPİRAL ÇAP SPIRAL DIAMETER
122 052 502216	DT-8 8x0.22 mm	HF-PE	16 mm

SPİRALLİ ZAYIF AKIM JY (st) Y YANGIN İHBAR KABLolarI
SPIRALS LOW CURRENT JY (st) Y FIRE SYSTEM CABLES

KOD CODE	KABLO KESİTİ CABLE DIMENSION	SPİRAL ÖZELLİK SPIRAL SPECIFICATION	SPİRAL ÇAP SPIRAL DIAMETER
122 052 401215	JY(st)Y 1x2x0.80+40 mm	HF-PE	16 mm
122 052 401216	JY(st)Y 2x2x0.80+40 mm	HF-PE	16 mm



**Borularınızda
Güç ve Güvenlik**
Strength and
Safety in Your Pipes



**PVC ALEV YAYMAYAN
BORU 750N (3M)**
PVC NON-FLAME PIPE 750N (3M)

KOD CODE	İÇ ÇAP INNER DIAMETER	DIŞ ÇAP OUTER DIAMETER	KUTU BOX	AĞIRLIK WEIGHT	HACİM VOLUME
001 045 120014 30 17	11,80mm	14mm	102	6,12	0,0204
001 045 120016 30 17	12,80mm	16mm	102	7,956	0,0306
001 045 120018 30 17	16,50mm	18mm	102	9,18	0,03519
001 045 120020 30 17	16,70mm	20mm	102	11,832	0,0357
001 045 120025 30 17	21,90mm	25mm	51	8,058	0,0306
001 045 120032 30 17	29,00mm	32mm	30	6,78	0,033
001 045 120040 30 17	37,40mm	40mm	30	10,35	0,051



**PVC ALEV YAYMAYAN
BORU MUFLU 750N(3M)**
PVC FLAMEPROOF PIPE BELL 750N(3M)

KOD CODE	İÇ ÇAP INNER DIAMETER	DIŞ ÇAP OUTER DIAMETER	KUTU BOX	AĞIRLIK WEIGHT	HACİM VOLUME
001 045 110014 30 17	11,80mm	14mm	102	7,390002	0,0204
001 045 110016 30 17	12,80mm	16mm	102	9,430002	0,0306
001 045 110018 30 17	16,50mm	18mm	102	10,761	0,03519
001 045 110020 30 17	16,70mm	20mm	102	10,506	0,04488
001 045 110025 30 17	21,90mm	25mm	51	9,435	0,0357
001 045 110032 30 17	29,00mm	32mm	30	7,14999	0,033
001 045 110040 30 17	37,40mm	40mm	30	10,14999	0,051



ALEV YAYMAYAN DİRSEK
NON-FLAME BRACKETS

KOD CODE	İÇ ÇAP INNER DIAMETER	DIŞ ÇAP OUTER DIAMETER	KUTU BOX	AĞIRLIK WEIGHT kg	HACİM VOLUME m3
001 051 010014 00 17	14mm	18mm	100	0,8	0,004880285
001 051 010016 00 17	16mm	20mm	100	1,5	0,005693667
001 051 010018 00 17	18mm	22mm	100	1,6	0,0085405
001 051 010020 00 17	20mm	24mm	100	2,3	0,011387333
001 051 010025 00 17	25mm	29mm	50	1,5	0,001138733
001 051 010032 00 17	32mm	36mm	50	1,225	0,0085405



ALEV YAYMAYAN MUF
NON-FLAME COUPLER FITTING

KOD CODE	İÇ ÇAP INNER DIAMETER	DIŞ ÇAP OUTER DIAMETER	KUTU BOX	AĞIRLIK WEIGHT kg	HACİM VOLUME m3
001 051 030014 00 17	14mm	18mm	100	1,2	0,005693667
001 051 030018 00 17	18mm	22mm	100	1,2	0,0068324
001 051 030025 00 17	25mm	29mm	50	0,9	0,005693667
001 051 030032 00 17	32mm	36mm	50	1,15	0,0085405

PVC ALEV YAYMAYAN BOY BORULAR AKSESUARLAR
PVC NON-FLAME-SPREADING LENGTH PIPES ACCESSORIES



ANTİGRON BORU KROŞESİ
ANTIGRON PIPE STRAPS

KOD CODE	AÇIKLAMA DESCRIPTION	KUTU BOX	KOLİ PARCEL	KUTU AĞIRLIK BOX WEIGHT kg	KUTU HACİM BOX VOLUME m ³
001 048 010016 00 17	16Ø ANTİGRON BORU KROŞESİ 16Ø ANTIGRON PIPE STRAPS	100	2000	0,55	0,00210
001 048 010018 00 17	18Ø ANTİGRON BORU KROŞESİ 18Ø ANTIGRON PIPE STRAPS	100	3000	0,42	0,00200
001 048 010020 00 17	20Ø ANTİGRON BORU KROŞESİ 20Ø ANTIGRON PIPE STRAPS	100	4500	0,48	0,00243
001 048 010025 00 17	25Ø ANTİGRON BORU KROŞESİ 25Ø ANTIGRON PIPE STRAPS	100	1000	0,59	0,00365
001 048 010032 00 17	32Ø ANTİGRON BORU KROŞESİ 32Ø ANTIGRON PIPE STRAPS	100	800	0,78	0,00427
001 048 010040 00 17	40Ø ANTİGRON BORU KROŞESİ 40Ø ANTIGRON PIPE STRAPS	50	750	0,46	0,00171
074 048 050016	16Ø ANTİGRON BORU KROŞESİ KAPAKLI 16Ø ANTIGRON PIPE WITH COVER STRAPS	100	4000	-	-
074 048 050017	20Ø ANTİGRON BORU KROŞESİ KAPAKLI 20Ø ANTIGRON PIPE WITH COVER STRAPS	100	3500	-	-
074 048 050025	25Ø ANTİGRON BORU KROŞESİ KAPAKLI 25Ø ANTIGRON PIPE WITH COVER STRAPS	100	3000	-	-
074 048 050032	32Ø ANTİGRON BORU KROŞESİ KAPAKLI 32Ø ANTIGRON PIPE WITH COVER STRAPS	50	1500	-	-



PLASTİK SUSTA (KLAUZ TELLİ)
PLASTIC CABLE PULLER(WITH GUIDE WIRE)

KOD CODE	AÇIKLAMA DESCRIPTION	KUTU BOX	KOLİ PARCEL
049 019 400010	PLASTİK KLAUZ TELLİ 10m PLASTIC GUIDE WIRE 10m	100	4000
049 019 400015	PLASTİK KLAUZ TELLİ 15m PLASTIC GUIDE WIRE 15m	100	3500
049 019 400020	PLASTİK KLAUZ TELLİ 20m PLASTIC GUIDE WIRE 20m	100	3000
049 019 400025	PLASTİK KLAUZ TELLİ 25m PLASTIC GUIDE WIRE 25m	50	1500



ÇELİK SUSTA
STEEL CABLE PULLER

KOD CODE	AÇIKLAMA DESCRIPTION	KUTU BOX	KOLİ PARCEL	KUTU AĞIRLIK BOX WEIGHT kg	KUTU HACİM BOX VOLUME m ³
001 019 000010 00 00	1.KALİTE 10m PREMIUM QUALITY 10m	40	40	27,60	0,025
001 019 000015 00 00	1.KALİTE 15m PREMIUM QUALITY 15m	30	30	31,08	0,025
001 019 000020 00 00	1.KALİTE 20m PREMIUM QUALITY 20m	20	20	27,56	0,025
001 019 000025 00 00	1.KALİTE 25m PREMIUM QUALITY 25m	15	15	25,8	0,025
001 019 100010 00 00	1.KALİTE 10m PREMIUM QUALITY REINFORCED 10m	40	40	28,64	0,025
001 019 100015 00 00	1.KALİTE 15m PREMIUM QUALITY REINFORCED 15m	30	30	31,98	0,025
001 019 100020 00 00	1.KALİTE 20m PREMIUM QUALITY REINFORCED 20m	20	20	28,36	0,025
001 019 100025 00 00	1.KALİTE 25m PREMIUM QUALITY REINFORCED 25m	15	15	26,55	0,025
001 018 000001 00 00	FLORASAN ZİNCİRİ FLUORESCENT CHAIN	500m	500m	20,50	0,017

HALOJEN FREE RİJİT ALEV YAYMAYAN BORULAR

FLARET HALOGEN FREE NON FLAMMABLE RIGIT PIPES



**FLARET HALOJEN FREE
ALEV YAYMAYAN BORU 320 - N (3M)**
FLORET HALOGEN FREE
NON FLAMMABLE RIGIT PIPES 320 -N (3M)

KOD CODE	İÇ ÇAP INNER DIAMETER	DIŞ ÇAP OUTER DIAMETER	KUTU BOX	AĞIRLIK WEIGHT kg	HACİM VOLUME m3
001 045 500016 30 17	12,40mm	16mm	102	7,344	0,0306
001 045 500020 30 17	16,60mm	20mm	102	9,282	0,04488
001 045 500025 30 17	20,60mm	25mm	51	6,477	0,0357
001 045 500032 30 17	28,80mm	32mm	30	5,7	0,033
001 045 500040 30 17	36,70mm	40mm	30	8,19	0,051
001 045 500050 30 17	42,90mm	50mm	30	13,65	0,07803



**FLARET HALOJEN FREE
ALEV YAYMAYAN BORU 750 - N (3M)**
FLORET HALOGEN FREE
NON FLAMMABLE RIGIT PIPES 750 -N (3M)

KOD CODE	İÇ ÇAP INNER DIAMETER	DIŞ ÇAP OUTER DIAMETER	KUTU BOX	AĞIRLIK WEIGHT kg	HACİM VOLUME m3
001 045 510016 30 17	12,40mm	16mm	102	7,65	0,0306
001 045 510020 30 17	16,00mm	20mm	102	10,2	0,04488
001 045 510025 30 17	20,60mm	25mm	51	7,14	0,0357
001 045 510032 30 17	26,80mm	32mm	30	6	0,033
001 045 510040 30 17	33,90mm	40mm	30	8,4	0,051
001 045 510050 30 17	42,90mm	50mm	30	8,499	0,07803



**FLARET HALOJEN FREE
ALEV YAYMAYAN BORU 1250 - N (3M)**
FLORET HALOGEN FREE
NON FLAMMABLE RIGIT PIPES 1250 -N (3M)

KOD CODE	İÇ ÇAP INNER DIAMETER	DIŞ ÇAP OUTER DIAMETER	KUTU BOX	AĞIRLIK WEIGHT kg	HACİM VOLUME m3
001 045 520016 30 17	12,10mm	16mm	102	8,16	0,0306
001 045 520020 30 17	15,20mm	20mm	102	10,914	0,04488
001 045 520025 30 17	20,00mm	25mm	51	7,497	0,0357
001 045 520032 30 17	25,90mm	32mm	30	6,75	0,033
001 045 520040 30 17	32,30mm	40mm	30	6,849	0,051
001 045 520050 30 17	42,00mm	50mm	30	17,85	0,07803



**BORU BÜKME YAYI
PIPE BENDING SPRING**

KOD CODE	AÇIKLAMA DESCRIPTION	ADET QUANTITY
999 999 777094	Q16 BORU BÜKME YAYI Q16 PIPE BENDING SPRING	1
999 999 777093	Q20 BORU BÜKME YAYI Q20 PIPE BENDING SPRING	1
999 999 777099	Q25 BORU BÜKME YAYI Q25 PIPE BENDING SPRING	1
999 999 777095	Q32 BORU BÜKME YAYI Q32 PIPE BENDING SPRING	1
999 999 777096	Q40 BORU BÜKME YAYI Q40 PIPE BENDING SPRING	1
999 999 777097	Q50 BORU BÜKME YAYI Q50 PIPE BENDING SPRING	1

PVC BORU AKSESUARLARI - KAPAKSIZ CABLE TERMINAL LUGS



YENİ
NEW

PVC BUAR PVC JUNCTION BOX

KOD CODE	AÇIKLAMA DESCRIPTION	ADET QUANTITY	KUTU AĞIRLIK BOX WEIGHT kg	KUTU HACİM BOX VOLUME m ³
999 998 000001	PVC BUAT 20 (1'Lİ) PVC JUNCTION BOX 20 (SINGLE)	400	12,8	0,14464
999 998 000002	PVC BUAT 20 (2'Lİ) PVC JUNCTION BOX 20 (DOUBLE)	400	17,2	0,14464
999 998 000003	PVC BUAT 20 (3'LÜ) PVC JUNCTION BOX 20 (TRIPLE)	400	19,6	0,15504
999 998 000004	PVC BUAT 20 (4'LÜ) PVC JUNCTION BOX 20 (QUADRUPLE)	400	32	0,14464
999 998 000005	PVC BUAT 25 (1'Lİ) JUNCTION BOX 25 (SINGLE)	300	5400	0,1446
999 998 000006	PVC BUAT 25 (2'Lİ) PVC JUNCTION BOX 25 (DOUBLE)	300	5400	0,1446
999 998 000007	PVC BUAT 25 (3'LÜ) PVC JUNCTION BOX 25 (TRIPLE)	300	18,6	0,15504
999 998 000008	PVC BUAT 25 (4'LÜ) JUNCTION BOX 25 (QUADRUPLE)	300	24	0,1446



PVC İNGİLİZ TİP KASA PVC BRITISH TYPE BOX

KOD CODE	AÇIKLAMA DESCRIPTION
999 998 000009	PVC İNGİLİZ TİP KASA 1'Lİ PVC BRITISH TYPE SINGLE BOX
999 998 000010	PVC İNGİLİZ TİP KASA 2'Lİ PVC BRITISH TYPE DOUBLE BOX



ALEV YAYMAYAN- BORU-SPİRAL EK MUFU NON-FLAME-PIPE-SPIRAL COUPLING

KOD CODE	AÇIKLAMA DESCRIPTION	KUTU BOX	KOLİ PARCEL	KUTU AĞIRLIK BOX WEIGHT kg	KUTU HACİM BOX VOLUME m ³
999 999 777616	16 LİK BORU PIPE	100	1000	0,3	0,0026
999 999 777620	20 LİK BORU PIPE	100	1000	0,5	0,00416
999 999 777625	25 LİK BORU PIPE	100	1000	0,6	0,0052
999 999 777632	32 LİK BORU PIPE	100	1000	1,1	0,0104



ALEV YAYMAYAN-DÜZ BORU T DİRSEK NON-FLAME-STRAIGHT PIPE T ELBOW

KOD CODE	AÇIKLAMA DESCRIPTION	KUTU BOX	KUTU AĞIRLIK BOX WEIGHT kg	KUTU HACİM BOX VOLUME m ³
999 999 999888	16 LİK DÜZ BORU STRAIGHT PIPE T ELBOW	100	1,2	0,0069333
999 999 999889	20 LİK DÜZ BORU STRAIGHT PIPE T ELBOW	100	1,5	0,0104
999 999 999890	25 LİK DÜZ BORU STRAIGHT PIPE T ELBOW	50	0,9	0,0065
999 999 999891	32 LİK DÜZ BORU STRAIGHT PIPE T ELBOW	25	0,975	0,0065



ALEV YAYMAYAN DÜZ BORU RAKORU NON-FLAME STRAIGHT PIPE FITTING

KOD CODE	AÇIKLAMA DESCRIPTION	KUTU BOX	KUTU AĞIRLIK BOX WEIGHT kg	KUTU HACİM BOX VOLUME m ³
999 999 998816	Ø16 RAKOR STRAIGHT PIPE FITTING	100	0,5	0,0026
999 999 998820	Ø20 RAKOR STRAIGHT PIPE FITTING	100	0,8	0,00416
999 999 998825	Ø25 RAKOR STRAIGHT PIPE FITTING	100	0,9	0,0052
999 999 998832	Ø32 RAKOR STRAIGHT PIPE FITTING	100	1,5	0,0104



ANTİGRON BORU KROŞESİ ANTIGRON PIPE CLAMP

KOD CODE	AÇIKLAMA DESCRIPTION	KUTU BOX	KUTU AĞIRLIK BOX WEIGHT kg	KUTU HACİM BOX VOLUME m ³
074 048 060016	Ø16 ANT. BORU KRO. ANTIGRON PIPE CLAMP	100	0,4	0,002275
074 048 060020	Ø20 ANT. BORU KRO. ANTIGRON PIPE CLAMP	100	0,5	0,002971429
074 048 060025	Ø25 ANT. BORU KRO. ANTIGRON PIPE CLAMP	100	0,6	0,00346667
074 048 060032	Ø32 ANT. BORU KRO. ANTIGRON PIPE CLAMP	100	0,9	0,0052

MUTLUSAN EKO SERİSİ TURUNCU BORULAR

PVC NON FLAMMABLE RIGIT PIPES



YENİ
NEW

Halojen Free (halojen içermeyen) teknolojiler, yangın anında zehirli gaz salınımını önleyerek insan sağlığını ve çevreyi koruyan önemli bir yenilik sunar. Geleneksel halojen bazlı malzemeler, yangın sırasında toksik ve zararlı dumanlar yayarak tehlike yaratırken, halojen içermeyen malzemeler bu riski ortadan kaldırır. Bu sayede özellikle kamuya açık alanlarda, sağlık ve güvenlik standartlarını artırmak adına Halojen Free ürünlerin kullanımı büyük önem taşır. Aynı zamanda, çevre dostu yapılarıyla sürdürülebilir bir geleceğe katkıda bulunarak, hem bireyler hem de endüstriler için ideal bir seçim haline gelirler.

Halogen Free technologies offer a significant innovation that protects human health and the environment by preventing the release of toxic gases in the event of a fire. While traditional halogen-based materials pose a danger by emitting toxic and harmful fumes during a fire, halogen-free materials eliminate this risk. Therefore, the use of Halogen Free products is of great importance, especially in public spaces, to enhance health and safety standards. Additionally, with their environmentally friendly nature, they contribute to a sustainable future, making them an ideal choice for both individuals and industries.

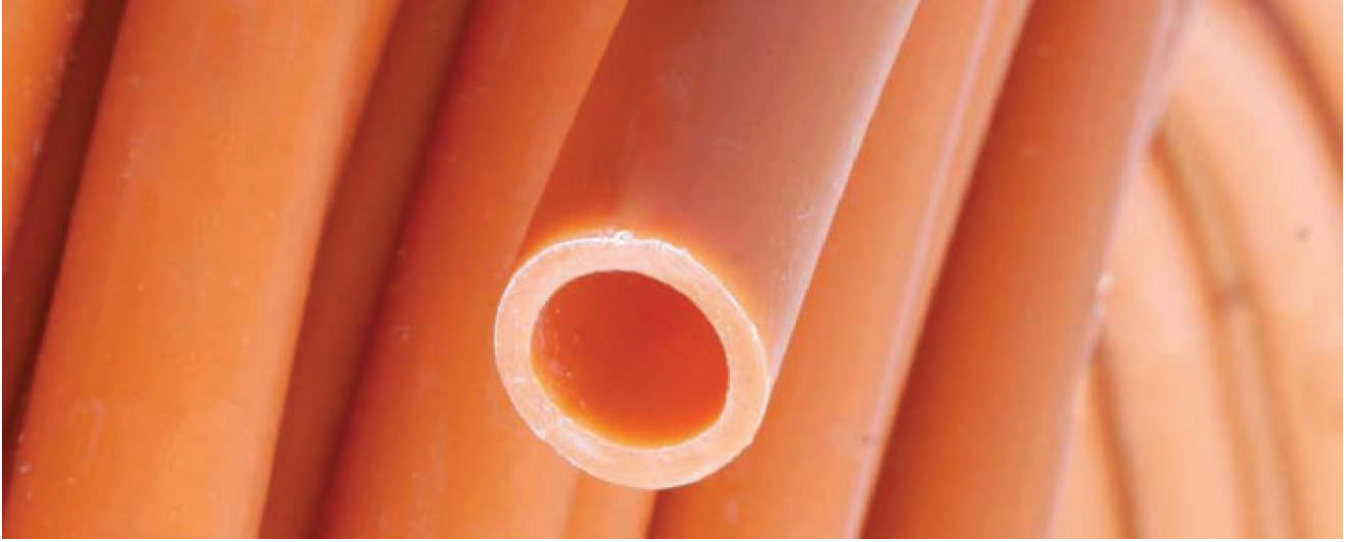

**MUTLUSAN EKO SERİ
TURUNCU BORULAR
(HALOJEN FREE)ALEV YAYAN
320N / 6ATÜ**
MUTLUSAN ECO SERIES
ORANGE PIPES
(HALOGEN FREE)FLAME SPREADING
320N / 6ATU



**MUTLUSAN EKO SERİ
MAVİ BORULAR
(HALOJEN FREE)ALEV YAYAN
320N / 6ATÜ**
MUTLUSAN ECO SERIES
BLUE PIPES
(HALOGEN FREE)FLAME SPREADING
320N / 6ATU

KOD CODE	İÇ ÇAP INNER DIAMETER	DIŞ ÇAP OUTER DIAMETER	KUTU BOX	AĞIRLIK WEIGHT	HACİM VOLUME
001 165 710014 00 12	9.4 mm	14 mm	200	14	0,10985
001 165 710016 00 12	12.4 mm	16 mm	200	16	0,14
001 165 710018 00 12	13.6 mm	18 mm	200	19,2	0,14
001 165 710020 00 12	16.0 mm	20 mm	200	23,2	0,18
001 165 710025 00 12	20.6 mm	25 mm	100	14,8	0,12
001 165 710032 00 12	26.8 mm	32 mm	100	24,7	0,21
001 165 710040 00 12	33.9 mm	40 mm	100	38,1	0,34
001 165 710050 00 12	42.9 mm	50 mm	100	53,2	0,788298

KOD CODE	İÇ ÇAP INNER DIAMETER	DIŞ ÇAP OUTER DIAMETER	KUTU BOX	AĞIRLIK WEIGHT	HACİM VOLUME
001 165 710014 00 13	9.4 mm	14 mm	200	14	0,10985
001 165 710016 00 13	12.4 mm	16 mm	200	16	0,133308
001 165 710018 00 13	13.6 mm	18 mm	200	19,2	0,145152
001 165 710020 00 13	16.0 mm	20 mm	200	23,2	0,1792
001 165 710025 00 13	20.6 mm	25 mm	100	14,8	0,1152
001 165 710032 00 13	26.8 mm	32 mm	100	24,7	0,2106
001 165 710040 00 13	33.9 mm	40 mm	100	38,1	0,3388
001 165 710050 00 13	42.9 mm	50 mm	100	53,2	0,788298

MEKS SERİSİ TURUNCU BORU HALOJEN FREE ALEV YAYAN
MEKS SERIES ORANGE PIPE HALOGEN FREE FLAME



**320 N - 6 ATÜ MEKS SERİSİ
TURUNCU BORULAR
HALOGEN FREE - ALEV YAYAN**
HALOGEN FREE SPIRALS
FLAMMABLE 320 N

KOD CODE	İÇ ÇAP INNER DIAMETER	DIŞ ÇAP OUTER DIAMETER	KUTU BOX	AĞIRLIK WEIGHT	HACİM VOLUME
001 165 506014 00 12	11,25 mm	14,50 mm	100	6,02	0,05
001 165 506016 00 12	12,65 mm	15,85 mm	100	7,021	0,066654
001 165 506018 00 12	14,60 mm	18,00 mm	100	8,3	0,07258
001 165 506020 00 12	16,45 mm	19,85 mm	100	9,7	0,0896
001 165 506025 00 12	20,80 mm	24,80 mm	100	12,9	0,1152
001 165 506032 00 12	26,80 mm	31,80 mm	100	21	0,2106
001 165 506037 00 12	30,80 mm	36,80 mm	100	27,1	0,338688
001 165 506040 00 12	33,90 mm	39,80 mm	100	31,69	0,34
001 165 506050 00 12	42,90 mm	49,75 mm	100	43,13	0,788298
001 165 506063 00 12	55,30 mm	62,70 mm	100	66,198	1,26
001 165 506075 00 12	66,00 mm	74,70 mm	100	84,252	1,557504
001 165 506090 00 12	81,80 mm	90,85 mm	75	94,03125	1,7625



**320 N - 6 ATÜ MEKS SERİSİ
TURUNCU BORULAR TELLİ
HALOGEN FREE - ALEV YAYAN**
HALOGEN FREE SPIRALS
FLAMMABLE WITH INTERNAL WIRE
320 N

KOD CODE	İÇ ÇAP INNER DIAMETER	DIŞ ÇAP OUTER DIAMETER	KUTU BOX	AĞIRLIK WEIGHT	HACİM VOLUME
001 165 906014 00 12	11,25 mm	14,50 mm	100	6	0,05
001 165 906016 00 12	12,65 mm	15,85 mm	100	7	0,07
001 165 906018 00 12	14,60 mm	18,00 mm	100	8,3	0,07
001 165 906020 00 12	16,45 mm	19,85 mm	100	9,7	0,09
001 165 906025 00 12	20,80 mm	24,80 mm	100	12,9	0,12
001 165 906032 00 12	26,80 mm	31,80 mm	100	21	0,21
001 165 906037 00 12	30,80 mm	36,80 mm	100	27,1	0,338688
001 165 906040 00 12	33,90 mm	39,80 mm	100	31,7	0,34



**750 N - 10 ATÜ MEKS SERİSİ
TURUNCU BORULAR
HALOGEN FREE - ALEV YAYAN**
HALOGEN FREE SPIRALS
FLAMMABLE 750 N

KOD CODE	İÇ ÇAP INNER DIAMETER	DIŞ ÇAP OUTER DIAMETER	KUTU BOX	AĞIRLIK WEIGHT	HACİM VOLUME
001 165 510014 00 12	10,70 mm	14,45 mm	100	7,021	0,054925
001 165 510016 00 12	12,00 mm	15,85 mm	100	8,02	0,07
001 165 510018 00 12	14,60 mm	18,00 mm	100	9,63	0,07
001 165 510020 00 12	15,15 mm	19,85 mm	100	11,63	0,09
001 165 510025 00 12	19,80 mm	24,80 mm	100	14,8	0,1152
001 165 510032 00 12	25,25 mm	31,80 mm	100	24,7	0,2106
001 165 510037 00 12	29,50 mm	36,80 mm	100	31,093	0,34
001 165 510040 00 12	32,30 mm	39,80 mm	100	38,114	0,34
001 165 510050 00 12	42,00 mm	49,75 mm	100	53,159	0,788298
001 165 510063 00 12	52,90 mm	62,70 mm	100	79,2	1,2635
001 165 510075 00 12	64,30 mm	74,70 mm	100	94,282	1,5575
001 165 510090 00 12	78,80 mm	90,85 mm	75	112,8375	1,764
001 165 510100 00 12	89,90 mm	100,95 mm	50	92,7775	1,94
001 165 510110 00 12	95,00 mm	111,00 mm	50	108,8255	2,178



**750 N - 10 ATÜ MEKS SERİSİ
TURUNCU BORULAR TELLİ
HALOGEN FREE - ALEV YAYAN**
HALOGEN FREE SPIRALS
FLAMMABLE WITH INTERNAL WIRE
750 N

KOD CODE	İÇ ÇAP INNER DIAMETER	DIŞ ÇAP OUTER DIAMETER	KUTU BOX	AĞIRLIK WEIGHT	HACİM VOLUME
001 165 910014 00 12	10,70 mm	14,45 mm	100	7	0,054925
001 165 910016 00 12	12,00 mm	15,85 mm	100	8	0,07
001 165 910018 00 12	14,60 mm	18,00 mm	100	9,6	0,07
001 165 910020 00 12	15,15 mm	19,85 mm	100	11,6	0,09
001 165 910025 00 12	19,80 mm	24,80 mm	100	14,8	0,12
001 165 910032 00 12	25,25 mm	31,80 mm	100	24,7	0,21
001 165 910037 00 12	29,50 mm	36,80 mm	100	31,1	0,34
001 165 910040 00 12	32,30 mm	39,80 mm	100	38,1	0,34



**1250 N MEKS SERİSİ
TURUNCU BORULAR
HALOGEN FREE - ALEV YAYAN**
HALOGEN FREE SPIRALS
FLAMMABLE 320 N

KOD CODE	İÇ ÇAP INNER DIAMETER	DIŞ ÇAP OUTER DIAMETER	KUTU BOX	AĞIRLIK WEIGHT	HACİM VOLUME
001 165 512020 00 12	14,50 mm	19,85 mm	100	11,6	0,09
001 165 512025 00 12	18,00 mm	24,80 mm	100	14,8	0,12
001 165 512032 00 12	25,80 mm	31,80 mm	100	24,7	0,21

**Güvenli Yapılar İçin
Halojen Free Seçimi!**
Choose Halogen-Free for
Safe Structures!

MEKS SERİSİ TURUNCU BORULAR HALOJEN FREE ALEV YAYMAYAN
PVC NON FLAMMABLE RIGIT PIPES



**320 N - 6 ATÜ MEKS SERİSİ
TURUNCU BORULAR
HALOJEN FREE - ALEV YAYMAYAN**
HALOGEN FREE SPIRALS
NON FLAMMABLE 320 N

KOD CODE	İÇ ÇAP INNER DIAMETER	DIŞ ÇAP OUTER DIAMETER	KUTU BOX	AĞIRLIK WEIGHT	HACİM VOLUME
001 165 106014 00 12	11,25 mm	14,50 mm	100	6,22	0,05493
001 165 106016 00 12	12,65 mm	15,85 mm	100	7,22	0,07
001 165 106018 00 12	14,60 mm	18,00 mm	100	8,83	0,07
001 165 106020 00 12	16,45 mm	19,85mm	100	10,03	0,0896
001 165 106025 00 12	20,80 mm	24,80 mm	100	13,5405	0,1152
001 165 106032 00 12	26,80 mm	31,80 mm	100	21,56	0,2106
001 165 106037 00 12	30,80 mm	36,80 mm	100	27,5825	0,338688
001 165 106040 00 12	33,90 mm	39,80 mm	100	32,096	0,3388
001 165 106050 00 12	42,90 mm	49,75 mm	100	44,132	0,788298
001 165 106063 00 12	55,30 mm	62,70 mm	100	67,201	1,2635
001 165 106075 00 12	66,00 mm	74,70 mm	100	85,255	1,557504
001 165 106090 00 12	81,80 mm	90,85 mm	75	96,288	1,764



**320 N - 6 ATÜ MEKS SERİSİ
TURUNCU BORULAR TELLİ
HALOJEN FREE - ALEV YAYMAYAN**
HALOGEN FREE SPIRALS
NON FLAMMABLE WITH INTERNAL
320 N

KOD CODE	İÇ ÇAP INNER DIAMETER	DIŞ ÇAP OUTER DIAMETER	KUTU BOX	AĞIRLIK WEIGHT	HACİM VOLUME
001 165 306014 00 12	11,25 mm	14,50 mm	100	6,2	0,05493
001 165 306016 00 12	12,65 mm	15,85 mm	100	7,2	0,07
001 165 306018 00 12	14,60 mm	18,00 mm	100	8,8	0,07
001 165 306020 00 12	16,45 mm	19,85mm	100	10	0,0896
001 165 306025 00 12	20,80 mm	24,80 mm	100	13,5	0,1152
001 165 306032 00 12	26,80 mm	31,80 mm	100	21,6	0,2106
001 165 306037 00 12	30,80 mm	36,80 mm	100	27,6	0,338688
001 165 306040 00 12	33,90 mm	39,80 mm	100	32,1	0,3388



**750 N - 10 ATÜ MEKS SERİSİ
TURUNCU BORULAR
HALOJEN FREE - ALEV YAYMAYAN**
HALOGEN FREE SPIRALS
NON FLAMMABLE 750 N

KOD CODE	İÇ ÇAP INNER DIAMETER	DIŞ ÇAP OUTER DIAMETER	KUTU BOX	AĞIRLIK WEIGHT	HACİM VOLUME
001 165 110014 00 12	10,70 mm	14,45 mm	100	7,2216	0,054925
001 165 110016 00 12	12,00 mm	15,85 mm	100	8,2246	0,06665
001 165 110018 00 12	14,60 mm	18,00 mm	100	9,83	0,07258
001 165 110020 00 12	15,15 mm	19,85 mm	100	12,036	0,0896
001 165 110025 00 12	19,80 mm	24,80 mm	100	15,25	0,1152
001 165 110032 00 12	25,25 mm	31,80 mm	100	25,075	0,2106
001 165 110037 00 12	29,50 mm	36,80 mm	100	31,5945	0,338688
001 165 110040 00 12	32,30 mm	39,80 mm	100	39,117	0,3388
001 165 110050 00 12	42,00 mm	49,75 mm	100	54,162	0,788298
001 165 110063 00 12	52,90 mm	62,70 mm	100	80,24	1,2635
001 165 110075 00 12	64,30 mm	74,70 mm	100	95,285	1,557504
001 165 110090 00 12	78,80 mm	90,85 mm	75	112,8375	1,764
001 165 110100 00 12	89,90 mm	100,95 mm	50	95,285	1,94145
001 165 110110 00 12	95,00 mm	111,00 mm	50	110,33	2,178



**750 N - 10 ATÜ MEKS SERİSİ
TURUNCU BORULAR TELLİ
HALOJEN FREE - ALEV YAYMAYAN**
HALOGEN FREE SPIRALS
NON FLAMMABLE WITH INTERNAL
750 N

KOD CODE	İÇ ÇAP INNER DIAMETER	DIŞ ÇAP OUTER DIAMETER	KUTU BOX	AĞIRLIK WEIGHT	HACİM VOLUME
001 165 310014 00 12	10,70 mm	14,45 mm	100	7,2	0,054925
001 165 310016 00 12	12,00 mm	15,85 mm	100	8,2	0,06665
001 165 310018 00 12	14,60 mm	18,00 mm	100	9,8	0,07258
001 165 310020 00 12	15,15 mm	19,85 mm	100	12	0,0896
001 165 310025 00 12	19,80 mm	24,80 mm	100	15,3	0,1152
001 165 310032 00 12	25,25 mm	31,80 mm	100	25,1	0,2106
001 165 310037 00 12	29,50 mm	36,80 mm	100	31,6	0,338688
001 165 310040 00 12	32,30 mm	39,80 mm	100	39,1	0,3388

PLASTİK BORULAR

PLASTIC PIPES



KOD CODE	AÇIKLAMA DESCRIPTION	İÇ ÇAP INNER DIAMETER	DIŞ ÇAP OUTER DIAMETER	KUTU BOX	AĞIRLIK WEIGHT	HACİM VOLUME
001 045 000014 30 00	Ø14 KALIN BOY BORU(3M) / 14 mm THICK PIPES	12,6 mm	15 mm	102	4,59	0,0306
001 045 000018 30 00	Ø18 KALIN BOY BORU(3M) / 18 mm THICK PIPES	16,5 mm	13,2 mm	102	5,61	0,0408
001 045 000026 30 00	Ø26 KALIN BOY BORU(3M) / 26 mm THICK PIPES	22,9 mm	26,6 mm	51	6,12	0,0408
001 045 000037 30 00	Ø37 KALIN BOY BORU(3M) / 37 mm THICK PIPES	31,5 mm	37,3 mm	30	7,5	0,06
001 045 010014 50 11	Ø14 KANGAL(NORMAL)(SİYAH) / 14 mm THICK PIPES (NORMAL)	12,6 mm	14,8 mm	100	4,5	0,08
001 045 010018 00 11	Ø18 KANGAL(NORMAL)(SİYAH) / 18 mm THICK PIPES (NORMAL)	15,7mm	17,7 mm	100	5,5	0,08
001 045 010026 00 11	Ø26 KANGAL(NORMAL)(SİYAH) / 26 mm THICK PIPES (NORMAL)	26mm	24,3 mm	50	6	0,085
001 045 010037 00 11	Ø37 KANGAL(NORMAL)(SİYAH) / 37 mm THICK PIPES (NORMAL)	31,2mm	27,3 mm	50	12,5	0,145
001 045 020014 00 00	Ø14 KANGAL(KAUÇUK) / 14 mm COIL (RUBBER)	11,4mm	14,7 mm	100	4,8	0,05
001 045 020018 00 00	Ø18 KANGAL(KAUÇUK) / 18 mm COIL (RUBBER)	14,2mm	18,5 mm	100	6,2	0,08
001 045 020026 00 00	Ø26 KANGAL(KAUÇUK) / 26 mm COIL (RUBBER)	22mm	26,5 mm	50	6	0,085
001 045 020037 00 00	Ø37 KANGAL(KAUÇUK) / 37 mm COIL (RUBBER)	31mm	37 mm	50	12,5	0,145
001 045 030014 00 00	Ø14 KANGAL(KAUÇUK)(KALIN) / 14 mm COIL (RUBBER) (THICK)	14mm		100	5,5	0,05
001 045 030018 00 00	Ø18 KANGAL(KAUÇUK)(KALIN) / 18 mm COIL (RUBBER) (THICK)	18mm		100	7	0,08



PLASTİK DİRSEK

PLASTIC BRACKETS

KOD CODE	İÇ ÇAP INNER DIAMETER	KUTU BOX	AĞIRLIK WEIGHT	HACİM VOLUME
127 051 000014	14mm	100	0,6	0,005
127 051 000018	18mm	100	0,7	0,009
127 051 000026	26mm	100	1,5	0,0243



PLASTİK MUFLAR

PLASTIC PIPE SOCKETS

KOD CODE	İÇ ÇAP INNER DIAMETER	KUTU BOX	AĞIRLIK WEIGHT	HACİM VOLUME
001 051 020014 00 11	14mm	100	0,3	0,002277
001 051 020018 00 11	18mm	100	0,5	0,003416
001 051 020026 00 11	26mm	500	4,5	0,05
001 051 020037 00 11	37mm	200	2,8	0,03648

POLİETİLEN SİYAH YER ALTI BORULAR 450 N

POLYETHYLENE BLACK UNDERGROUND PIPES 450 N



KOD CODE	AÇIKLAMA DESCRIPTION	İÇ ÇAP INNER DIAMETER	DIŞ ÇAP OUTER DIAMETER	KUTU BOX	AĞIRLIK WEIGHT	HACİM VOLUME
001 165 406014 00 11	Ø14/6 ATÜ POLİETİLEN BORU(SİYAH)	11,50mm	14,65mm	100	5,7	0,054925
001 165 406016 00 11	Ø16/6 ATÜ POLİETİLEN BORU(SİYAH)	12,75mm	16mm	100	6,9	0,066654
001 165 406018 00 11	Ø18/6 ATÜ POLİETİLEN BORU(SİYAH)	14,70mm	18,10mm	100	8,0	0,07
001 165 406020 00 11	Ø20/6 ATÜ POLİETİLEN BORU(SİYAH)	16,25mm	20mm	100	9,0	0,09
001 165 406025 00 11	Ø25/6 ATÜ POLİETİLEN BORU(SİYAH)	20,79mm	25mm	100	13,0	0,1152
001 165 406032 00 11	Ø32/6 ATÜ POLİETİLEN BORU(SİYAH)	26,80mm	32mm	100	19,8	0,2106
001 165 406037 00 11	Ø37/6 ATÜ POLİETİLEN BORU(SİYAH)	30,27mm	37mm	100	26,0	0,338688
001 165 406040 00 11	Ø40/6 ATÜ POLİETİLEN BORU(SİYAH)	33,90mm	40mm	100	30,0	0,3388
001 165 406050 00 11	Ø50/6 ATÜ POLİETİLEN BORU(SİYAH)	42,90mm	50mm	100	46,0	0,79
001 165 406063 00 11	Ø63/6 ATÜ POLİETİLEN BORU(SİYAH)	55,30mm	63mm	100	63,0	1,2635
001 165 406075 00 11	Ø75/6 ATÜ POLİETİLEN BORU(SİYAH)	66mm	75mm	100	80,0	1,557504
001 165 406090 00 11	Ø90/6 ATÜ POLİETİLEN BORU(SİYAH)	81,80mm	90mm	75	97,35	1,764

POLİETİLEN SİYAH YER ALTI BORULAR 750 N

POLYETHYLENE BLACK UNDERGROUND PIPES 750 N

KOD CODE	AÇIKLAMA DESCRIPTION	İÇ ÇAP INNER DIAMETER	DIŞ ÇAP OUTER DIAMETER	KUTU BOX	AĞIRLIK WEIGHT	HACİM VOLUME
001 165 410014 00 11	Ø14/10 ATÜ POLİETİLEN BORU(SİYAH)	10,50mm	14,65mm	100	6,30	0,054925
001 165 410016 00 11	Ø16/10 ATÜ POLİETİLEN BORU(SİYAH)	12mm	16mm	100	7,40	0,066654
001 165 410018 00 11	Ø18/10 ATÜ POLİETİLEN BORU(SİYAH)	14,30mm	18,10mm	100	9,0	0,072576
001 165 410020 00 11	Ø20/10 ATÜ POLİETİLEN BORU(SİYAH)	15,30mm	20mm	100	11,0	0,0896
001 165 410025 00 11	Ø25/10 ATÜ POLİETİLEN BORU(SİYAH)	19,80mm	25mm	100	14,10	0,1152
001 165 410032 00 11	Ø32/10 ATÜ POLİETİLEN BORU(SİYAH)	25,80mm	32mm	100	21,3	0,2106
001 165 410037 00 11	Ø37/10 ATÜ POLİETİLEN BORU(SİYAH)	29,50mm	37mm	100	29,0	0,338688
001 165 410040 00 11	Ø40/10 ATÜ POLİETİLEN BORU(SİYAH)	32,30mm	40mm	100	34,0	0,3388
001 165 410050 00 11	Ø50/10 ATÜ POLİETİLEN BORU(SİYAH)	42mm	50mm	100	55,0	0,788298
001 165 410063 00 11	Ø63/10 ATÜ POLİETİLEN BORU(SİYAH)	52,90mm	63mm	100	70,0	1,2635
001 165 410075 00 11	Ø75/10 ATÜ POLİETİLEN BORU(SİYAH)	64,30mm	75mm	100	90,0	1,557504
001 165 410090 00 11	Ø90/10 ATÜ POLİETİLEN BORU(SİYAH)	78,80mm	90mm	75	146,0	1,764





Tüm Bağlantılar İçin Plastik Kasa Buatlar

Plastic Case Junction Boxes for All Connections



BETON DUVAR KASALARI PLASTİK KASA VE BUATLAR

CONCRETE WALL CASINGS

PLASTIC CASINGS AND JUNCTION BOXES

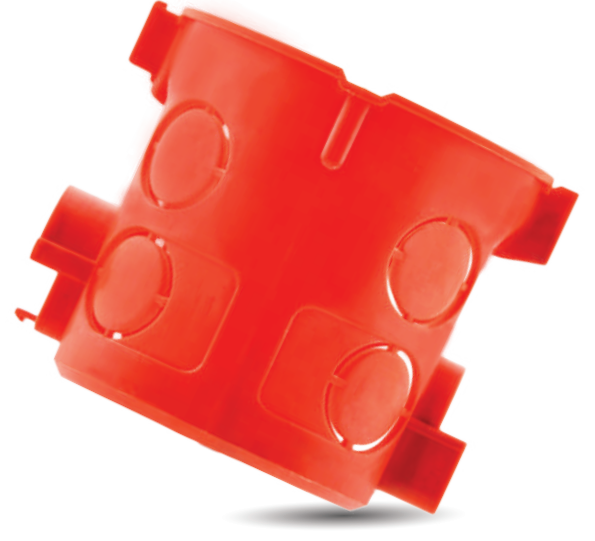

PLASTİK KASA-BUAT-TAKOZLAR PLASTIC BOX-JUNCTION BOX-SPACERS

TURUNCU KASA VE BUATLAR ORANGE BOXES AND JUNCTION BOXES

BETON DUVAR ANAHTAR KASALARI CONCRETE WALL SWITCH BOXES

KARE BUAT SQUARE JUNCTION BOX

LÜKS BUAT KAPAKLARI LUXURY JUNCTION BOX COVERS

KARE BUAT KAPAKLARI SQUARE JUNCTION BOX COVERS

BETON DUVAR ANAHTAR KASALARI - ALEV YAYAN
PLASTIC JUNCTION BOXES - CASINGS -

KOD CODE	ÜRÜN ADI PRODUCT NAME	AMBALAJ PACKING	ADET QUANTITY	AĞIRLIK WEIGHT	HACİM VOLUME
000 700 000037 00 14	BUAT ARKA KAPAK SARI	KUTU PACK	500	6 kg	0,018
000 700 000035 00 12	BUAT GÖVDE 60'LİK TURUNCU	KUTU PACK	350	9,45 kg	0,130
000 700 000256 00 14	KALIBA TESPİT ELEMANI SARI	KUTU PACK	250	4,09 kg	0,65
000 700 000039 00 12	SIÇ BRÜT ANAH. KASASI TURUNCU	KUTU PACK	500	12,53 kg	0,130
000 700 000036 00 14	KONİK GÖVDE SARI	KUTU PACK	250	4,63 kg	0,034
000 700 000214 00 14	APLİK 20'LİK SARI	KUTU PACK	1000	4,34 kg	0,029
000 700 000215 00 12	APLİK EÇİK BAĞLANTI DİRSEĞİ TURUNCU	KUTU PACK	1000	3,54 kg	0,039

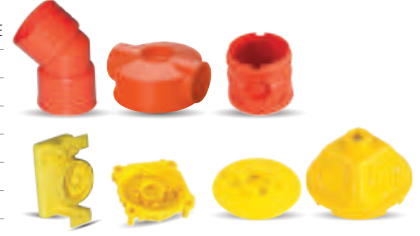

BETON DUVAR ANAHTAR KASALARI - ALEV YAYMAYAN
PLASTIC JUNCTION BOXES - CASINGS -

KOD CODE	ÜRÜN ADI PRODUCT NAME	AMBALAJ PACKING	ADET QUANTITY	AĞIRLIK WEIGHT	HACİM VOLUME
000 700 200037 00 14	BUAT ARKA KAPAK SARI	KUTU PACK	500	6 kg	0,018
000 700 200035 00 12	BUAT GÖVDE 60'LİK TURUNCU	KUTU PACK	350	9,45 kg	0,130
000 700 200256 00 14	KALIBA TESPİT ELEMANI SARI	KUTU PACK	250	4,09 kg	0,65
000 700 200039 00 12	SIÇ BRÜT ANAH. KASASI TURUNCU	KUTU PACK	500	12,53 kg	0,130
000 700 200036 00 14	KONİK GÖVDE SARI	KUTU PACK	250	4,63 kg	0,034
000 700 200214 00 14	APLİK 20'LİK SARI	KUTU PACK	1000	4,34 kg	0,029
000 700 200215 00 12	APLİK EÇİK BAĞLANTI DİRSEĞİ TURUNCU	KUTU PACK	1000	3,54 kg	0,039



KARE BUATLAR

PLASTIC JUNCTION BOXES - CASINGS -

KOD CODE	ÜRÜN ADI PRODUCT NAME	AMBALAJ PACKING	ADET QUANTITY
001 046 021010 00 11	10X10 KARE BUAT (SİYAH)	KUTU PACK	10
001 046 021212 00 11	12X12 KARE BUAT (SİYAH)	KUTU PACK	10
001 046 021515 00 11	15X15 KARE BUAT (SİYAH)	KUTU PACK	10
001 046 022020 00 11	20X20 KARE BUAT (SİYAH)	KUTU PACK	10
001 046 000103 00 11	ANTİGRON BUAT 3'LÜ PLASTİK (SİYAH)	KUTU PACK	10
001 046 000104 00 11	ANTİGRON BUAT 4'LÜ PLASTİK (SİYAH)	KUTU PACK	10
001 046 000103 00 00	ANTİGRON BUAT 3'LÜ PLASTİK (BEYAZ)	KUTU PACK	10
001 046 000104 00 00	ANTİGRON BUAT 4'LÜ PLASTİK (BEYAZ)	KUTU PACK	10
001 046 021010 00 12	10X10 KARE BUAT TURUNCU	KUTU PACK	10
001 046 021212 00 12	12X12 KARE BUAT TURUNCU	KUTU PACK	10
001 046 021515 00 12	15X15 KARE BUAT TURUNCU	KUTU PACK	10
001 046 022020 00 12	20X20 KARE BUAT TURUNCU	KUTU PACK	10
001 046 000103 00 12	ANTİGRON BUAT 3'LÜ TURUNCU	KUTU PACK	10
001 046 000104 00 12	ANTİGRON BUAT 4'LÜ TURUNCU	KUTU PACK	10

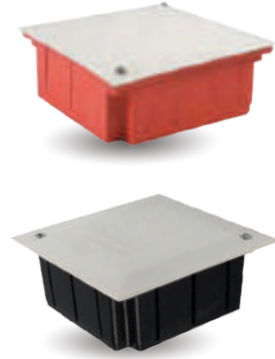

TURUNCU KARE BUATLAR - ALEV YAYMAYAN
PLASTIC JUNCTION BOXES - CASINGS -

KOD CODE	ÜRÜN ADI PRODUCT NAME	AMBALAJ PACKING	ADET QUANTITY
001 046 051010 00 12	KARE BUAT TURUNCU(10X10)	KUTU PACK	100
001 046 051212 00 12	KARE BUAT TURUNCU(12X12)	KUTU PACK	50
001 046 051515 00 12	KARE BUAT TURUNCU(15X15)	KUTU PACK	100
001 046 052020 00 12	KARE BUAT TURUNCU(20X20)	KUTU PACK	100



LÜKS BUAT KAPAKLARI

PLASTIC JUNCTION BOXES - CASINGS -

KOD CODE	ÜRÜN ADI PRODUCT NAME	AMBALAJ PACKING	ADET QUANTITY
126 046 180001	LÜKS BUAT KAPAĞI(BOMBELİ-PLS. AYAK)	KUTU PACK	100
126 046 180003	LÜKS BUAT KAPAĞI(DÜZ PLS. AYAK)	KUTU PACK	50
126 046 180004	LÜKS BUAT KAPAĞI(BOMB.PLS.AYAK)VIDALI	KUTU PACK	100



KARE BUAT KAPAKLARI

PLASTIC JUNCTION BOXES - CASINGS -

KOD CODE	ÜRÜN ADI PRODUCT NAME	AMBALAJ PACKING	ADET QUANTITY
000 700 000043 00 00	10X10 KARE BUAT KAPAĞI	KUTU PACK	1
000 700 000045 00 00	12X12 KARE BUAT KAPAĞI	KUTU PACK	1
000 700 000047 00 00	15X15 KARE BUAT KAPAĞI	KUTU PACK	1
000 700 000049 00 00	20X20 KARE BUAT KAPAĞI	KUTU PACK	1



PLASTİK BUAT - KASA - TAKOZLAR
PLASTIC JUNCTION BOXES - CASINGS -

KOD CODE	ÜRÜN ADI PRODUCT NAME	AMBALAJ PACKING	ADET QUANTITY
001 046 130102 00 11	NORM KASA NORM CASE	KUTU PACK	100
001 046 130101 00 11	NORM BUAT (14-18 ÇIKIŞLI) NORM JUNCTION BOX(WITH 14-18 OUTLETS)	KUTU PACK	50
001 046 130105 00 11	NORM BUAT KAPAKSIZ NORM JUNCTION BOX WITHOUT COVER	KUTU PACK	50
001 046 160102 00 11	GEÇMELİ PLASTİK KASA INSTALLABLE PLASTIC CASE	KUTU PACK	100
001 046 160101 00 11	GEÇMELİ DERİN KASA CLICK-FIT DEEP CASING	KUTU PACK	100
001 046 130107 00 11	GEÇMELİ DERİN KASA KAPAKSIZ CLICK-FIT DEEP BODY WITHOUT COVER	KUTU PACK	100
001 046 120101 00 11	ALÇIPAN KASA 1'Lİ DRYWALL CASING SINGLE	KUTU PACK	75
001 046 120102 00 11	ALÇIPAN KASA 2'Lİ DRYWALL CASING DOUBLE	KUTU PACK	50
001 046 120103 00 11	ALÇIPAN KASA 3'Lİ DRYWALL CASING TRIPLE	KUTU PACK	25
001 046 120100 00 11	GEÇMELİ ALÇ.KASA SİYAH INSTALLABLE PLASTIC CASE BLACK	KUTU PACK	50
001 046 170101 00 11	TÜNEL KASA TUNNEL CASING	KUTU PACK	100
001 046 170102 00 11	TÜNEL BUAT TUNNEL JUNCTION BOX	KUTU PACK	50
001 046 000001 00 11	PLASTİK TAKOZ (14-18 ÇIKIŞLI) PLASTIC WEDGE (WITH 14-18 OUTLETS)	KUTU PACK	100



TURUNCU BUAT VE KASALAR - HALOJEN FREE - ALEV YAYAN
ORANGE JUNCTION BOXES AND CASINGS

KOD CODE	ÜRÜN ADI PRODUCT NAME	AMBALAJ PACKING	ADET QUANTITY
001 046 130202 00 12	NORM KASA NORM CASE	KUTU PACK	100
001 046 130201 00 12	NORM BUAT NORM JUNCTION BOX	KUTU PACK	50
001 046 160201 00 12	GEÇMELİ DERİN KASA CLICK-FIT DEEP CASING	KUTU PACK	50













TURUNCU KASA VE BUATLAR - ALEV YAYAN
PLASTIC JUNCTION BOXES - CASINGS -

KOD CODE	ÜRÜN ADI PRODUCT NAME	AMBALAJ PACKING	ADET QUANTITY
001 046 130102 00 11	NORM KASA NORM CASE	KUTU PACK	100
001 046 130101 00 11	NORM BUAT NORM JUNCTION BOX	KUTU PACK	50
001 046 130105 00 11	GEÇMELİ PLASTİK KASA INSTALLABLE PLASTIC CASE	KUTU PACK	100
001 046 160102 00 11	GEÇMELİ PLASTİK KASA INSTALLABLE PLASTIC CASE	KUTU PACK	100
001 046 160101 00 11	TÜNEL KASA TUNNEL CASING	KUTU PACK	100
001 046 130107 00 11	TÜNEL BUAT UNNEL JUNCTION BOX	KUTU PACK	50
001 046 120101 00 11	ALÇIPAN KASA 1'Lİ DRYWALL CASING SINGLE	KUTU PACK	75
001 046 120102 00 11	ALÇIPAN KASA 2'Lİ DRYWALL CASING DOUBLE	KUTU PACK	50
001 046 120103 00 11	ALÇIPAN KASA 3'Lİ DRYWALL CASING TRIPLE	KUTU PACK	25
001 046 120100 00 11	GEÇMELİ ALÇ.KASA INSTALLABLE PLASTIC CASE	KUTU PACK	50



TURUNCU KASA VE BUATLAR - ALEV YAYMAYAN
PLASTIC JUNCTION BOXES - CASINGS -

KOD CODE	ÜRÜN ADI PRODUCT NAME	AMBALAJ PACKING	ADET QUANTITY	
001 046 131102 00 12	NORM KASA NORM CASE	KUTU PACK	100	
001 046 131101 00 12	NORM BUAT NORM JUNCTION BOX	KUTU PACK	50	
001 046 161102 00 12	GEÇMELİ PLASTİK KASA	KUTU PACK	100	
001 046 161101 00 12	GEÇMELİ DERİN KASA	KUTU PACK	100	
001 046 210002 00 12	TÜNEL KASA	KUTU PACK	100	
001 046 210003 00 12	TÜNEL BUAT	KUTU PACK	50	
001 046 121101 00 12	ALÇIPAN KASA 1'Lİ	KUTU PACK	75	
001 046 121102 00 12	ALÇIPAN KASA 2'Lİ	KUTU PACK	50	
001 046 121103 00 12	ALÇIPAN KASA 3'Lİ	KUTU PACK	25	
001 046 121100 00 12	GEÇMELİ ALÇ.KASA	KUTU PACK	50	





MUTLUSAN BETON ÇİVİLİ KROŞELER
MUTLUSAN CABLESTRAPS WITH CONCRETE NAIL

KOD CODE	AÇIKLAMA DESCRIPTION	AMBALAJ PACKING	ADET PACKING	AĞIRLIK WEIGHT	HACİM VOLUME
032 048 070000	NO:0 BETON ÇİVİLİ KROŞE/ 0,75 YASSI KORD. KÖŞE NO:0 CABLE STRAP WITH CONCRETE NAIL/ 0,75 FLAT CORD CABLE STRAP	KUTU PACK	30000	26,7 kg	0,060
032 048 070001	NO:1 BETON ÇİVİLİ KROŞE/ 0,75 YASSI KORD. KÖŞE NO:1 CABLE STRAP WITH CONCRETE NAIL/ 0,75 FLAT CORD CABLE STRAP	KUTU PACK	30000	27 kg	0,060
032 048 070002	NO:2 BETON ÇİVİLİ KROŞE/ 0,75 YASSI KORD. KÖŞE NO:2 CABLE STRAP WITH CONCRETE NAIL/ 0,75 FLAT CORD CABLE STRAP	KUTU PACK	20000	20 kg	0,028
032 048 070003	NO:3 BETON ÇİVİLİ KROŞE/ 2x1.5-3x1.5 NO:3 CABLE STRAP WITH CONCRETE NAIL/ 2x1.5 - 3x1.5	KUTU PACK	20000	28 kg	0,060
032 048 070004	NO:4 BETON ÇİVİLİ KROŞE/ 2x4 NO:4 CABLE STRAP WITH CONCRETE NAIL/ 2x4	KUTU PACK	20000	30 kg	0,060
032 048 070005	NO:5 BETON ÇİVİLİ KROŞE/ 2x4 - 4x4 NO:5 CABLE STRAP WITH CONCRETE NAIL/ 2x4 - 4x4	KUTU PACK	10000	20 kg	0,050
032 048 070006	NO:6 BETON ÇİVİLİ KROŞE/ 2x6 NO:6 CABLE STRAP WITH CONCRETE NAIL/ 2x6	KUTU PACK	10000	10 kg	0,100
032 048 070007	NO:7 BETON ÇİVİLİ KROŞE/ 4x10 NO:7 CABLE STRAP WITH CONCRETE NAIL/ 4x10	KUTU PACK	8000	31,2 kg	0,080
032 048 070008	NO:8 BETON ÇİVİLİ KROŞE/ 3x16+10 NO:8 CABLE STRAP WITH CONCRETE NAIL/ 3x16+10	KUTU PACK	5000	31 kg	0,080



GALVANİZ SAC KROŞELER
GALVANIZED SHEET CABLE STRAPS

KOD CODE	AÇIKLAMA DESCRIPTION	AMBALAJ PACKING	ADET PACKING	AĞIRLIK WEIGHT	HACİM VOLUME
001 048 060001 00 00	NO. 1 TEKLİ GALVANİZ SAC KROŞE 12MM NO:0 CABLE STRAP WITH CONCRETE NAIL/ 0,75 FLAT CORD CABLE STRAP	KUTU PACK	1500	6,60 kg	0,0060
001 048 060002 00 00	NO. 2 TEKLİ GALVANİZ SAC KROŞE 14MM NO:1 CABLE STRAP WITH CONCRETE NAIL/ 0,75 FLAT CORD CABLE STRAP	KUTU PACK	1000	6,00 kg	0,0060
001 048 060003 00 00	NO. 3 TEKLİ GALVANİZ SAC KROŞE 17MM NO:2 CABLE STRAP WITH CONCRETE NAIL/ 0,75 FLAT CORD CABLE STRAP	KUTU PACK	700	5,11 kg	0,0063
001 048 060004 00 00	NO. 4 TEKLİ GALVANİZ SAC KROŞE 20MM NO:3 CABLE STRAP WITH CONCRETE NAIL/ 2x1.5 - 3x1.5	KUTU PACK	500	4,25 kg	0,0060
001 048 060007 00 00	NO. 7 TEKLİ GALVANİZ SAC KROŞE 26MM NO:4 CABLE STRAP WITH CONCRETE NAIL/ 2x4	KUTU PACK	350	3,82 kg	0,0059
001 048 060008 00 00	NO. 8 TEKLİ GALVANİZ SAC KROŞE 34MM NO:5 CABLE STRAP WITH CONCRETE NAIL/ 2x4 - 4x4	KUTU PACK	250	3,28 kg	0,0060
001 048 060009 00 00	NO. 9 TEKLİ GALVANİZ SAC KROŞE 43MM NO:6 CABLE STRAP WITH CONCRETE NAIL/ 2x6	KUTU PACK	200	2,98 kg	0,0060
001 048 060010 00 00	NO. 10 TEKLİ GALVANİZ SAC KROŞE 53MM NO:7 CABLE STRAP WITH CONCRETE NAIL/ 4x10	KUTU PACK	150	2,31 kg	0,0060
001 048 060011 00 00	NO. 11 TEKLİ GALVANİZ SAC KROŞE 55MM NO:8 CABLE STRAP WITH CONCRETE NAIL/ 3x16+10	KUTU PACK	120	-	-
001 048 070002 00 00	NO. 2 ÇİFTLİ GALVANİZ SAC KROŞE 13MM NO:8 CABLE STRAP WITH CONCRETE NAIL/ 3x16+10	KUTU PACK	600	4,85 kg	0,0060
001 048 070003 00 00	NO. 3 ÇİFTLİ GALVANİZ SAC KROŞE 16MM NO:8 CABLE STRAP WITH CONCRETE NAIL/ 3x16+10	KUTU PACK	500	4,17 kg	0,0060
001 048 070004 00 00	NO. 4 ÇİFTLİ GALVANİZ SAC KROŞE 22MM NO:8 CABLE STRAP WITH CONCRETE NAIL/ 3x16+10	KUTU PACK	400	3,70 kg	0,0060
001 048 070007 00 00	NO. 7 ÇİFTLİ GALVANİZ SAC KROŞE 25MM NO:8 CABLE STRAP WITH CONCRETE NAIL/ 3x16+10	KUTU PACK	400	4,92 kg	0,0080
001 048 070008 00 00	NO. 8 ÇİFTLİ GALVANİZ SAC KROŞE 35MM NO:8 CABLE STRAP WITH CONCRETE NAIL/ 3x16+10	KUTU PACK	300	4,09 kg	0,0078
001 048 070009 00 00	NO. 9 ÇİFTLİ GALVANİZ SAC KROŞE 45MM NO:8 CABLE STRAP WITH CONCRETE NAIL/ 3x16+10	KUTU PACK	200	3,43 kg	0,0078
001 048 070010 00 00	NO. 10 ÇİFTLİ GALVANİZ SAC KROŞE 50MM NO:8 CABLE STRAP WITH CONCRETE NAIL/ 3x16+10	KUTU PACK	150	2,84 kg	0,0078
001 048 070011 00 00	NO. 11 ÇİFTLİ GALVANİZ SAC KROŞE 55MM NO:8 CABLE STRAP WITH CONCRETE NAIL/ 3x16+10	KUTU PACK	100	2,08 kg	0,0060

KROŞELER CABLE STRAPS



BORU GEÇME TOPRAKLAMA ÇUBUĞU EARTHING STICKS

KOD CODE	AÇIKLAMA DESCRIPTION	AMBALAJ PACKING	ADET PACKING
091 025 011610	TOP ÇUBUĞU BORU GEÇMELİ 16 MM 1 MT EARTHING STICK 16 MM	KUTU PACK	10
091 025 011615	TOP ÇUBUĞU BORU GEÇMELİ 16 MM 1,5 MT EARTHING STICK 16 MM	KUTU PACK	10
091 025 012010	TOP ÇUBUĞU BORU GEÇMELİ 20 MM 1 MT EARTHING STICK 16 MM	KUTU PACK	5
091 025 012015	TOP ÇUBUĞU BORU GEÇMELİ 20 MM 1,5 MT EARTHING STICK 16 MM	KUTU PACK	5



RAY KROŞE VE TANDIR KROŞE RAIL CABLE STRAPS

035 048 100001	NO. 1 RAY KROŞE (2X1.5-4X2.5) NO:1 RAIL CABLE STRAPS	KUTU PACK	350	2,34 kg	0,0056
035 048 100002	NO. 2 RAY KROŞE (4X4-4X16) NO:2 RAIL CABLE STRAPS	KUTU PACK	250	2,13 kg	0,0057
001 025 010100 00 00	GALVANİZ KROŞE RAYI (1M) GALVANIZED CABLE STRAPS	KUTU PACK	50	12,50 kg	0,0012
035 048 110001	NO. 1 TANDIR KROŞE (2X1.5-2X6) NO:1 METALLIC CABLE STRAPS	KUTU PACK	350	3,87 kg	0,0027
035 048 110002	NO. 2 TANDIR KROŞE (4X6) NO:2 METALLIC CABLE STRAPS	KUTU PACK	250	2,16 kg	0,00275
035 048 110003	NO. 3 TANDIR KROŞE (4X10) NO:3 METALLIC CABLE STRAPS	KUTU PACK	250	1,90 kg	0,0020
035 048 110004	NO. 4 TANDIR KROŞE (4X16) NO:4 METALLIC CABLE STRAPS	KUTU PACK	150	2,11 kg	0,00285
035 048 110005	NO. 5 TANDIR KROŞE (3X25+16) NO:5 METALLIC CABLE STRAPS	KUTU PACK	150	2,21 kg	0,00281



PLASTİK DÜBELLER PLASTIC ANCHOR

016 053 000014	BURGULU ALÇIPAN DÜBELİ (YENİ) SHEATHING SCREW ANCHOR	KUTU PACK	10000	11 kg	0,030
001 053 000001 00 00	ALÇIPAN DÜBEL SCREW ANCHOR PLASTER (WHITE) 2MM	KUTU PACK	15000	24 kg	0,128
001 053 000002 00 00	KANAL DÜBELİ TRUNKING SCREW ANCHOR	KUTU PACK	14000	22,40 kg	0,140
016 053 000006	6 MM BEYAZ DÜBEL 6 MM WHITE DOWEL	KUTU PACK	35000	28 kg	0,330
016 053 000007	7 MM BEYAZ DÜBEL 7 MM WHITE DOWEL	KUTU PACK	25000	15 kg	0,050
016 053 000008	8 MM BEYAZ DÜBEL 8 MM WHITE DOWEL	KUTU PACK	25000	20 kg	0,189



KABLO KROŞELERİ CABLE CROCHET

001 048 090002 00 17	3/13 TEKLİ KABLO KROŞESİ CABLE CROCHET(3/13)	KUTU PACK	500
001 048 090006 00 17	8/28 TEKLİ KABLO KROŞESİ CABLE CROCHET(8/28)	KUTU PACK	500
001 048 090001 00 00	ÇİFTLİ KABLO KROŞESİ (20'LİK) DOUBLE CABLE CROCHET (20)	KUTU PACK	100
001 048 090002 00 00	ÇİFTLİ KABLO KROŞESİ (25'LİK) DOUBLE CABLE CROCHET (25)	KUTU PACK	250
001 048 090003 00 17	16'LİK BORU KELEPÇESİ PIPE CROCHET (16)	KUTU PACK	100
001 048 090004 00 17	20'LİK BORU KELEPÇESİ PIPE CROCHET (20)	KUTU PACK	100
001 048 090005 00 17	25'LİK BORU KELEPÇESİ PIPE CROCHET (25)	KUTU PACK	100



Güvenliğiniz
Önceliğimiz
*Your Safety
Our Priority*

ELEKTRİK İZOLASYON BANTLARI ELECTRICAL INSULATION TAPES

0.13mmx19mmx10yds

KOD CODE	ÜRÜN ADI PRODUCT NAME	ADET QUANTITY	KOLİ ADET PARCEL QUANTITY
065 133 001019	PVC ELEKTRİK İZOLE BANDI-SİYAH (BLACK)	10	500
065 133 011019	PVC ELEKTRİK İZOLE BANDI-BEYAZ (WHITE)	10	500
065 133 161019	PVC ELEKTRİK İZOLE BANDI-KIRMIZI (RED)	10	500
065 133 131019	PVC ELEKTRİK İZOLE BANDI-MAVİ (BLUE)	10	500
065 133 141019	PVC ELEKTRİK İZOLE BANDI-SARI (YELLOW)	10	500
065 133 151019	PVC ELEKTRİK İZOLE BANDI-YEŞİL (GREEN)	10	500
065 133 171019	PVC ELEKTRİK İZOLE BANDI-SARI+YEŞİL (YELLOW+GREEN)	10	500



ZİLLER VE İKAZ SİSTEMLERİ

BELLS AND WARNING SYSTEMS

Hayatı Koruyan Uyarılar, Güvenliğiniz İçin İkaz Sistemleri
Life-Saving Warnings, Warning Systems for Your Safety



YENİ

AKILLI KAPI KILIDI SMART DOOR LOCK

KAPI VE MERDIVEN OTOMAĞI DOOR AND STAIR AUTOMATION

ZIL BUTONU DOORBELL BUTTON

ZIL TRAFOLARI DOORBELL TRANSFORMERS

TELEFON DAĞITIM KUTULARI TELEPHONE DISTRIBUTION BOXES

İKAZ KORNASI WARNING HORN

ALARM KORNA ALARM HORN

YANGIN İHBAR BUTONU FIRE ALARM BUTTON

SIRENS SIRENS

AKILLI KAPI KİLİDİ SMART DOOR LOCK

KOD CODE	ÜRÜN ADI PRODUCT NAME	AMBALAJ PACKING	ADET QUANTITY	KOLİ ADET WEIGHT	HACİM VOLUME
027 112 000010	AKILLI KAPI KİLİDİ SMART DOOR LOCK	KUTU PACK	1	-	-
027 112 000012	KAPI KONTROL SİSTEMİ 1000 HAFIZALI KARTLI METAL GÖVDE DOOR CONTROL SYSTEM METAL BODY WITH 1000 MEMORY CARD	KUTU PACK	1	-	-



KAPI MERDİVEN OTOMATIĞI / DOOR STAIR AUTOMATIC

KOD CODE	ÜRÜN ADI PRODUCT NAME	AMBALAJ PACKING	ADET QUANTITY	KOLİ ADET WEIGHT
027 112 000001	GİZLİ KAPI OTOMATIĞI (DOKUNMATİK)	KUTU PACK	1	20
027 112 000002	GİZLİ KAPI OTOMATIĞI (BASMATİK)	KUTU PACK	1	20
027 112 000007	ELEK. KİLİTLİ (ANAHTARLI) KAPI OTOMATIĞI	KUTU PACK	1	12
027 112 000009	ELEKTRİKLİ KİLİTLİ KAPI OTOMATIĞI (BİLYELİ)	KUTU PACK	1	12
027 112 000003	BUTONLU KAPI OTOMATIĞI	KUTU PACK	1	30
028 112 000004	KAPI OTOMATIĞI (NORMAL)	KUTU PACK	1	30
027 112 000004	BAS-AÇ KAPI OTOMATIĞI (TIRAJLI KİLİT İÇİN)	KUTU PACK	1	-
027 112 000005	MERDİVEN OTOMATIĞI (RAYLI)	KUTU PACK	1	30
027 112 000006	MERDİVEN OTOMATIĞI (NORMAL)	KUTU PACK	1	30

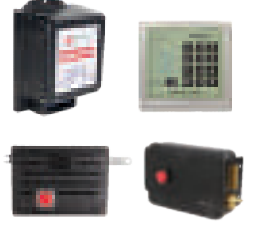

ZİL BUTONLARI / PLASTIC JUNCTION BOXES - CASINGS -

KOD CODE	ÜRÜN ADI PRODUCT NAME	AMBALAJ PACKING	ADET QUANTITY	KOLİ ADET WEIGHT
037 106 020001	1'Lİ ALÜMİNYUM ZİL BUTONU 1.KALİTE	KUTU PACK	1	100
037 106 020002	2'Lİ ALÜMİNYUM ZİL BUTONU 1.KALİTE	KUTU PACK	1	66
037 106 020003	3'LÜ ALÜMİNYUM ZİL BUTONU 1.KALİTE	KUTU PACK	1	56
037 106 020004	4'LÜ ALÜMİNYUM ZİL BUTONU 1.KALİTE	KUTU PACK	1	43
037 106 020005	5'Lİ ALÜMİNYUM ZİL BUTONU 1.KALİTE	KUTU PACK	1	36
037 106 020006	6'Lİ ALÜMİNYUM ZİL BUTONU 1.KALİTE	KUTU PACK	1	32
037 106 020007	7'Lİ ALÜMİNYUM ZİL BUTONU 1.KALİTE	KUTU PACK	1	28
037 106 020008	8'Lİ ALÜMİNYUM ZİL BUTONU 1.KALİTE	KUTU PACK	1	20
037 106 020009	9'LU ALÜMİNYUM ZİL BUTONU 1.KALİTE	KUTU PACK	1	20
037 106 020010	10'LU ALÜMİNYUM ZİL BUTONU 1.KALİTE	KUTU PACK	1	20



ZİLLER VE ZİL TRAFOLARI / PLASTIC JUNCTION BOXES - CASINGS -

KOD CODE	ÜRÜN ADI PRODUCT NAME	AMBALAJ PACKING	ADET QUANTITY	KOLİ ADET WEIGHT
027 105 010012	ZİL TRAFOSU 12 V	KUTU PACK	1	80
027 105 010015	ZİL TRAFOSU 15 V	KUTU PACK	1	40
028 105 020003	KAMPANA ZİL 220 V	KUTU PACK	1	24
028 105 020004	KAMPANA ZİL 12V, 24V, 110V	KUTU PACK	1	24
028 105 020000	MUNZAM ZİL ROLESİ	KUTU PACK	1	100
018 105 000006	KANARYA ZİL (TEK SES)	KUTU PACK	1	50
018 105 000007	KANARYA ZİL (ÜÇ SES)	KUTU PACK	1	50
018 105 000001	TELEFON ZİLİ (AYARLI)	KUTU PACK	1	50
018 105 000002	DİNG DÖNG ZİL ELEKTRONİK (3 SES)	KUTU PACK	1	50



ZİLLER VE ZİL TRAFOLARI / PLASTIC JUNCTION BOXES - CASINGS -

KOD CODE	ÜRÜN ADI PRODUCT NAME	AMBALAJ PACKING	ADET QUANTITY	KOLİ ADET WEIGHT
001 049 001020 00 17	TLF. DĞT. KUTUSU (10 - 20) BOŞ PLS. KLT	KUTU PACK	2	60
001 049 201020 00 17	TLF.DĞT.KUTUSU(10-20)BOŞ PLS.(KİLİTLİ) (A. YAYMAYAN)	KUTU PACK	2	60
001 049 011020 00 17	TLF. DĞT. KUTUSU (10 - 20) BOŞ KİLİTLİ	KUTU PACK	2	60
001 049 211020 00 17	TLF.DĞT.KUTUSU(10-20)BOŞ(KİLİTLİ) (A. YAYMAYAN)	KUTU PACK	2	60
001 049 001050 00 17	TLF. DĞT. KUTUSU(10-50) BOŞ PLS.KİLİT	KUTU PACK	1	28
001 049 201050 00 17	TLF.DĞT.KUTUSU(10-50)BOŞ PLS.(KİLİTLİ) (A. YAYMAYAN)	KUTU PACK	1	28
001 049 011050 00 17	TLF. DĞT. KUTUSU(10-50) KİLİTLİ	KUTU PACK	1	28
001 049 211050 00 17	TLF.DĞT.KUTUSU(10-50)(KİLİTLİ) (A. YAYMAYAN)	KUTU PACK	1	28
001 024 000001 00 00	ÇATI (1 MODÜL İÇİN)	KUTU PACK	1	1000
001 024 000002 00 00	ÇATI (2 MODÜL İÇİN)	KUTU PACK	1	500
001 024 000003 00 00	ÇATI (3 MODÜL İÇİN)	KUTU PACK	1	400
001 024 000004 00 00	ÇATI (4 MODÜL İÇİN)	KUTU PACK	1	300
001 024 000005 00 00	ÇATI (5 MODÜL İÇİN)	KUTU PACK	1	200
001 024 000010 00 00	ÇATI (10 MODÜL İÇİN)	KUTU PACK	1	100
888 049 050001	KESMESİZ MODÜL	KUTU PACK	1	250
888 049 050002	KESMELİ MODÜL	KUTU PACK	10	250
888 049 050003	İRTİBATLAMA ALETİ	KUTU PACK	10	50





Q218 KABLOSUZ KAPI ZİLİ
LEDLİ 100 MT. - 32 MELODİ
2.5 mm² RAIL TERMINAL BLOCKS

Ürün Kodu	Product Code	888 038 218000
Ambalaj Şekli	Packing Type	Kutu - Pack
Adet	Quantity	1
Koli	Weight	10



A-148 KAPI ZİLİ -
32 MELODİ
2.5 mm² RAIL TERMINAL BLOCKS

Ürün Kodu	Product Code	018 105 114800
Ambalaj Şekli	Packing Type	Kutu - Pack
Adet	Quantity	1
Koli	Weight	10



X-581 KAPI ZİLİ -
32 MELODİ
2.5 mm² RAIL TERMINAL BLOCKS

Ürün Kodu	Product Code	018 105 158100
Ambalaj Şekli	Packing Type	Kutu - Pack
Adet	Quantity	1
Ağırlık	Weight	10



WA-628 KAPI ZİLİ - SİYAH
32 MELODİ
2.5 mm² RAIL TERMINAL BLOCKS

Ürün Kodu	Product Code	018 105 162811
Ambalaj Şekli	Packing Type	Kutu - Pack
Adet	Quantity	1
Koli	Weight	10



WA-628 KAPI ZİLİ BEYAZ
32 MELODİ
2.5 mm² RAIL TERMINAL BLOCKS

Ürün Kodu	Product Code	018 105 162800
Ambalaj Şekli	Packing Type	Kutu - Pack
Adet	Quantity	1
Koli	Weight	10



WA-638 KAPI ZİLİ SİYAH
32 MELODİ
2.5 mm² RAIL TERMINAL BLOCKS

Ürün Kodu	Product Code	018 105 163811
Ambalaj Şekli	Packing Type	Kutu - Pack
Adet	Quantity	1
Ağırlık	Weight	10



WA-638 KAPI ZİLİ BEYAZ
32 MELODİ
2.5 mm² RAIL TERMINAL BLOCKS

Ürün Kodu	Product Code	018 105 163800
Ambalaj Şekli	Packing Type	Kutu - Pack
Adet	Quantity	1
Ağırlık	Weight	10

İKAZ KORNASI / PLASTIC JUNCTION BOXES - CASINGS -

KOD CODE	ÜRÜN ADI PRODUCT NAME	AMBALAJ PACKING	ADET QUANTITY	KOLİ ADET WEIGHT
026 112 010001	İKAZ KORNASI 220 V	KUTU PACK	1	45
028 120 000001	İKAZ BUTONU (KARE)	KUTU PACK	2	90



ALARM KORNA VE YANGIN İHBAR BUTONU / PLASTIC JUNCTION BOXES - CASINGS -

KOD CODE	ÜRÜN ADI PRODUCT NAME	AMBALAJ PACKING	ADET QUANTITY	KOLİ ADET WEIGHT
010 090 050050	RESETELEBİLİR BUTON	KUTU PACK	2	90
010 090 050051	RESETELEBİLİR BUTON (KAPAKLI)	KUTU PACK	1	90
028 120 010006	ALARM KORNA PLASTİK	KUTU PACK	1	30
028 120 010005	ALARM KORNA DÖKÜM	KUTU PACK	1	30



SİRENLER / PLASTIC JUNCTION BOXES - CASINGS -

KOD CODE	ÜRÜN ADI PRODUCT NAME	AMBALAJ PACKING	ADET QUANTITY	KOLİ ADET WEIGHT
102 111 000012	LEDLİ FLAŞÖRLÜ ELEKTRONİK SİREN 12V	KUTU PACK	1	25
102 111 000024	LEDLİ FLAŞÖRLÜ ELEKTRONİK SİREN 24V	KUTU PACK	1	25
102 111 000220	LEDLİ FLAŞÖRLÜ ELEKTRONİK SİREN 220V	KUTU PACK	1	25
102 111 000221	LEDLİ FLAŞÖRLÜ ELEKTRONİK SİREN 220V. (YENİ MODEL)	KUTU PACK	1	30
888 111 050004	MS190 MİNİ SİREN (105 db)	KUTU PACK	1	40
026 111 010001	AS. 1 MOTORLU SİREN (PLS.GÖV.)220V,100W (110 db.)	KUTU PACK	1	20
026 111 010002	AS. 2 MOTORLU SİREN (PLS.GÖV.)220V,100W (117 db.)	KUTU PACK	1	12
026 111 010003	AS. 1 MOTORLU SİREN (METAL.GÖV.)220V,100W (115 db.)	KUTU PACK	1	20
026 111 010004	AS. 2 MOTORLU SİREN (METAL.GÖV.)220V,100W (120 db.)	KUTU PACK	1	12
026 111 010005	AS.3 MOTORLU SİREN 220V-280W (130 db.)	KUTU PACK	1	-





Temiz Hava, Ferah Mekanlar
Clean Air, Spacious Spaces



ASPIRATÖRLER

ASPIRATORS



YENİ

ME-FAN ASPIRATÖRLER ME-FAN ASPIRATORS

MUTLUSAN ASPIRATÖR MUTLUSAN ASPIRATOR

MUTLUSAN ME-FAN ASPIRATÖRLER

MUTLUSAN ME-FAN FANS

YENİ
NEW



Temiz Hava, Taze Nefes Me-Fan Aspiratörünüzle Evinizi Yenileyin!
Temiz Hava, Taze Nefes Me-Fan Aspiratörünüzle Evinizi Yenileyin!

100 mm

001 211 000100 00 00



MUTLUSAN ME-FAN 100 ASPIRATÖR

MUTLUSAN ME-FAN 100 FAN



Ambalaj Şekli	Packing Type	Kutu - Box
Adet	Quantity	1
Çalışma Akımı	Operation Voltage	220-240V / 50-60Hz
Emiş Hacmi	Airflow	100 m ³ /h
Devir Hızı	Round Speed	2450 rpm
Ses	Voice	43 dB
Güç	Power	12 W

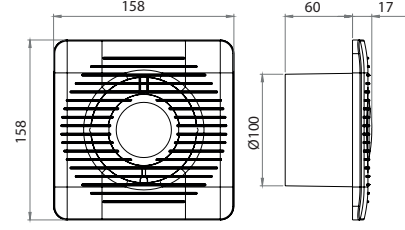

120 mm

001 211 000120 00 00



MUTLUSAN ME-FAN 120 ASPIRATÖR

MUTLUSAN ME-FAN 120 FAN



Ambalaj Şekli	Packing Type	Kutu - Box
Adet	Quantity	1
Çalışma Akımı	Operation Voltage	220-240V / 50-60Hz
Emiş Hacmi	Airflow	120 m ³ /h
Devir Hızı	Round Speed	1900 rpm
Ses	Voice	47 dB
Güç	Power	15 W

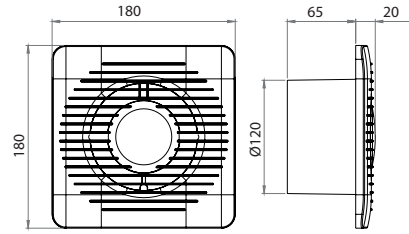

150 mm

001 211 000150 00 00



MUTLUSAN ME-FAN 150 ASPIRATÖR

MUTLUSAN ME-FAN 150 FAN



Ambalaj Şekli	Packing Type	Kutu - Box
Adet	Quantity	1
Çalışma Akımı	Operation Voltage	220-240V / 50-60Hz
Emiş Hacmi	Airflow	150 m ³ /h
Devir Hızı	Round Speed	1350 rpm
Ses	Voice	47 dB
Güç	Power	20 W

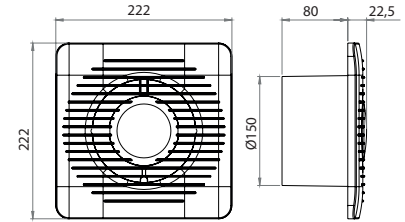

200 mm

001 211 000200 00 00



MUTLUSAN ME-FAN 200 ASPIRATÖR

MUTLUSAN ME-FAN 200 FAN



Ambalaj Şekli	Packing Type	Kutu - Box
Adet	Quantity	1
Çalışma Akımı	Operation Voltage	220-240V / 50-60Hz
Emiş Hacmi	Airflow	200 m ³ /h
Devir Hızı	Round Speed	1200 rpm
Ses	Voice	55 dB
Güç	Power	40 W

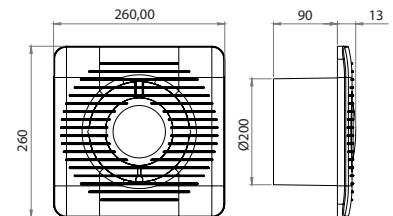

100 mm

001 111 000100 00 00

MUTLUSAN 100 ASPİRATÖR

MUTLUSAN 100 FAN



Ambalaj Şekli	Packing Type	Kutu - Box
Adet	Quantity	1
Çalışma Akımı	Operation Voltage	220-240V / 50-60Hz
Emiş Hacmi	Airflow	100 m ³ /h
Devir Hızı	Round Speed	2450 rpm
Ses	Voice	43 dB
Cüç	Power	12 W

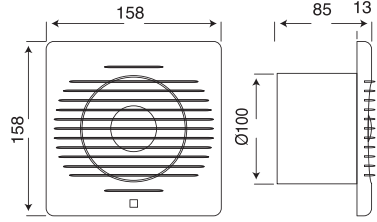

120 mm

001 111 000120 00 00

MUTLUSAN 120 ASPİRATÖR

MUTLUSAN 120 FAN



Ambalaj Şekli	Packing Type	Kutu - Box
Adet	Quantity	1
Çalışma Akımı	Operation Voltage	220-240V / 50-60Hz
Emiş Hacmi	Airflow	120 m ³ /h
Devir Hızı	Round Speed	1900 rpm
Ses	Voice	47 dB
Cüç	Power	15 W

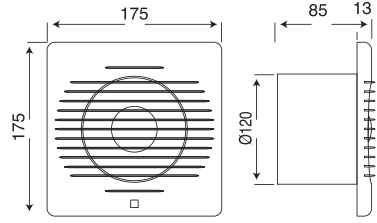

150 mm

001 111 000150 00 00

MUTLUSAN 150 ASPİRATÖR

MUTLUSAN 150 FAN



Ambalaj Şekli	Packing Type	Kutu - Box
Adet	Quantity	1
Çalışma Akımı	Operation Voltage	220-240V / 50-60Hz
Emiş Hacmi	Airflow	150 m ³ /h
Devir Hızı	Round Speed	1350 rpm
Ses	Voice	47 dB
Cüç	Power	20 W

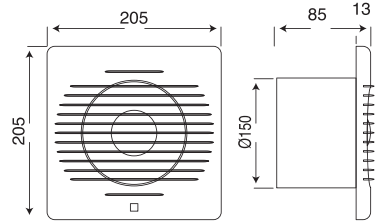

200 mm

001 111 000200 00 00

MUTLUSAN 200 ASPİRATÖR

MUTLUSAN 200 FAN



Ambalaj Şekli	Packing Type	Kutu - Box
Adet	Quantity	1
Çalışma Akımı	Operation Voltage	220-240V / 50-60Hz
Emiş Hacmi	Airflow	200 m ³ /h
Devir Hızı	Round Speed	1200 rpm
Ses	Voice	55 dB
Cüç	Power	40 W

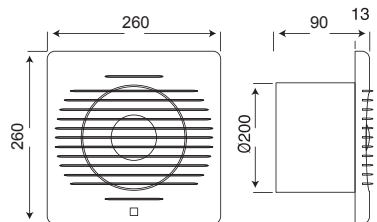



102 038 0008XX - CEXA

FİYAT : 644,20 ₺

*GÖVDE : ABS

*CAM : Polistren (PS) isteğe bağlı Akrilik(PMMA) veya Polycarbon(PC)

*BAŞKI : Akrilik Işık geçirgen Translucent Folyo

*ÇALIŞMA : Acil de ve Şebeke de sürekli çalışma

*PİL : 3.6V 80mAH NiMH (NikelMethalhidrid)

*ŞARJ SÜRESİ : 14-20 Saat

*DEŞARJ SÜRESİ : 180 Dk

*KORUMA SINIFI : IP20

*LED : 4.8mm 6000K Beyaz Mantar Led
veya 2835 6400K EDISON OPTO SMD Led

TÜKETİM : 2 Watt

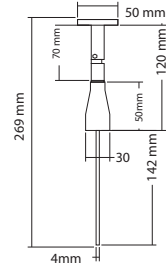
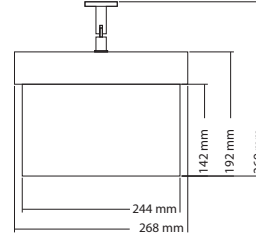

01	02	03	04	05	06	07	08
09	10	11	12	13	14		
15	16	17	18	19	20		
21	22	23	24	25	26		
27	28	29	30	31	32		
33	34	35	36				
37	38	39	40	41	42	43	
44	45	46	47	48	49	50	51
52	53	54	55	56	57	58	59
60	61	62	63	64	65		

*Sipariş Verdiğiniz Ürünün Sembol Kodunu Yazmayı Unutmayınız.

*Ürün Kodunun Son 2 hanesi olan XX Rakamları Ürünün Sembol Kodunu belirtmektedir.



Yeni
MODÜLER SİSTEM
Modular System

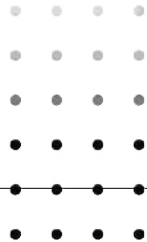

**KOLAY
KULLANIM
YÜKSEK
KALİTE
EASY CONNECTION, HIGH QUALITY**



ŞALT GRUBU

Önceliğiniz
MUTLUSAN'in
A.G. Çözümleri
OLACAK...



“Mutlusan’s Low Voltage solution will be your superiority”

Detaylı Bilgi İçin
For Detailed Information





Mutlusan Plastik Elektrik San ve Tic. A.Ş.

İkitelli Org.San. Bölgesi Mahallesi Enkoop Cad.
No:7 Başakşehir- İstanbul
Tel : +90 (212) 485 05 44 (PBX)
Faks : +90 (212) 485 10 12

Karaköy Şube Karaköy Branch

Okçumusa Cad. Güneşhan İş Hanı No : 24/10
Karaköy-İstanbul
Tel : +90 (212) 237 06 02 (PBX)
Fax: +90 (212) 237 77 47

Perpa Şube Perpa Branch

Perpa Tic. Merkezi. A Blok Kat: 2
No: 9-009 Okmeydanı - İstanbul
Tel : +90 (212) 320 05 78 (PBX)
Fax: +90 (212) 320 05 81

mutlusan.com.tr